

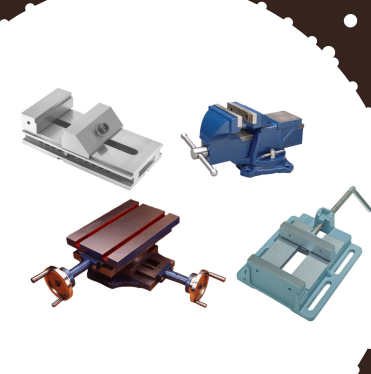

ABM TOOLS

Product Catalogue

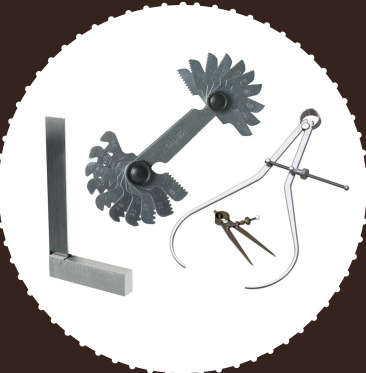

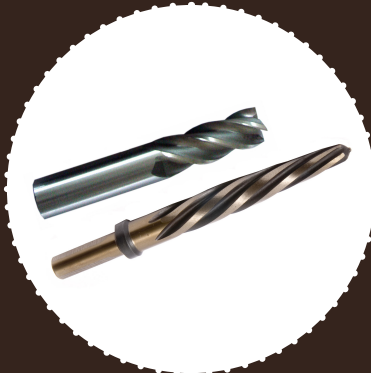

INDEX

Machine Tool Accessories

	Page No.		Page No.
Radius Turning Attachment Ball and Radius Turning Tool	1	VEE Adaptor - For Round Bar	12
Lathe Turning Attachment	1	Live Centre / Revolving Centre (Dual Bearing) (Economy Live Centres)	13
Woodworking Lathe Spindle Adaptor	1	Live Centre / Revolving Centre (Triple Bearing) (Heavy Duty)	13
Ball Turning Attachment	1	Multipoint Live Centre (Precision)	14
Valve Seat & Face Cutter Sets Professional 45 Degree	2	High Precision Live Centres for CNC Lathes (Standard)	14
Woodworking Lathe Spindle Adapter	2	High Precision Live Centres for CNC Lathes (Extended Point)	14
Valve Seat & Face Cutter Sets	2	High Precision Live Centres for CNC Lathes (Low Body)	15
Bench Block	3	High Precision Live Centres for CNC Lathes (Low Body Extended Point)	15
Drill Chucks (With Key)	3	High Precision Live Centres for CNC Lathes (Multipoint)	15
Drill Chuck Keys	3	Tail Stock Quick Change Turret Head with 4 Station	16
Universal Circle Cutter	3	Tail Stock Quick Change Turret Head with 3 Station	16
Drill Chucks (Keyless)	4	Revolving Tailstock Chuck Adaptor for Boxford & Myford Lathe Machine	17
Drill Drift	4	Slow Speed Revolving Center - Live Center	17
Sensitive Drill Attachment	4	Revolving Tailstock Arbor	17
Drill Chucks (with Key)	4	Revolving Center / Live Center With Chuck	17
Micro Sensitive Drill Adaptor	4	Mini Revolving Center Live Center / Revolving Center (Mini)	18
Miniature Quill With JTO Drill Chuck	4	Half Dead Centre (Lathe Centre)	18
Reversible Tapping Attachment	5	Mini Lathe Live Revolving Centre for Peatol & Pultra Lathes	18
Heavy Duty Jack Screw Set	5	Dead Center (Lathe Centre)	18
Machinist Jack (Light Duty)	5	Bull Nose Live Centers	19
Machinist Jacks (Heavy Duty)	5	Bevel Revolving Tube Pipe Centres	19
T Slot Cleaner	5	Taper & Parallel Test Bars / Mandrels	20
Lathe Carriers	6	Straight Shank Arbors (Drill Chuck Arbor)	20
Grinding Carriers (Lathe Dogs)	6	Drill Chuck Arbors (Taper Shank Arbors)	21
File Handles (Wooden)	7	Blank End Arbors	21
File Handles (Plastic)	7	Solid Sockets (Turret Sockets)	22
Tap Guide (Knurled Body)	7	Straight Stub MT Arbor	22
Tap Guide (Spring Centre)	7	Threaded Arbors (Drill Chuck Arbors Threaded)	22
Machine Hand Tap Guide	7	Drill Sleeves (Reduction Sleeves)	23
5C Collet Fixture	8	End Mill Holders	23
BT 40 Tool Holder Locking Device	8	R 8 Drill Chuck Arbors	24
5C Collet Fixture H & V	8	Morse Taper Arbors	24
Drill Stop Set	8	Expanding Arbor - 8 Pcs Set	24
Collet Stop 5C	8	Open End Sleeve with Extractor - DIN 228	24
Solid Collet Stop Adjustable	8	Combination Shell End Mill Adapters / Arbors	25
Work Stop	9	Straight Stub Milling Arbor	25
Quill Stop	9	Face Mill Arbors	25
Quill Feed Handle	9	Extension Sockets	26
Knobs	9	Taper Adapters (Morse Taper Adapter)	26
Independent 4 Jaw Lathe Chuck (Dog Chuck)	10	Screw-In Spare Tangs	27
Self Centering Lathe Chuck (True Chuck) (3 Jaws)	10	Quick Change Chuck Adapter	27
Lathe Chuck Keys	11	Fixed Vertical Slide	27
Safety Self Ejecting Lathe chuck keys	11	Mini Vertical Slide	27
Mini Lathe Chuck With Shanks	11	Mini Vertical Slide	28
Taper Turning Attachment With Dead Center for Lathe Machine	12	Vertical Milling Attachment Slide Swivel Base	28
Taper Turning Attachment With Revolving Center for Lathe Machine	12	Vertical Milling Slides Suitable for ML7 Lathes	28
Taper Turning Attachment	12	Mini Vice - For Rotary Table or Vertical slide	28



INDEX

	Page No.		Page No.
Vertical Sliding Table	29	Micro Boring Head	54
Small Milling Vice For Myford Lathe	29	Automatic Boring Cum Facing Heads	54
Round Vice For Rotary Table or Vertical Slide	29	Axial & Radial Boring Bar for Boring Head	55
Vice For Vertical Table or Vertical Slide	30	Shanks for Boring Heads	56
Quick Change Tool Post Compatible to Mount on MYFORD & Mini Lathes	30	Screw Extractor	57
Mini Quick Change Tool Post Holder Set Aluminium	30		
Quick Change Tool Post Wedge Type	31		
Quick Change Tool Post Set Multifix - 40 Position	32		
Quick Change Tool Post Dixon Type	33		
Quick Change Tool Post C2 & C3 Lathes	33		
Quick Change Tool Post Dual mounting	33		
Quick Change Tool Post Single Mounting	34		
Quick Change Tool Post T2 Size	34		
Quick Change Tool Post T72 / T2	34		
Quick Change Tool Post	34		
Quick Change Tool Post Economy Starter Set	35		
Standard Holders Turning Tool Holders	35		
Boring Holders	35		
Parting Tool Holders	35		
Rocking Tool Posts	36		
Precision Boring Head Kit 75 mm / 3" BT Shank	36		
Precision Boring Head Kit 75 mm / 3" ISO Shank	37		
Precision Boring Head Kit 75 mm / 3" - MT Shank	37		
Precision Boring Head Kit 75 mm / 3" - R8 Shank	38		
Precision Boring Head Kit 62 mm	39		
Precision Boring Head Kit 50 mm / 2" - BT Shank	39		
Precision Boring Head Kit 50 mm / 2" - ISO Shank	40		
Precision Boring Head Kit 50 mm / 2" - MT Shank	41		
Precision Boring Head Kit 50 mm / 2" - R8 Shank	42		
Precision Boring Head Kit 50 mm / 2"	43		
Boring Head Kit 50 mm / 2" - With Shanks	43		
Precision Boring Head Kit 38 mm - MT + Straight Shank	43		
Precision Boring Head Kit 38 mm - MT Shank	44		
Precision Boring Head Kit 38 mm - Straight Shank	45		
Precision Boring Head Kit 38 mm - Straight Shank	46		
Boring Head 38 mm with Shanks	46		
Precision Boring Head Kit 30 mm - MT Shank + Straight Shank	47		
Precision Boring Head Kit 30 mm - MT Shank	48		
Precision Boring Head Kit 30 mm - Straight Shank	48		
Precision Boring Head Kit 30 mm	49		
Boring Head With Shanks 30 mm	50		
Shanks for Mini Boring Heads	50		
Mini Boring Heads	50		
Boring Heads With R8 Integrated Shanks	51		
Precision Boring Heads	51		
Indexable Boring Head	52		
Boring Head Pivot Type	52		
Boring Head Sets	53		
Extension Adapters	53		

Magnetic & Dressing Tools

	Page No.
Single Point Diamond Dresser	58
Low Boy Angle Dressers	58
High Low Adjustable Dressers	58
Cluster Diamond Dressers Multipoint (T Type)	59
Cluster Diamond Dressers Multipoint	59
Diamond Nib Holder	59
Wheel Dressers Emry Wheel Dressers & Cutters (Huntington Type)	60
Hand Diamond Dressers	60
Pocket Magnets - U Magnets - Horse Shoe Magnets	60
Mini Magnetic Stand - Mini Magnetic Base	61
Mini Magnetic Stand - Mini Magnetic Base	61
Power Magnets With T Handle	61
Extra Power Magnetic Hold Fast	61
Button Magnets	62
Magnetic Quick Clamp Multiangle (Magnetic Welders Clamp)	62
Pot Magnets	62
Universal Magnetic Indicator Holder	63
Magnetic Adjustable Links (Magnetic Welding Links)	63
Magnetic Welders Clamp	63
Shallow Ceramic Magnets	64
Magnetic Welding Links	64
Magnetic Squares (Magnetic Welding Square)	64
Magnetic Clamp Set	65
Magnetic Clamps	65
Magnetic Quick Clamp Double	65
Magnetic Ground Clamps	65
Magnetic Base with Safety Shield	66
Magnetic Base (Push Button) (Standard Magnetic Bases)	66
Magnetic Base (High Power)	66
Magnetic Base (High Power) Flexible Arm	67
Magnetic Chuck Parallels and Universal V Blocks	67
Universal Clamps	67
Magnetic V Block Set	68
Magnetic Back for Dial Indicator	68
Magnetic Base Holder	68
Magnetic Chuck (Rectangular)	69
Magnetic Chuck (Round)	69
Universal Mighty Magnetic Base	70
Gage Handle (Universal Pin Gage Handle)	70



INDEX

	Page No.		Page No.
Magnet Cleaner	70	External Tool Holders (Lever Lock)	83
Magnetic Separator	70	External Tool Holders (Screw Clamp)	84
Pocket Magnet	71	External Tool Holders (Top Clamp)	85
Magnetic Swarf Wand	71	Double Ended Boring Bars	85
Bend-It Magnet	71	Double Ended Boring Bars Set	86
Magnetic Holder - With Clip	71	Lathe Boring Tools	86
Magnetic Pickup Tool (Telescopic Pick Up Magnet)	71	Boring Tool Holder - Heavy Duty	86
		Calibrated Boring Bars	87
		Indexable End Mills ST & MT Shanks	87
		Indexable End Mills APKT Inserts	87
		Indexable End Mills TPKN Inserts	87
		Round Tool Holders Double Ended	88
		Turning Tool Bit Holder American Pattern	88
		Turning Tool Bit Holder British / English Pattern	88
		Turning Tool Bit Holder Adjustable	88
		Universal Tool Holder (3 Way Tool Holder)	89
		Mini Turning Tool Holder	89
		Mini Parting Holder Clamp Type	89
		Parting & Groove Holders	89
		Parting Tool Holder Eclipse Type	90
		J & S Type Cut Off Holder (Cut off Tool Holder) (Parting off Holder)	90
		Parting Tool Holder (Cut off Tool Blocks) (Quick Clamp Parting Tool Holder)	90
		Mini Parting Holder	90
		Parting Tool Holder	91
		Parting Tool Holder for Blades	91
		Parting Tool Holder screw Clamping	91
		Parting Tool Holder Screw Clamping	91
		Parting Tool Holder Komet Type	92
		Saw Holder (Saw holder Circular) (Slitting Saw Holder Straight Shank)	92
		Circular Saw Holder Set	92
		R-8 Saw Holder	92
		Stub Milling Arbor for Gear Cutting	93
		Saw & Gear Cutter Holder	93
		Saw Holder Taper Shank & MT Shank	93
		Saw Holder Mini	93
		Knurling Tool Holder Single Ended	94
		Knurling Tool Holder Double Ended	94
		Knurling Tool Holders American Pattern - Two Wheels	94
		Knurling Tool Holders Pivot Head (Two Knurl Wheels)	94
		Knurling Tool Holder Revolving Head 3 Knurl	95
		Knurling Tool Holder 6 knurls	95
		Knurling Tool Holders Multi Head	95
		Hand Knurling Holder	95
		Knurling Tool Holder 3 Interchangeable Heads	96
		Knurling Tool Holder V clamp Type	96
		Knurling Tool Holder Linear	96
		Knurling Tool Holders High Capacity Special	96
		Knurling Tool Holder Adjustable Clamp Type	97
		Knurling Tool Holder Adjustable Clamp Type	97

Tap Wrenches & Die Stock Handle

	Page No.
Die Holder / Handles (Zinc)	72
T. Tap Wrenches / Handle Ratchet Type	72
Die Holder / Handles (MS) (Round Die Stock Handle)	72
Interchangeable Reversible Tap Wrench Holder Set	72
T. Tap Wrenches / Handle (Solid Jaws) (T Handle Tap Wrenches) (Standard Type)	73
T. Tap Wrenches / Handle Replaceable Jaws	73
Piloted Spindle Tap Wrench	73
Extra Long T. Tap Wrenches	74
Tap Extensions	75
Mini Tap Handle	75
Adjustable Tap & Reamer Wrenches / Handles	75
Self Aligning Tap and Reamer Holder (Tap and Reamer Aligner / Holder)	76
Die Adapters	76
T-Tap Wrench - Cam Lock	76
Large Capacity Tap Wrench M4 to M20 Sturdy Tap Wrench	77
Conduit Die Set	77

Tool Holders & Boring Bars

	Page No.
Die Holder (Shank Type)	78
Tail Stock Die Holder Set	78
Tail Stock Die Holder Set	78
Die Holder - Straight Shank	78
Floating Tail Stock Die Holder Set	79
Face Mill Cutters - APKT Inserts	79
Fly Cutter Tool Holder Taper Shank	79
Fly Cutter	80
R-8 Fly Cutter Holder	80
Fly Tool Cutter Holder	80
Indexable Carbide Turning Tool Holder set of 5 Pcs	81
Indexable Carbide Turning Tool Holder set of 7 Pcs	82
Boring Tool Holders (Lever Lock)	82
Boring Tool Holders (Screw ON)	83



INDEX

	Page No.		Page No.
Knurling Tool Holder Adjustable Clamp Type Spring Loaded	97	Adjustable Steel Square	120
Knurling Tool - Quick Acting	98	Bevelled Edge Steel Squares	121
Spare Knurls	98	Precision Steel Squares Flat & Back Base	121

Collets & Holders

	Page No.		Page No.
Shank Types	99	Firm Joint (Odd Leg) Jenny Callipers	122
Collet Holders BT MAS 403 / ER	100	Firm Joint Callipers & Dividers	122
Morse Taper Adaptor BT MAS 403 / MTA	101	Spring Callipers & Dividers Premium quality	122
End Mill Holder (Weldon) BT MAS 403 / SL-SLA	102	Wing Compass	123
Face Mill Arbor BT MAS 403 / FMB	103	Wing Compass (German Type , Square Leg)	123
Comb-Shell / Shoulder Mill Arbor BT MAS 403 / FMC	104	Woodworking Callipers	123
Shell End Mill Arbor BT MAS 403 / SMS	105	Woodworking Callipers Brass Wing Nut	123
Collet Holders SK-DIN 69871 / ER	106	Spring Callipers & Dividers Flat Leg	124
Morse Taper Adaptor SK-DIN 69871 / MTA	107	Quick Release Callipers German Type (Square Leg Spring Divider) (Precision)	124
End Mill Holder (Weldon) DIN 69871 AD	108	Wing Compass (German Type , Square Leg) (Square Leg Pencil Holders - Heavy Duty)	124
Face Mill Arbor SK-DIN 69871 SK / FMB	109	Hermaphrodite Callipers	125
Shoulder Mill Arbor SK-DIN 69871 SK / FMC	110	Spring Divider Interchangeable Points	125
Shell End Mill Arbor SK-DIN 69871 SK / SMS	111	Compass with Pencil Holder	125
Tool Holders for Drill Chucks DIN 69871A	112	Wing Compass With & Without Pencil Holder	125
Tool Holders for Drill Chucks MAS 403 BT	112	Zero Point Setter	126
Collet Holders DIN 6327 C-Tr / ER	113	Economy Micrometer	126
Pull Studs BT MAS 403	113	Micrometer Stand Base (Standard)	126
Pull Studs DIN 69872	114	Brass Vernier Callipers (Sliding Gauge Brass) (Round Jaws)	126
Pull Studs ISO 7388 B	114	Brass Vernier Callipers (Sliding Gauge Brass)	126
Assembling AIDS	115	Vernier Callipers	127
ER Wrenches System DIN 6499	115	Machinist Scraper	127
ER Mini Wrenches	115	Dial Comparator Stand (Fine Adjustments)	127
5C Collet Fixture	116	Triangular Scraper	128
BT40 Tool Holder Locking Device	116	Adjustable Scraper & Deburring Tool	128
5C Collet Fixture H & V	116	Scriber / Scraper (Marking Knife Scriber)	128
Quick Change Chuck Adapter	116	Pocket Scraper	128
Collet Spanner For ER25 / ER32 Collet Holders.	117	Single Point Scriber	128
ER Spring Collet Sets	117	Two Point Scriber	128
Collet Holders	117	Three Point Scriber	128
Collets & Adapter Sets	118	Carbide Scraper	128
		Pocket Scraper - Eclipse Type	129
		Two Fixed Point Scriber	129
		Carbide Scraper - Magnetic Tip	129
		O Ring Hook & Scriber - 2 Pcs Set	129
		Steel Rules	129
		Adjustable Hook Rules	129
		Welding Taper Bore Gauge & Steel Ruler	130
		Drill Point Gauge with Hook Ruler	130
		Model Railroad Ruler	130
		Round Bar Centre Finder	130
		Wigglers Centre Finders	130
		Centre Square	131

Measuring & Marking Tools

	Page No.		Page No.
Adjustable Bevels	119		
Sliding T Bevel Aluminium	119		
Carpenter Try Square Cast Iron	119		
Combination Square	120		
Precision Steel Squares Engineers	120		



INDEX

	Page No.
Engineers Bell Punch Center Finder	131
Electronic Edge Finder	131
Edge & Center Finder Set	131
Edge Finder / Centre Finders	132
Sine Bar Economy	132
Sine Bar Precision	133
V Sine Bar	133
Working Block Pairs	133
Wavy Parallels (Set of 8 Pcs.)	133
Steel Parallels	134
Magnetic Chuck Parallels and Universal V Blocks	134
Engineer's Steel Parallels & Sets	135
Magnetic V Block Set	135
V Block Jig Fixture (For Center Drilling of Round Work)	136
Elongated Vee Blocks	136
Triple Vee Blocks	136
Vee Blocks - Non Protruding	136
Machinist V-Block Set (Tool Maker's)	137
V - Block (Casted)	137
Precision V-Block & Clamp Set (Multi Side Use) (V Block Stepped Groove)	138
Precision V-Block & Clamp (Ultimate) (All Angle)	138
Precision Adjustable Angle Block Sets	138
V - Block Quadruple (Four Way Vee Blocks)	139
Ultra Precision Vee Block (Versatile Vee Block with Clamps)	139
Box Type Angle Plate	139
Vee Angle Blocks & Angle Plate Combined	140
Modular Machine Vice Cum Slotted Table	140
Small Angle Plate for Myford Lathes	140
Slim Angle Plate	140
Stepped Angle Plate	141
Swivel Angle Plates / Table	141
Universal Tilting Tables (Adjustable Angle Plate) (Precision)	141
Slotted Machine Angle Plate (Webbed and Open)	142
Solid Angle Plate	142
Right Angle Iron Plate	142
Tilting Tables (Adjustable Angle Plate)	143
Surface Plate (Cast Iron & Graphite)	143
Surface Plate Box Type (Cast Iron)	144
Engineer's Precision Sets (6 Pcs.)	144
Engineer's Tool Kit (11 Pcs.)	144
Precision Tools Set (11 Pcs.)	145
Precision Steel Squares Sets (4 Pcs.)	145
Edge & Center Finder Set (5 Pcs.)	145
Center Square & Precision Square Kit (6 Pcs.)	146
Center Square & Precision Square Kit (6 Pcs.)	146

Gauges

	Page No.
Protractor (Degree Protractors)	147
Twist Drill Grinding Gauge	147
Protractor Cum Depth Gauge	147
Multipurpose Angle Protractor	147
Depth Gauge	147
Bore Gauge	148
Dial Bore Gauge	148
Welding Taper Bore Gauge and Steel Ruler	148
Wire Gauge / Wire Gage (Round and Rectangular)	148
Drill Gauge	148
Feeler Gauge (Thickness Gauge)	149
Radius Gauge (Ring Type)	149
Center Gauge	149
Radius Gauge (Locking Type)	149
Radius Gauge - Weld Gauge	149
Screw Pitch Gauge	150
Screw Pitch Gauge (Triangular)	150
Vernier Height Gauge	151
Screw Cutting Gauge	151
Acme Screw Cutting Gauge	151
Marking Gauge	151
Protractor (Degree Protractors) Half Moon	151
Twist Drill Grinding Gauges	152
Universal Grinding Gauges	152
Drill Point Gauge with Hook Ruler	152
Surface Gauge Tool Makers (Surface Marking Block / Gauges)	152
Surface Marking Blocks / Gauges Round Base	153
Tire Tread Feeler Gauge Double Point Brass	153
Brass Tyre Profile Depth Gauge (Profile Depth Gauge Brass)	153
Tire Tread Feeler Gauge Single Point Brass	153

Punches

	Page No.
Automatic Centre Punches	154
Automatic Centre Punches (Heavy Duty) (Marking Punch)	154
Automatic Center Punch with clip	155
Drive Pin Punches 4 Inch Long (Short Drive Pin Punches)	155
Drive Pin Punch - Hexagonal	155
Drive Pin Punches 6 Inch	156
Drive Pin Punches 8 Inch (Long Drive Pin Punches)	156
Drive Pin Punches (Heavy) 8 Inch (Long Drive Pin Punches)	157
Parallel Pin Punches Short Reach	157
Parallel Pin Punches Long Reach	158
Rolling Pin Punch Set	158
Grommet Setting Dies	158
Brass Pin Punches (Non Sparking)	159
Centre Punches (Square and Round Head)	159



INDEX

	Page No.		Page No.
Center Punch set of 7	160	Chain Pipe Vice	174
Prick Punches (Light)	160	Pipe Vice Stand (Self Locking Pipe Vice)	175
Centring Punch (Hinge Centering Punch)	160	Pipe Vice (Self Locking)	175
Taper Punches (Aligning Punches)	160	Pipe Vice (Open Type)	176
Prick Punches (Heavy)	161	Pipe Vice (Round Pillar)	176
Interchangeable Hollow Punch Set of 10 Pcs.	161	Pipe Vice (Unbreakable, SG Iron Body) (Open Type Replaceable Jaws)	176
Starting Punches (Heavy Duty)	161	Pipe Vice (Pillar Type, Changeable Jaws)	176
Revolving Punch Plier	161	Bench & Drill Press Vice Multifunction	177
Arch Punches DIN 7200A	162	Multipurpose Bench Vice	177
Leather Punch (Hollow Punches) (Belt Punches)	163	Armature Bearing Puller Vice (Heavy Duty)	177
Nail Punches (Square and Round Head)	164	Self Centring Shaft Vice (Crank Shaft Vice)	177
Letter & Number Punches (Set) (Letter and Number Sets) (Steel Stamps)	164	Bench Vice (Fixed Base)	178
Optical Center Punch Set	165	Bench Vice (Swivel Base)	178
Wad Punch Kit	165	Bench Vice (Fixed Base) (All Steel)	178
Wad Punch Kit	165	Bench Vice (Swivel Base) (All steel)	179
Gasket Punching Table	165	Bench Vice (Precision Tool Room Bench Vice) (German Type)	179
Transfer Punches	166	Drill Vice German Type	179
Universal Transfer Punch & Aligner	166	Offset Steel Bench Vice	179
Utility Punch & Scriber	166	Off Center Bench Vice	180
13 Pc combo Pin Punch Set	167	Drill Press Vice Moveable Jaw	180
14 Pc combo Punch Set	167	Precision 3 Way Universal Drill Press Vises	180
Punch & Chisel Holder	167	Quick Release Steel Vice	180
		Tilting Jaw Drill Press Vises	181
		Precision 3 Way Drill Vice Uni-Grip	181
		Quick Acting Vises	181
		Quick Change Precision Vice	181
		Drill Press Vice (Heavy Duty)	182
		Drill Press Vice (Grinding Vice) (Multisided Use)	182
		Drill Press Vice (Precision)	182
		Drill Vice Precision	182
		Drill Press Vice	183
		Drill Machine Vice	183
		Universal Compound Vice	183
		Compound Slide Vice Precision (X / Y Axis)	184
		Precision Tool Makers Vice	184
		Toolmaker's Precision Screwless Vice	184
		Precision Grinding Vice (Tool Maker's Precision Steel Vice)	185
		Precision Grinding Vice	185
		Precision Sine Vice (Lead Screw Type)	185
		Precision Sine Vice (Screwless Type - Pin Type)	185
		Magic Vises	186
		Precision Grinding Control Vice	186
		Polygon Machine Vice	186
		Precision Mini Tilt & Swivel Base Vice	187
		Rotary Head Vice (Swivel Base)	187
		Hydraulic Machine Vice (Fixed Base) (Hydraulic Power)	187
		Hydraulic Machine Vice (Swivel Base) (Hydraulic Power)	187
		Hydraulic Machine Vice (Heavy Duty) (Fixed & Swivel Base)	188
		Tilt Lock Machine Vice (Swivel Base) (Kurt Type)	188

Work Holding Device

	Page No.
Anvil - Cast Iron	168
G Clamp (Ductile) (C Clamp)	168
G Clamp (Drop Forged) (C Clamp)	168
G Clamp (Sheeted / Welded / Pressed) (C Clamp)	169
Corner Clamps	169
Corner Vice Self Centering	169
T Bar Cramps (T Bar Clamps)	169
F Clamps (F Bar Cramps)	170
Parallel Clamps (Toolmaker's)	170
Bearing Puller (2 & 3 Legs)	170
Clamping Kits	171
Woodworking Vice Record Type	172
Woodworking Vice (Wood Workers Vice) (Quick Release)	172
Woodworking Vice (Wood Workers Vice)	172
Hand Vice with Wing Nut	172
Leg Vice	173
Hand Vice	173
Draw Vice	173
Baby Vice (Swivel Base)	173
Baby Vice (Fixed Base)	174
Baby Vice (Fixed Base) (Table Vice) (Baby Bench Vice)	174
Baby Vice (Swivel Base) (Table Vice) (Baby Bench Vice)	174



INDEX

	Page No.		Page No.
Tilt Lock Machine Vice (Fixed Base) (Kurt Type)	189	Rotary Table Tilting MT2 - 4" / 100 mm	205
Tilt Lock Down Machine Vice (Kurt Type - Fixed Base - Precision)	189	Rotary Table Tilting - 4" / 100 mm	205
Tilt Lock Hydraulic Vice (Precision)	190	Rotary Table Tilting - 4-3/8" / 110 mm	206
Tilt Lock Down Self Centring Vice (Angle Lock Self Centering Vice)	190	Rotary Table Horizontal & Vertical - 4-3/8" / 110 mm	206
Precision Quick Setting Machine Vice	191	Rotary Table Horizontal & Vertical - 5" / 125 mm	206
Dual Station Vice (Precision)	191	Rotary Table Tilting - 6" / 150 mm	207
Precision Tilt Lock Down Machine Vice (Kurt Type - Fixed Base - Rear Jaws)	192	Rotary Table Horizontal & Vertical - 6" / 150 mm	207
Modular Precision Machine Vice with Parallel Top Jaws	192	Rotary Table Horizontal & Vertical - 8" / 200 mm	207
Precision High Grip Shaft Vice Self Centering	193	Rotary Milling Table (Rotary Milling Table Horizontal & Vertical System)	208
Precision Multigrip Machine Vice Serrated Slide Ways	193	Rotary Table Set For Watchmaker's, Jewellery, Milling Size 2-3/4" / 68 mm	208
Wedge Clamps (Used in Precision Multigrip Machine Vice Serrated Slide Ways)	193	Rotary Table 3" Tilting Set	209
Precision Self Centering Vice 5 Axis	194	Rotary Table 3" Set (With 3 or 4 Jaws Chuck)	209
Precision High Grip Machine Vice	194	Rotary Table 4" Set (with Tailstock, Clamping Kit & Chuck)	209
Precision High Grip Machine Vice Self Centering	194	Rotary Table 4" Tilting Set	210
Modular Precision Milling Vice	195	Rotary Table 4" Set (With 3 or 4 Jaws Chuck)	210
Two Piece Modular Precision Milling Vice	195	Rotary Table 5" Set	210
2 Pc Milling Machine Vice	195	Rotary Table Set HV4	211
Precision Machine Vice Fixed Base - Heavy Duty	196	Rotary Table Set HV4 (4-3/8" / 110 mm)	211
Precision Machine Vice Swivel Base - Heavy Duty	196	Rotary Table Set HV6 With Chuck	212
Precision Machine Vice (Swivel Base)	196	Rotary Table Set HV6 - Rotary Table, Tailstock & Indexing Plates Set	212
Self Centering Vice (Fixed Base)	197	Vice For Rotary Table or Vertical Slide	213
Self Centring Vice Precision	197	Mini Vice For Rotary Table or Vertical Slide	213
Unigrip Machine Vice (Heavy Duty - Precision)	197	Small Milling Vice Myford Lathe	213
Self Centering Vice (Swivel Base)	197	Round Vice For Rotary Table or Vertical Slide	213
Milling Machine Vice (Fixed Base)	198	T NUTS For Rotary Table	214
Milling Machine Vice (Swivel Base)	198	Clamping Kits - 24 Pcs. For Rotary Table	214
Tilting & Swivelling Vice (J & S Type, England Type) (Precision)	198	Clamping Kits For Rotary Table	214
Milling Machine Vice (Fixed Base) (J & S Type, England Type) (Precision)	199	Clamping Kits For Rotary Table	214
Milling Machine Vice (Swivel Base) (J & S Type, England Type) (Precision)	199	Collet Chuck Adapter (For Rotary Table)	215
Universal Vice (Universal Machine Vice)	199	Dividing Plate Sets	215
2 Way Universal Tilting & Swivelling Angle Vice (Machine Vice)	200	Dividing Plate Sets	215
3 Way Universal Tilting & Swivelling Angle Vice (Machine Vice)	200	Adjustable Tail Stock For Rotary Table 8" / 200 mm	215
Compound Sliding Table (Milling and Drilling Table)	200	Adjustable Tail Stock Mini Tailstock	216
Shaper Vice (Fixed Base)	201	Mini Tailstock Tilting	216
Shaper Vice (Swivel Base)	201	Adjustable Tailstock For Rotary Table HV4, HV5 & HV6	216
Universal Dividing Head	201	Adjustable Tailstock For Rotary Tables	216
Universal Dividing Head (Complete With Gear Head)	202	Aluminium Back Plates	217
Indexing Milling Fixture (Horizontal & Vertical)	202	Back Plates	217
Tilting Indexing Device	203	Lathe Chuck Self Centering	217
Modular Machine Vice Cum Slotted Table	203	Lathe Chuck Independent	218
Horizontal & Vertical Two Direction Rapid Indexer	203	Lathe Chuck - Self Centering	218
Rotary Table Square Base 2 Slot - 98 mm	204	Mini Universal Metal Bender	219
Rotary Table For Watchmaker's, Jewellery, Milling - 2-3/8"	204	Mini Rolling and Bending Machine	219
Rotary Table Horizontal & Vertical - 3" / 75 mm	204	Mini Bending Brake Aluminium	219
Rotary Table Tilting - 3" / 75 mm	204	Plate Bench Shear	220
Rotary Table Horizontal & Vertical - 4" / 100 mm	205	Plate Bench Shear Spring Type	220
		Portable Hand Shear	220



INDEX

Pin Vices & Pin Chuck Set

	Page No.
Hand Vice with Wing Nut	221
Hand Drill Pin Vice (Push Drill)	221
Mini Brass Drill Pin Vice	221
Master Pin Vice (Hand Drill Pin Vice with Swivel Head)	221
Double Collet Pin Vice	221
Square Chuck Pin Vice	221
Brass Pin Vice (Mini Pin Vice)	221
Double Collet Pin Vice (American Type)	221
Triangular Pin Vice	221
Small Hand Vice (Hollow Wire Vice)	222
Graver Pin Vice	222
Pin Vice Sliding	222
Pick Up Tools	222
Pin Chuck Set	222
Adapter Pin Chuck Set	222
Single Ended Pin Vices	222
Mini Vice Brass Jaws	223
Wooden File Handle with Brass Collet	223
Pin Tong	223
Pin Vice Wooden Handle	223
Micro Chuck - Micro Pin Chuck	223

Lubrication Equipments

	Page No.
Aluminium Oil Glass Windows	224
Oil Windows (Oil Level Indicators)	224
Grease Nipples	224
Grease Cups (Nut Type)	224
Grease Cups (Moto Type)	224
Grease Nipple (Pin Type)	225
Oil Hole Cover (Drive Fit)	225
Press Button Oiler (Drive Fit)	225
Spring Lid Oil Cups and Elbow Oiler	225
Spring Lid Small Oiler	225
Brass Oil Gauge Heavy	226
Brass Oil Gauge Light	226
Constant Level Oiler	226
Drop Sight Feed Oil Lubricator (Drip Feed Oiler)	227
Hydraulic Coupler (Pin Type)	227
Hydraulic Flexible Connectors (Z Type Couplers)	227
Hydraulic Couplers	227
Grease Guns (Lever Type) (Italian Model)	228
Grease Guns (Lever Type) (3 Way Loading)	228
Grease Guns (Lever Type) (Cat Filling)	228

	Page No.
Grease Guns (Lever Type) (32 Oz)	228
Grease Guns (Lever Type) (Cat Filling) (Heavy)	228
Grease Guns (Lever Type) (10 Oz)	228
Grease Guns (Lever Type) (Variable Stroke) (Heavy Duty)	229
Grease Guns (Lever Type - with Cast Head) (15 Oz)	229
Grease Guns (Lever Type - with Cast Head) (8 Oz)	229
Grease Guns (Lever Type - with Cast Head) (15 Oz Heavy Duty)	229
Grease Guns (Lever Type - with Cast Head) (10 Oz)	229
Grease Guns (Lever Type - with Steel Head) (15 Oz)	229
Grease Guns (Lever Type - with Steel Head) (500 Gms.)	230
Grease Guns (Pistol Type) (Mini)	230
Grease Guns (All Die Cast Head) (3 Way Loading)	230
Grease Guns (Pistol Type) (Professional-Mini)	230
Grease Guns (Pistol Type) (Cat Filling) (Heavy) (Aluminium Die Cast Head)	230
Grease Guns (Push Type) (Bed Ford Type)	230
Grease Guns (Lever Type) (Mini)	231
Oil Cans (Perfecto Type) (Perfecto Type Oiler)	231
Oil Cans (Pint Type) (Pint Type Oiler)	231
Oil Cans (Pistol Type)	231
Oil Can - Snap Type	232
Suction Guns / Suction Pumps (Style 1)	232
Suction Guns / Suction Pumps (Style 2)	232
Suction Guns / Suction Pumps (Style 3)	232
Suction Guns / Suction Pumps (Style 4)	232
Suction Guns / Suction Pumps (Style 5)	232
Transfer Pump (Transfer Gun)	233
Barrel Pump (Light Duty)	233
Oil Gun	233
Hand Rotary Pump (Barrel Type)	233
Barrel Pump (Lever Type)	233

Cutting Tools

	Page No.
Boring Tools (Carbide Tipped)	234
Boring Tools (HSS)	235
Boring & Threading Tools (HSS) (Round Shank)	236
Boring Tools (HSS) (Square Shank)	237
HSS Threading Tool Double Ended 2 Pcs. Set	237
HSS Lathe Turning Tools Set of 6 Pcs.	237
HSS Lathe Turning Tools Set of 8 Pcs.	238
HSS Threading Tool Set of 2 Pcs	238
Indexable Carbide Turning Tool Holder Set of 5 Pcs.	239
Indexable Carbide Turning Tool Holder Set of 7 Pcs.	240
Carbide Brazed Turning Tools Set of 6 Pcs.	240
Carbide Brazed Turning Tools Set of 11 Pcs.	241



INDEX

	Page No.
Carbide Brazed Turning Tools Set of 6 Pcs.	241
Solid Cap Screw Counter Bore	242
Adjustable Scraper & Deburring Tool	242
Countersink & Deburring Tools (Zero Flute)	243
Single Flute Countersinks - HSS	243
Three Flute Countersinks - HSS	244
Six Flute Countersinks	244
Handy Burr	245
Combined Drill and Countersinks (Centre Drills)	245
Cut Of Blades (Parting Tool Bits)	246
Tool Bits (Square, Round and Rectangular Tool Bits)	247
Hand Taps (Carbon Steel & HSS)	248
Round Dies (Carbon Steel & HSS Quality)	249
Conduit Die Set	249
Die Adapters	250
Tap & Round Die Sets - Complete	250
Indexable End Mills TPKN Inserts	251
Indexable End Mills ST & MT Shanks	251
Indexable End Mills APKT Inserts	252
End Mill Cutters (Single End)	252
End Mill Cutters (Double End)	253
Miniature Double End Mills (3/16 " Shank)	254
End Mill Cutters Taper Shank	255
Parallel Shank End Mill Cutters	256
Slot Milling Cutters Parallel Shank	259
Involute Gear Cutter Set HSS B.S. 2518-1954	260
Adjustable Hand Reamer	260
Repairman's Taper Reamer	261
Machine Reamers - HSS (Taper Shank)	262
Parallel Hand Reamers - HSS	263
Chucking Reamer (Straight Shank and Taper Shank) As Per ANSI B94.2	265
Taper Pin Reamers ANSI B94.2	267
Morse Taper Reamer (Socket Reamer) (Morse Taper Finishing / Roughing Reamer)	268
Taper Pipe Reamers ANSI B94.2	268
Single Angle Shank Type Cutter (Chamfer Cutter) (Inverted Dovetail Cutters / Chamfer Cutter)	269
Dovetail Milling Cutter (Single Angle Dovetail Cutter) (Single Angle Shank Type Cutter)	270
Double Angle Shank Type Cutters	270
T Slot Cutters (Taper Shank and Parallel Shank)	271
Face Mill Cutters APKT Inserts	271
Radius Shank Type Cutters (Concave & Convex)	272
Woodruff Cutter (Woodruff Key Slot Cutter and Woodruff Key Seat Cutter)	272
Valve Seat & Face Cutters Sets (Professional 45 Degree)	274
Valve Seat & Face Cutters Sets	274



INDEX

Alphabetical Order

	Page No.		Page No.
13 Pc combo Pin Punch Set	167	Beam Trammel	121
14 Pc combo Punch Set	167	Bearing Puller (2 & 3 Legs)	170
2 Pc Milling Machine Vice	195	Belt Punches (Hollow Punches) (Leather Punches)	163
2 Way Universal Tilting & Swivelling Angle Vice (Machine Vice)	200	Bench & Drill Press Vice Multifunction	177
3 Way Tool Holder (Universal Tool Holder)	89	Bench Block	3
3 Way Universal Tilting & Swivelling Angle Vice (Machine Vice)	200	Bench Vice (Fixed Base)	178
5C collect Fixture H & V	116	Bench Vice (Fixed Base) (All Steel)	178
5C Collet Fixture	8	Bench Vice (Precision Tool Room Bench Vice) (German Type)	179
5C Collet Fixture	116	Bench Vice (Swivel Base)	178
5C Collet Fixture H & V	8	Bench Vice (Swivel Base) (All steel)	179
Acme Screw Cutting Gauge	151	Bend-It Magnet	71
Adapter Pin Chuck Set	222	Bevel Revolving Tube Pipe Centres	19
Adjustable Bevels	119	Bevelled Edge Steel Squares	121
Adjustable Angle Plate (Tilting Table)	143	Blank End Arbors	21
Adjustable Angle Plate (Universal Tilting Tables) (Precision)	141	Bore Gauge	148
Adjustable Hand Reamer	260	Boring & Threading Tools (HSS) (Round Shank)	236
Adjustable Hook Rules	129	Boring Head 38 mm with Shanks	46
Adjustable Scraper & Deburring Tool	128	Boring Head Kit 50 mm / 2" - With Shanks	43
Adjustable Scraper & Deburring Tool	242	Boring Head Pivot Type	52
Adjustable Steel Square	120	Boring Head Sets	53
Adjustable Tail Stock For Rotary Table 8" / 200 mm	215	Boring Head With Shanks 30 mm	50
Adjustable Tail Stock Mini Tailstock	216	Boring Heads With R8 Integrated Shanks	51
Adjustable Tailstock For Rotary Table HV4, HV5 & HV6	216	Boring Holders	35
Adjustable Tailstock For Rotary Tables	216	Boring Tool Holder - Heavy Duty	86
Adjustable Tap & Reamer Wrenches / Handles	75	Boring Tool Holders (Lever Lock)	82
Aligning Punches (Taper Punches)	160	Boring Tool Holders (Screw ON)	83
Aluminium Back Plates	217	Boring Tools (Carbide Tipped)	234
Aluminium Oil Glass Windows	224	Boring Tools (HSS)	235
Angle Lock Self Centering Vice (Tilt Lock Down Self Centering Vice)	190	Boring Tools (HSS) (Square Shank)	237
Anvil - Cast Iron	168	Box Type Angle Plate	139
Arch Punches DIN 7200A	162	Brass Oil Gauge Heavy	226
Armature Bearing Puller Vice (Heavy Duty)	177	Brass Oil Gauge Light	226
Assembling AIDS	115	Brass Pin Punches (Non Sparking)	159
Automatic Boring Cum Facing Heads	54	Brass Pin Vice (Mini Pin Vice)	221
Automatic Center Punch with clip	155	Brass Tyre Profile Depth Gauge (Profile Depth Gauge Brass)	153
Automatic Centre Punches	154	Brass Vernier Callipers (Sliding Gauge Brass)	126
Automatic Centre Punches (Heavy Duty) (Marking Punch)	154	Brass Vernier Callipers (Sliding Gauge Brass) (Round Jaws)	126
Axial & Radial Boring Bar for Boring Head	55	BT 40 Tool Holder Locking Device	8
Baby Bench Vice (Table Vice) (Baby Vice - Fixed Base)	174	BT40 Tool Holder Locking Device	116
Baby Bench Vice (Table Vice) (Baby Vice - Swivel Base)	174	Bull Nose Live Centers	19
Baby Vice (Fixed Base)	174	Button Magnets	62
Baby Vice (Fixed Base) (Table Vice) (Baby Bench Vice)	174	Calibrated Boring Bars	87
Baby Vice (Swivel Base)	173	Carbide Scraper	128
Baby Vice (Swivel Base) (Table Vice) (Baby Bench Vice)	174	Carbide Scraper - Magnetic Tip	129
Back Plates	217	Carbide Brazed Turning Tools Set of 11 Pcs.	241
Ball Turning Attachment	1	Carbide Brazed Turning Tools Set of 6 Pcs.	240
Barrel Pump (Lever Type)	233	Carbide Brazed Turning Tools Set of 6 Pcs.	241
Barrel Pump (Light Duty)	233	Carpenter Try Square Cast Iron	119



INDEX

Alphabetical Order

	Page No.		Page No.
Center Gauge	149	Diamond Nib Holder	59
Center Punch set of 7	160	Die Adapters	76
Center Square & Precision Square Kit (6 Pcs.)	146	Die Adapters	250
Center Square & Precision Square Kit (6 Pcs.)	146	Die Holder (Shank Type)	78
Centre Square	131	Die Holder - Straight Shank	78
Centre Drills (Combined Drill and Countersinks)	245	Die Holder / Handles (MS) (Round Die Stock Handle)	72
Centre Punches (Square and Round Head)	159	Die Holder / Handles (Zinc)	72
Centring Punch	160	Dividing Plate Sets	215
Chain Pipe Vice	174	Dividing Plate Sets	215
Chamfer Cutter (Inverted Dovetail Cutters / Chamfer Cutter) (Single Angle Shank Type Cutter)	269	Double Angle Shank Type Cutters	270
Chucking Reamer (Straight Shank and Taper Shank) As Per ANSI B94.2	265	Double Collet Pin Vice	221
Circular Saw Holder Set	92	Double Collet Pin Vice (American Type)	221
Clamping Kits	171	Double Ended Boring Bars	85
Clamping Kits - 24 Pcs. For Rotary Table	214	Double Ended Boring Bars Set	86
Clamping Kits For Rotary Table	214	Dovetail Milling Cutter (Single Angle Dovetail Cutter) (Single Angle Shank Type Cutter)	270
Clamping Kits For Rotary Table	214	Draw Vice	173
Cluster Diamond Dressers Multipoint	59	Drill Drift	4
Cluster Diamond Dressers Multipoint (T Type)	59	Drill Gauge	148
Collet Chuck Adapter (For Rotary Table)	215	Drill Sleeves (Reduction Sleeves)	23
Collet Holders	117	Drill Chuck Arbor (Straight Shank Arbors)	20
Collet Holders BT MAS 403 / ER	100	Drill Chuck Arbors (Taper Shank Arbors)	21
Collet Holders SK-DIN 69871 / ER	106	Drill Chuck Keys	3
Collet Holders DIN 6327 C-Tr / ER	113	Drill Chucks (Keyless)	4
Collet Spanner For ER25 / ER32 Collet Holders.	117	Drill Chucks (With Key)	3
Collet Stop 5C	8	Drill Chucks (with Key)	4
Collets & Adapter Sets	118	Drill Chuk Arbors Threaded (Threaded Arbors)	22
Combination Shell End Mill Adapters / Arbors	25	Drill Machine Vice	183
Combination Square	120	Drill Point Gauge with Hook Ruler	130
Combined Drill and Countersinks (Centre Drills)	245	Drill Point Gauge with Hook Ruler	152
Comb-Shell / Shoulder Mill Arbor BT MAS 403 / FMC	104	Drill Press Vice	183
Compass with Pencil Holder	125	Drill Press Vice (Grinding Vice) (Multisided Use)	182
Compound Slide Vise Precision (X / Y Axis)	184	Drill Press Vice (Heavy Duty)	182
Compound Sliding Table (Milling and Drilling Table)	200	Drill Press Vice (Precision)	182
Concave & Convex Cutter (Radius Shank Type Cutters)	272	Drill Press Vise Moveable Jaw	180
Conduit Die Set	77	Drill Stop Set	8
Conduit Die Set	249	Drill Vice German Type	179
Constant Level Oiler	226	Drill Vice Precision	182
Corner Clamps	169	Drip Feed Oiler (Drop Sight Feed Oiler)	227
Corner Vice Self Centering	169	Drive Pin Punch - Hexagonal	155
Countersink & Deburring Tools (Zero Flute)	243	Drive Pin Punches 4 Inch Long (Short Drive Pin Punches)	155
Crank Shaft Vice (Self Centering Shaft Vice)	177	Drive Pin Punches 6 Inch	156
Cut Of Blades (Parting Tool Bits)	246	Drive Pin Punches (Heavy) 8 Inch (Long Drive Pin Punches)	157
Cut Off Tool Blocks (Parting Tool Holder) (Quick Clamp Parting Tool Holder)	90	Drive Pin Punches 8 Inch (Long Drive Pin Punches)	156
Cut off Tool Holder (Parting Off Holder) (J & S Type Cut Off Holder)	90	Drop Sight Feed Oil Lubricator (Drip Feed Oiler)	227
Dead Center (Lathe Centre)	18	Dual Station Vice (Precision)	191
Depth Gauge	147	Economy Micrometer	126
Dial Bore Gauge	148	Edge & Center Finder Set	131
Dial Comparator Stand (Fine Adjustments)	127	Edge & Center Finder Set (5 Pcs.)	145



INDEX

Alphabetical Order

	Page No.		Page No.
Edge Finder / Centre Finders	132	Grease Cups (Moto Type)	224
Electronic Edge Finder	131	Grease Cups (Nut Type)	224
Elongated Vee Blocks	136	Grease Guns (All Die Cast Head) (3 Way Loading)	230
End Mill Cutters (Double End)	253	Grease Guns (Lever Type - with Cast Head) (10 Oz)	229
End Mill Cutters (Single End)	252	Grease Guns (Lever Type - with Cast Head) (15 Oz Heavy Duty)	229
End Mill Cutters Taper Shank	255	Grease Guns (Lever Type - with Cast Head) (15 Oz)	229
End Mill Holder (Weldon) BT MAS 403 / SL-SLA	102	Grease Guns (Lever Type - with Cast Head) (8 Oz)	229
End Mill Holder (Weldon) DIN 69871 AD	108	Grease Guns (Lever Type - with Steel Head) (15 Oz)	229
End Mill Holders	23	Grease Guns (Lever Type - with Steel Head) (500 Gms.)	230
Engineer's Precision Sets (6 Pcs.)	144	Grease Guns (Lever Type) (10 Oz)	228
Engineer's Tool Kit (11 Pcs.)	144	Grease Guns (Lever Type) (3 Way Loading)	228
Engineer's Steel Parallels & Sets	135	Grease Guns (Lever Type) (32 Oz)	228
Engineers Bell Punch Center Finder	131	Grease Guns (Lever Type) (Cat Filling)	228
ER Mini Wrenches	115	Grease Guns (Lever Type) (Cat Filling) (Heavy)	228
ER Spring Collet Sets	117	Grease Guns (Lever Type) (Italian Model)	228
ER Wrenches System DIN 6499	115	Grease Guns (Lever Type) (Mini)	231
Expanding Arbor - 8 Pcs Set	24	Grease Guns (Lever Type) (Variable Stroke) (Heavy Duty)	229
Extension Adapters	53	Grease Guns (Pistol Type) (Cat Filling) (Heavy) (Aluminium Die Cast Head)	230
Extension Sockets	26	Grease Guns (Pistol Type) (Mini)	230
External Tool Holders (Lever Lock)	83	Grease Guns (Pistol Type) (Professional-Mini)	230
External Tool Holders (Screw Clamp)	84	Grease Guns (Push Type) (Bed Ford Type)	230
External Tool Holders (Top Clamp)	85	Grease Nipple (Pin Type)	225
Extra Long T. Tap Wrenches	74	Grease Nipples	224
Extra Power Magnetic Hold Fast	61	Grinding Carriers (Lathe Dogs)	6
F Clamps (F Bar Cramps)	170	Grinding Vice - Multisided Use (Drill Press Vice)	182
F Cramps (F Clamps)	170	Grommet Setting Dies	158
Face Mill Arbor BT MAS 403 / FMB	103	Half Dead Centre (Lathe Centre)	18
Face Mill Arbor SK-DIN 69871 SK / FMB	109	Hand Diamond Dressers	60
Face Mill Arbors	25	Hand Drill Pin Vice (Push Drill)	221
Face Mill Cutters - APKT Inserts	79	Hand Drill Pin Vise with Swivel Head (Master Pin Vice)	221
Face Mill Cutters APKT Inserts	271	Hand Knurling Holder	95
Feeler Gauge (Thickness Gauge)	149	Hand Rotary Pump (Barrel Type)	233
File Handles (Plastic)	7	Hand Taps (Carbon Steel & HSS)	248
File Handles (Wooden)	7	Hand Vice	173
Firm Joint (Odd Leg) Jenny Callipers	122	Hand Vice with Wing Nut	172
Firm Joint Callipers & Dividers	122	Hand Vice with Wing Nut	221
Fixed Vertical Slide	27	Handy Burr	245
Floating Tail Stock Die Holder Set	79	Heavy Duty Jack Screw Set	5
Fly Cutter	80	Hermaphrodite Callipers	125
Fly Cutter Tool Holder Taper Shank	79	High Low Adjustable Dressers	58
Fly Tool Cutter Holder	80	High Precision Live Centres for CNC Lathes (Multipoint)	15
Four Way Vee Blocks (V-Block Quadruple)	139	High Precision Live Centres for CNC Lathes (Extended Point)	14
G Clamp (Drop Forged) (C Clamp)	168	High Precision Live Centres for CNC Lathes (Low Body Extended Point)	15
G Clamp (Ductile) (C Clamp)	168	High Precision Live Centres for CNC Lathes (Low Body)	15
G Clamp (Sheeted / Welded / Pressed) (C Clamp)	169	High Precision Live Centres for CNC Lathes (Standard)	14
Gage Handle (Universal Pin Gage Handle)	70	Hinge Centering Punch	160
Gasket Punching Table	165	Hollow Punches (Belt Punches) (Leather Punch)	163
Graver Pin Vice	222	Hollow Wire Vice (Small Hand Vice)	222



INDEX

Alphabetical Order

	Page No.		Page No.
Horizontal & Vertical Two Direction Rapid Indexer	203	Knurling Tool Holders Multi Head	95
HSS Lathe Turning Tools Set of 6 Pcs.	237	Knurling Tool Holders Pivot Head (Two Knurl Wheels)	94
HSS Lathe Turning Tools Set of 8 Pcs.	238	Large Capacity Tap Wrench M4 to M20 Sturdy Tap Wrench	77
HSS Threading Tool Double Ended 2 Pcs. Set	237	Lathe Boring Tools	86
HSS Threading Tool Set of 2 Pcs	238	Lathe Carriers	6
Hydraulic Coupler (Pin Type)	227	Lathe Chuck - Self Centering	218
Hydraulic Couplers	227	Lathe Chuck Independent	218
Hydraulic Flexible Connectors (Z Type Couplers)	227	Lathe Chuck Keys	11
Hydraulic Machine Vice (Fixed Base) (Hydraulic Power)	187	Lathe Chuck Self Centering	217
Hydraulic Machine Vice (Heavy Duty) (Fixed & Swivel Base)	188	Lathe Turning Attachment	1
Hydraulic Machine Vice (Swivel Base) (Hydraulic Power)	187	Leather Punch (Hollow Punches) (Belt Punches)	163
Independent 4 Jaw Lathe Chuck (Dog Chuck)	10	Leg Vice	173
Indexable Boring Head	52	Letter and Number Set (Steel Stamp) (Letter & Number Punches)	164
Indexable Carbide Turning Tool Holder set of 5 Pcs	81	Letter & Number Punches (Set) (Letter & Number Sets) (Steel Stamps)	164
Indexable Carbide Turning Tool Holder Set of 5 Pcs.	239	Live Centre / Revolving Centre (Dual Bearing) (Economy Live Centres)	13
Indexable Carbide Turning Tool Holder set of 7 Pcs	82	Live Centre / Revolving Centre (Triple Bearing) (Heavy Duty)	13
Indexable Carbide Turning Tool Holder Set of 7 Pcs.	240	Long Drive Pin Punches (Drive Pin Punches 8 Inch)	156
Indexable End Mills APKT Inserts	87	Low Boy Angle Dressers	58
Indexable End Mills APKT Inserts	252	Machine Hand Tap Guide	7
Indexable End Mills ST & MT Shanks	87	Machine Reamers - HSS (Taper Shank)	262
Indexable End Mills ST & MT Shanks	251	Machine Vice 2 Way Tilting and Swivelling Angle	200
Indexable End Mills TPKN Inserts	87	Machine Vice 3 Way Tilting and Swivelling Angle	200
Indexable End Mills TPKN Inserts	251	Machinist Jack (Light Duty)	5
Indexing Milling Fixture (Horizontal & Vertical)	202	Machinist Scraper	127
Interchangeable Hollow Punch Set of 10 Pcs.	161	Machinist V-Block Set (Tool Maker's)	137
Interchangeable Reversible Tap Wrench Holder Set	72	Machinist Jacks (Heavy Duty)	5
Inverted Dovetail Cutters / Chamfer Cutter (Single Angle Shank Type Cutter)	269	Magic Vices	186
Involute Gear Cutter Set HSS B.S. 2518-1954	260	Magnet Cleaner	70
J & S Type Cut Off Holder (Cut off Tool Holder) (Parting Off Holder)	90	Magnetic Adjustable Links (Magnetic Welding Links)	63
J & S Type England Machine Vice - Fixed Base (Milling Machine Vice) (Precision)	199	Magnetic Back for Dial Indicator	68
J & S Type England Machine Vice - Swivel Base (Milling Machine Vice) (Precision)	199	Magnetic Base (High Power)	66
J & S Type, England Machine Vice Precision (Tilting & Swivelling Vice)	198	Magnetic Base (High Power) Flexible Arm	67
Knobs	9	Magnetic Base (Push Button) (Standard Magnetic Bases)	66
Knurling Tool - Quick Acting	98	Magnetic Base Holder	68
Knurling Tool Holder 3 Interchangeable Heads	96	Magnetic Base with Safety Shield	66
Knurling Tool Holder 6 knurls	95	Magnetic Chuck (Rectangular)	69
Knurling Tool Holder Adjustable Clamp Type	97	Magnetic Chuck (Round)	69
Knurling Tool Holder Adjustable Clamp Type	97	Magnetic Chuck Parallels and Universal V Blocks	67
Knurling Tool Holder Adjustable Clamp Type Spring Loaded	97	Magnetic Chuck Parallels and Universal V Blocks	134
Knurling Tool Holder Double Ended	94	Magnetic Clamp Set	65
Knurling Tool Holder Linear	96	Magnetic Clamps	65
Knurling Tool Holder Revolving Head 3 Knurl	95	Magnetic Ground Clamps	65
Knurling Tool Holder Single Ended	94	Magnetic Holder - With Clip	71
Knurling Tool Holder V clamp Type	96	Magnetic Pickup Tool (Telescopic Pick Up Magnet)	71
Knurling Tool Holders American Pattern - Two Wheels	94	Magnetic Quick Clamp Double	65
Knurling Tool Holders High Capacity Special	96	Magnetic Quick Clamp Multiangle (Magnetic Welders Clamp)	62
		Magnetic Separator	70
		Magnetic Squares (Magnetic Welding Square)	64



INDEX

Alphabetical Order

	Page No.		Page No.
Magnetic Swarf Wand	71	Modular Precision Milling Vice	195
Magnetic V Block Set	68	Morse Taper Adaptor BT MAS 403 / MTA	101
Magnetic V Block Set	135	Morse Taper Adapter (Taper Adapters)	26
Magnetic Welders Clamp	63	Morse Taper Adaptor SK-DIN 69871 / MTA	107
Magnetic Welders Clamp (Magnetic Quick Clamp Multiangle)	62	Morse Taper Arbors	24
Magnetic Welding Links	64	Morse Taper Finishing / Roughing Reamer (Socket Reamer) (Morse Taper Reamer)	268
Magnetic Welding Links (Magnetic Adjustable Links)	63	Morse Taper Reamer (Socket Reamer) (Morse Taper Finishing / Roughing Reamer)	268
Magnetic Welding Square (Magnetic Square)	64	Multipoint Live Centre (Precision)	14
Marking Gauge	151	Multipurpose Angle Protractor	147
Marking Knife Scriber	128	Multipurpose Bench Vice	177
Marking Punch - Heavy Duty (Automatic Centre Punches)	154	Nail Punches (Square and Round Head)	164
Master Pin Vice (Hand Drill Pin Vise with Swivel Head)	221	O Ring Hook & Scriber - 2 Pcs Set	129
Micro Boring Head	54	Off Center Bench Vise	180
Micro Chuck - Micro Pin Chuck	223	Offset Steel Bench Vise	179
Micro Sensitive Drill Adaptor	4	Oil Can - Snap Type	232
Micrometer Stand Base (Standard)	126	Oil Cans (Perfecto Type) (Perfecto Type Oiler)	231
Milling and Drilling Table (Compound Sliding Table)	200	Oil Cans (Pint Type) (Pint Type Oiler)	231
Milling Machine Vice (Fixed Base)	198	Oil Cans (Pistol Type)	231
Milling Machine Vice (Swivel Base)	198	Oil Gun	233
Milling Machine Vice (Fixed Base) (J & S Type, England Type) (Precision)	199	Oil Hole Cover (Drive Fit)	225
Milling Machine Vice (Swivel Base) (J & S Type, England Type) (Precision)	199	Oil Level Indicators	224
Mini Tap Handle	75	Oil Windows	224
Mini Bending Brake Aluminium	219	Open End Sleeve with Extractor - DIN 228	24
Mini Boring Heads	50	Optical Center Punch Set	165
Mini Brass Drill Pin Vice	221	Parallel Clamps (Toolmaker's)	170
Mini Lathe Chuck With Shanks	11	Parallel Hand Reamers - HSS	263
Mini Lathe Live Revolving Centre for Peatol & Pultra Lathes	18	Parallel Pin Punches Long Reach	158
Mini Magnetic Stand - Mini Magnetic Base	61	Parallel Pin Punches Short Reach	157
Mini Magnetic Stand - Mini Magnetic Base	61	Parallel Shank End Mill Cutters	256
Mini Parting Holder	90	Parting & Groove Holders	89
Mini Parting Holder Clamp Type	89	Parting Off Holder (J & S Type Cut Off Holder) (Cut Off Tool Holder)	90
Mini Quick Change Tool Post Holder Set Aluminium	30	Parting Tool Holder	91
Mini Revolving Center Live Center / Revolving Center (Mini)	18	Parting Tool Holder Eclipse Type	90
Mini Rolling and Bending Machine	219	Parting Tool Holder Screw Clamping	91
Mini Tailstock Tilting	216	Parting Tool Holder Komet Type	92
Mini Turning Tool Holder	89	Parting Tool Holder (Cut off Tool Blocks) (Quick Clamp Parting Tool Holder)	90
Mini Universal Metal Bender	219	Parting Tool Holder for Blades	91
Mini Vertical Slide	27	Parting Tool Holders	35
Mini Vertical Slide	28	Pick Up Tools	222
Mini Vice - For Rotary Table or Vertical slide	28	Piloted Spindle Tap Wrench	73
Mini Vice Brass Jaws	223	Pin Chuck Set	222
Mini Vice For Rotary Table or Vertical Slide	213	Pin Tong	223
Miniature Double End Mills (3/16" Shank)	254	Pin Vice Sliding	222
Miniature Quill With JTO Drill Chuck	4	Pin Vice Wooden Handle	223
Model Railroad Ruler	130	Pipe Vice (Pillar Type, Changeable Jaws)	176
Modular Machine Vice Cum Slotted Table	140	Pipe Vice (Unbreakable, SG Iron Body) (Open Type Replaceable Jaws)	176
Modular Machine Vice Cum Slotted Table	203	Pipe Vice (Open Type)	176
Modular Precision Machine Vice with Parallel Top Jaws	192		



INDEX

Alphabetical Order

	Page No.		Page No.
Pipe Vice (Round Pillar)	176	Precision Self Centering Vice 5 Axis	194
Pipe Vice (Self Locking)	175	Precision Sine Vice (Lead Screw Type)	185
Pipe Vice Open Type Replaceable Jaws (Pipe Vice unbreakable - SG Iron)	176	Precision Sine Vice (Screwless Type - Pin Type)	185
Pipe Vice Stand (Self Locking Pipe Vice)	175	Precision Steel Squares Engineers	120
Plate Bench Shear	220	Precision Steel Squares Flat & Back Base	121
Plate Bench Shear Spring Type	220	Precision Steel Squares Sets (4 Pcs.)	145
Pocket Scraper	128	Precision Tilt Lock Down Machine Vice (Kurt Type-Fixed Base-Rear Jaws)	192
Pocket Scraper - Eclipse Type	129	Precision Tool Makers Vice	184
Pocket Magnet	71	Precision Tool Room Bench Vice German Type (Bench Vice)	179
Pocket Magnets - U Magnets - Horse Shoe Magnets	60	Precision Tools Set (11 Pcs.)	145
Polygon Machine Vice	186	Precision V-Block & Clamp (Ultimate) (All Angle)	138
Portable Hand Shear	220	Precision V-Block & Clamp Set (Multi Side Use) (V Block Stepped Groove)	138
Pot Magnets	62	Press Button Oiler (Drive Fit)	225
Power Magnets with T Handle	61	Prick Punches (Heavy)	161
Precision 3 Way Drill Vice Uni-Grip	181	Prick Punches (Light)	160
Precision 3 Way Universal Drill Press Vises	180	Profile Depth Gauge Brass (Brass Tyre Profile Depth Gauge)	153
Precision Adjustable Angle Block Sets	138	Protractor (Degree Protractors)	147
Precision Boring Head Kit 30 mm	49	Protractor Cum Depth Gauge	147
Precision Boring Head Kit 30 mm - MT Shank	48	Protractor Degree Protractor Half Moon	151
Precision Boring Head Kit 30 mm - MT Shank + Straight Shank	47	Pull Studs BT MAS 403	113
Precision Boring Head Kit 30 mm - Straight Shank	48	Pull Studs DIN 69872	114
Precision Boring Head Kit 38 mm - MT + Straight Shank	43	Pull Studs ISO 7388 B	114
Precision Boring Head Kit 38 mm - MT Shank	44	Punch & Chisel Holder	167
Precision Boring Head Kit 38 mm - Straight Shank	45	Quick Acting Vises	181
Precision Boring Head Kit 38 mm - Straight Shank	46	Quick Change Chuck Adapter	27
Precision Boring Head Kit 50 mm / 2"	43	Quick Change Chuck Adapter	116
Precision Boring Head Kit 50 mm / 2" - BT Shank	39	Quick Change Precision Vice	181
Precision Boring Head Kit 50 mm / 2" - ISO Shank	40	Quick Change Tool Post	34
Precision Boring Head Kit 50 mm / 2" - MT Shank	41	Quick Change Tool Post C2 & C3 Lathes	33
Precision Boring Head Kit 50 mm / 2" - R8 Shank	42	Quick Change Tool Post Compatible to Mount on MYFORD & Mini Lathes	30
Precision Boring Head Kit 62 mm	39	Quick Change Tool Post Dixon Type	33
Precision Boring Head Kit 75 mm / 3" BT Shank	36	Quick Change Tool Post Dual mounting	33
Precision Boring Head Kit 75 mm / 3" ISO Shank	37	Quick Change Tool Post Economy Starter Set	35
Precision Boring Head Kit 75 mm / 3" - MT Shank	37	Quick Change Tool Post Set Multifix - 40 Position	32
Precision Boring Head Kit 75 mm / 3" - R8 Shank	38	Quick Change Tool Post Single Mounting	34
Precision Boring Heads	51	Quick Change Tool Post T2 Size	34
Precision Grinding Control Vice	186	Quick Change Tool Post T72 / T2	34
Precision Grinding Vice	185	Quick Change Tool Post Wedge Type	31
Precision Grinding Vice (Tool Maker's Precision Steel Vice)	185	Quick Clamp Parting Tool Holder (Cut Off Tool Blocks) (Parting Tool Holder)	90
Precision High Grip Machine Vice	194	Quick Release Callipers German Type (Square Leg Spring Divider) (Precision)	124
Precision High Grip Machine Vice (Self Centering)	194	Quick Release Steel Vice	180
Precision High Grip Shaft Vice (Self Centering)	193	Quill Feed Handle	9
Precision Machine Vice (Swivel Base)	196	Quill Stop	9
Precision Machine Vice Fixed Base - Heavy Duty	196	R 8 Drill Chuck Arbors	24
Precision Machine Vice Swivel Base - Heavy Duty	196	R-8 Fly Cutter Holder	80
Precision Mini Tilt & Swivel Base Vice	187		
Precision Multigrip Machine Vice Serrated Slideways	193		
Precision Quick Setting Machine Vice	191		



INDEX

Alphabetical Order

	Page No.		Page No.
R-8 Saw Holder	92	Round Vice For Rotary Table or Vertical Slide	213
Radius Gauge (Locking Type)	149	Safety Self Ejecting Lathe chuck keys	11
Radius Gauge - Weld Gauge	149	Saw & Gear Cutter Holder	93
Radius Gauge (Ring Type)	149	Saw Holder (Saw Holder Circular) (Slitting Saw Holder Straight Shank)	92
Radius Shank Type Cutters (Concave & Convex)	272	Saw Holder Circular (Slitting Saw Holder Straight Shank) (Saw Holder)	92
Radius Turning Attachment Ball and Radius Turning Tool	1	Saw Holder Mini	93
Reduction Sleeves (Drill Sleeves)	23	Saw Holder Taper Shank & MT Shank	93
Repairman's Taper Reamer	261	Screw Extractor	57
Reversible Tapping Attachment	5	Screw Cutting Gauge	151
Revolving Center / Live Center With Chuck	17	Screw Pitch Gauge	150
Revolving Punch Plier	161	Screw Pitch Gauge (Triangular)	150
Revolving Tailstock Arbor	17	Screw-In Spare Tangs	27
Revolving Tailstock Chuck Adaptor for Boxford & Myford Lathe Machine	17	Self Aligning Tap and Reamer Holder (Tap and Reamer Aligner / Holder)	76
Right Angle Iron Plate	142	Self Centering Corner Vice	169
Rocking Tool Posts	36	Self Centering lathe Chuck (True Chuck) (3 Jaws)	10
Rolling Pin Punch Set	158	Self Centering Shaft Vice (Crank Shaft Vice)	177
Rotary Head Vice (Swivel Base)	187	Self Centering Vice (Fixed Base)	197
Rotary Milling Table (Rotary Milling Table Horizontal & Vertical System)	208	Self Centering Vice (Swivel Base)	197
Rotary Table Horizontal & Vertical - 3" / 75 mm	204	Self Centring Vice Precision	197
Rotary Table Horizontal & Vertical - 4-3/8" / 110 mm	206	Self Locking Pipe Vice (Pipe Vice Stand)	175
Rotary Table Horizontal & Vertical - 5" / 125 mm	206	Sensitive Drill Attachment	4
Rotary Table Tilting - 3" / 75 mm	204	Shallow Ceramic Magnets	64
Rotary Table Tilting MT2 - 4" / 100 mm	205	Shank Types	99
Rotary Table Horizontal & Vertical - 6" / 150 mm	207	Shanks for Boring Heads	56
Rotary Table Horizontal & Vertical - 8" / 200 mm	207	Shanks for Mini Boring Heads	50
Rotary Table Tilting - 4" / 100 mm	205	Shaper Vice (Fixed Base)	201
Rotary Table 3" Set (With 3 or 4 Jaws Chuck)	209	Shaper Vice (Swivel Base)	201
Rotary Table 3" Tilting Set	209	Shell End Mill Arbor BT MAS 403 / SMS	105
Rotary Table 4" Set (With 3 or 4 Jaws Chuck)	210	Shell End Mill Arbor SK-DIN 69871 SK / SMS	111
Rotary Table 4" Set (with Tailstock, Clamping Kit & Chuck)	209	Short Drive Pin Punches (Drive Pin Punch - 4 Inch Long)	155
Rotary Table 4" Tilting Set	210	Shoulder Mill Arbor SK-DIN 69871 SK / FMC	110
Rotary Table 5" Set	210	Sine Bar Economy	132
Rotary Table For Watchmaker's, Jewellery, Milling - 2-3/8"	204	Sine Bar Precision	133
Rotary Table Horizontal & Vertical - 4" / 100 mm	205	Single Angle Dovetail Cutter (Dovetail Milling Cutter) (Single Angle Shank Type Cutter)	270
Rotary Table Set For Watchmaker's, Jewellery, Milling 2-3/4" / 68mm	208	Single Angle Shank Type Cutter (Chamfer Cutter) (Inverted Dovetail Cutters / Chamfer Cutter)	269
Rotary Table Set HV4	211	Single Angle Shank Type Cutter (Dovetail Milling Cutter) (Single Angle Dovetail Cutter)	270
Rotary Table Set HV4 (4-3/8" / 110 mm)	211	Single Ended Pin Vices	222
Rotary Table Set HV6 - Rotary Table, Tailstock & Indexing Plates Set	212	Single Flute Countersinks - HSS	243
Rotary Table Set HV6 With Chuck	212	Single Point Diamond Dresser	58
Rotary Table Square Base 2 Slot - 98 mm	204	Single Point Scriber	128
Rotary Table Tilting - 4-3/8" / 110 mm	206	Six Flute Countersinks	244
Rotary Table Tilting - 6" / 150 mm	207	Sliding Gauge Brass (Brass Vernier Callipers)	126
Round Bar Centre Finder	130	Sliding Gauge Brass Round Jaws (Brass Vernier Callipers)	126
Round Die Stock Handle (Die Holder / Handle - MS)	72		
Round Dies (Carbon Steel & HSS Quality)	249		
Round Tool Holders Double Ended	88		
Round Vice For Rotary Table or Vertical Slide	29		



INDEX

Alphabetical Order

	Page No.		Page No.
Sliding T Bevel Aluminium	119	T Bar Cramps (T Bar Clamps)	169
Slim Angle Plate	140	T Handle Tap Wrenches Standard Type (T. Tap Wrenches / Handle) (Solid Jaws)	73
Slitting Saw Holder Straight Shank (Saw Holder) (Saw Holder Circular)	92	T NUTS For Rotary Table	214
Slot Milling Cutters Parallel Shank	259	T Slot Cleaner	5
Slotted Machine Angle Plate (Webbed and Open)	142	T Slot Cutters (Taper Shank and Parallel Shank)	271
Slow Speed Revolving Center - Live Center	17	T. Tap Wrenches / Handle Ratchet Type	72
Small Angle Plate for Myford Lathes	140	T. Tap Wrenches / Handle Replaceable Jaws	73
Small Hand Vice (Hollow Wire Vice)	222	T. Tap Wrenches / Handle (Solid Jaws) (T Handle Tap Wrenches) (Standard Type)	73
Small Milling Vice For Myford Lathe	29	Table Vice - Fixed Base (Baby Vice) (Baby Bench Vice)	174
Small Milling Vice Myford Lathe	213	Table Vice - Swivel Base (Baby Vice) (Baby Bench Vice)	174
Socket Reamers (Morse Taper Finishing / Roughing Reamer) (Morse Taper Reamer)	268	Tail Stock Die Holder Set	78
Solid Sockets (Turret Sockets)	22	Tail Stock Die Holder Set	78
Solid Angle Plate	142	Tail Stock Quick Change Turret Head with 3 Station	16
Solid Cap Screw Counter Bore	242	Tail Stock Quick Change Turret Head with 4 Station	16
Solid Collet Stop Adjustable	8	Tap Extensions	75
Spare Knurls	98	Tap & Round Die Sets - Complete	250
Spring Callipers & Dividers Flat Leg	124	Tap and Reamer Aligner / Holder (Self Aligning Tap and Reamer Holder)	76
Spring Callipers & Dividers Premium quality	122	Tap Guide (Knurled Body)	7
Spring Divider Interchangeable Points	125	Tap Guide (Spring Centre)	7
Spring Lid Oil Cups and Elbow Oiler	225	Taper & Parallel Test Bars / Mandrels	20
Spring Lid Small Oiler	225	Taper Adapters (Morse Taper Adapter)	26
Square Chuck Pin Vice	221	Taper Pin Reamers ANSI B94.2	267
Square Leg Pencil Holder - Heavy Duty (Wing Compass - German Type)	124	Taper Pipe Reamers ANSI B94.2	268
Square Leg Spring Divider Precision (Quick Release Callipers German Type)	124	Taper Punches (Aligning Punches)	160
Standard Holders Turning Tool Holders	35	Taper Shank Arbors (Drill Chuck Arbors)	21
Standard Magnetic Bases (Magnetic Base Push Button)	66	Taper Turning Attachment	12
Starting Punches (Heavy Duty)	161	Taper Turning Attachment With Dead Center for Lathe Machine	12
Steel Parallels	134	Taper Turning Attachment With Revolving Center for Lathe Machine	12
Steel Rules	129	Telescopic Pick up Magnet (Magnetic Pickup Tool)	71
Steel Stamps (Letter & Number Punches / Sets)	164	Thickness Gauge (Feeler Gauge)	149
Stepped Angle Plate	141	Threaded Arbors (Drill Chuck Arbors Threaded)	22
Straight Stub Milling Arbor	25	Three Flute Countersinks - HSS	244
Straight Shank Arbors (Drill Chuck Arbor)	20	Three Point Scriber	128
Straight Stub MT Arbor	22	Tilt Lock Down Machine Vice (Kurt Type - Fixed Base - Precision)	189
Stub Milling Arbor for Gear Cutting	93	Tilt Lock Down Self Centering Vice (Angle Lock Self Centering Vice)	190
Suction Guns / Suction Pumps (Style 1)	232	Tilt Lock Hydraulic Vice (Precision)	190
Suction Guns / Suction Pumps (Style 2)	232	Tilt Lock Machine Vice (Fixed Base) (Kurt Type)	189
Suction Guns / Suction Pumps (Style 3)	232	Tilt Lock Machine Vice (Swivel Base) (Kurt Type)	188
Suction Guns / Suction Pumps (Style 4)	232	Tilting & Swivelling Vice (J & S Type, England Type) (Precision)	198
Suction Guns / Suction Pumps (Style 5)	232	Tilting Indexing Device	203
Surface Gauge Tool Makers (Surface Marking Block / Gauges)	152	Tilting Jaw Drill Press Vises	181
Surface Marking Block / Gauge (Surface Gauge Tool Makers)	152	Tilting Tables (Adjustable Angle Plate)	143
Surface Marking Blocks / Gauges Round Base	153	Tire Tread Feeler Gauge Double Point Brass	153
Surface Plate (Cast Iron & Graphite)	143	Tire Tread Feeler Gauge Single Point Brass	153
Surface Plate Box Type (Cast Iron)	144	Tool Bits (Square, Round and Rectangular Tool Bits)	247
Swivel Angle Plates / Table	141	Tool Holders for Drill Chucks DIN 69871A	112
T Bar Clamps (T Bar Cramps)	169	Tool Holders for Drill Chucks MAS 403 BT	112



INDEX

Alphabetical Order

	Page No.		Page No.
Tool Maker's Precision Steel Vice (Precision Grinding Vice)	185	Valve Seat & Face Cutter Sets Professional 45 Degree	274
Toolmaker's Precision Screwless Vice	184	VEE Adaptor - For Round Bar	12
Toolmakers Parallel Clamp	170	Vee Angle Blocks & Angle Plate Combined	140
Trammel Point Set	121	Vee Blocks - Non Protruding	136
Trammel Set - 2 Pcs.	122	Vernier Callipers	127
Transfer Punches	166	Vernier Height Gauge	151
Transfer Pump (Transfer Gun)	233	Versatile Vee Block with Clamps (Ultra Precision Vee Block)	139
Triangular Scraper	128	Vertical Milling Attachment Slide Swivel Base	28
Triangular Pin Vise	221	Vertical Milling Slides Suitable for ML7 Lathes	28
Triple Vee Blocks	136	Vertical Sliding Table	29
True Chuck	10	Vice For Rotary Table or Vertical Slide	213
T-Tap Wrench - Cam Lock	76	Vice For Vertical Table or Vertical Slide	30
Turning Tool Bit Holder Adjustable	88	Wad Punch Kit	165
Turning Tool Bit Holder American Pattern	88	Wad Punch Kit	165
Turning Tool Bit Holder British / English Pattern	88	Wavy Parallels (Set of 8 Pcs.)	133
Turret Sockets (Solid Sockets)	21	Wedge Clamps (Used in Precision Multigrip Machine Vice Serrated Slide Ways)	193
Twist Drill Grinding Gauge	147	Welding Taper Bore Gauge & Steel Ruler	130
Twist Drill Grinding Gauges	152	Welding Taper Bore Gauge and Steel Ruler	148
Two Fixed Point Scriber	129	Wheel Dressers Emry Wheel Dressers & Cutters (Huntington Type)	60
Two Piece Modular Precision Milling Vice	195	Wigglers Centre Finders	130
Two Point Scriber	128	Wing Compass	123
Ultimate V Block & Clamp (All Angle) (Precision)	138	Wing Compass (German Type , Square Leg)	123
Ultra Precision Vee Block (Versatile Vee Block with Clamps)	139	Wing Compass (German Type , Square Leg) (Square Leg Pencil Holders - Heavy Duty)	124
Unigrip Machine Vice (Heavy Duty - Precision)	197	Wing Compass With & Without Pencil Holder	125
Universal Circle Cutter	3	Wire Gauge / Wire Gage (Round and Rectangular)	148
Universal Clamps	67	Wood Workers Vice - Quick Release (Woodworking Vice)	172
Universal Compound Vice	183	Wood Workers Vice (Woodworking Vice)	172
Universal Dividing Head (Complete With Gear Head)	202	Wooden File Handle with Brass Collet	223
Universal Dividing Head	201	Woodruff Cutter (Woodruff Key Slot Cutter and Woodruff Key Seat Cutter)	272
Universal Grinding Gauges	152	Woodruff Key Slot Cutter and Woodruff Key Seat Cutter (Woodruff Cutter)	272
Universal Machine Vice (Universal Vice)	199	Woodworking Callipers	123
Universal Magnetic Indicator Holder	63	Woodworking Callipers Brass Wing Nut	123
Universal Mighty Magnetic Base	70	Woodworking Lathe Spindle Adapter	2
Universal Pin Gage Handle	70	Woodworking Lathe Spindle Adaptor	1
Universal Tilting Tables (Adjustable Angle Plate) (Precision)	141	Woodworking Vice (Wood Workers Vice)	172
Universal Tool Holder (3 Way Tool Holder)	89	Woodworking Vice (Wood Workers Vice) (Quick Release)	172
Universal Transfer Punch & Aligner	166	Woodworking Vice Record Type	172
Universal Vice (Universal Machine Vice)	199	Work Stop	9
Utility Punch & Scriber	166	Working Block Pairs	133
V - Block (Casted)	137	Z Type Couplers (Hydraulic Flexible Connectors)	227
V - Block Quadruple (Four Way Vee Blocks)	139	Zero Point Setter	126
V Block Jig Fixture (For Center Drilling of Round Work)	136		
V Block Stepped Groove (Multisided Use) (Precision V-Block & Clamp Set)	138		
V Sine Bar	133		
Valve Seat & Face Cutter Sets	2		
Valve Seat & Face Cutter Sets	274		
Valve Seat & Face Cutter Sets Professional 45 Degree	2		

Radius Turning Attachment



BALL AND RADIUS TURNING TOOL, LARGE, OMW & OTHER LATHES

- Balls in the ends of rods, shafts, or handles are easily turned with the tool. You can also make ball joints, governor weights, railing knobs, round contact points for tools, nose cones, and many other useful and decorative objects. With V-Groove across face to accommodate round stock.
- Cuts ball-shaped objects or turns a radius on the end of a work piece.
- Swing the handle to rotate the cutter.
- Turn up to 3/4" (20mm) diameter.
- High Speed Steel cutter included.

Item Code No.	Shank	Description
ABM-IMT-7941	3/8" (10 mm)	Complete with Cutter
ABM-IMT-7942	1/2" (12 mm)	Complete with Cutter
ABM-IMT-7943		Spare Cutter

Ball Turning Attachment



Item Code No.
ABM-IMT-6080

- For Lathes Center Height 3-1/2".
- Max. ball diameter possible 38 mm.
- Head is adjustable for different Ball sizes.
- Comes with one Indexable TNMG 16 Insert for best turning and results.
- It fits straight onto the cross slide of your lathe machine for Quick Turning of Cones & Balls.

Lathe Turning Attachment

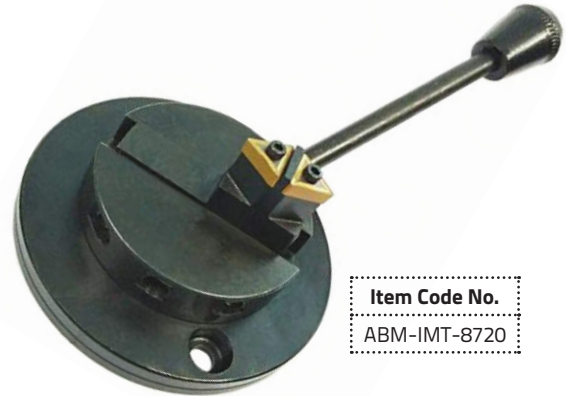

Item Code No.
ABM-IMT-8720

URNS ROUND CONCAVE AND CONVEX METAL-WOOD BALL QUICKLY DIY TOOL-SUITS MYFORD & SIMILAR LATHES

- Center Height is 52 – 52.5 mm which is pre-designed and prefixed for Myford Lathe Machines.
- However Can fit to Larger Machines by using Packing to Adjust Center Height
- Can turn up-to a 50 mm diameter Metal or Wood Ball.
- Can be Adjusted for Various Sizes of Balls.
- Supplied with 2 Pcs x 3 Sided Indexable TNMG16 Tips Design For Internal & External Turning

Woodworking Lathe Spindle Adaptor



FOR MOUNTING POLISHING & BUFFING WHEELS

- Lathe Spindle Adapter available to fit 5/8" plain spindle.
- Spindle adapter is bored in 5/8" for the plain Shopsmith spindle and has a locking set screw.
- Other end is threaded with 2 washers and a nut to tighten any buffing polishing wheel or any other similar accessory.
- Drilling Buffing Polishing Shaping on a Shop-smith Wood working lathe.
- It is very important that you securely fasten the spindle adapter to your lathe spindle, and any of your 1-8 threaded accessories to the spindle adapter. Failure to properly secure these components can result in injury.

Item Code No.	Internal Bore Size
ABM-IMT-8710	5/8" Plain Bore Inside
ABM-IMT-8711	1/2" Plain Bore Inside



Valve Seat & Face Cutter Sets

Professional 45 Degree



Available in Carbon Steel, HSS & Carbide

- Manufactured from high grade carbon steel, properly hardened & tempered.
- The cutting edge of all the cutters are accurately ground for best results.
- Sets supplied in fine finished wooden box.
- Suitable for re-cutting inlet/exhaust valve seats concentric to the valve guides.
- Features cutting blades, expandable pilots and double end cutters for increased application.

Item Code No.	No of Pcs in Each Set	Sizes of Valve Seat & Face Cutter Included Inches
ABM-IMT-8441	5 Pcs Set	CUTTERS : 42.5, 40, 37.5, 35 & 32.5 mm THREADED SPINDLE : 6.5, 7, 7.5, 8, 8.5 mm TOMMY BAR : M8
ABM-IMT-8442	13 Pcs Set	CUTTERS : 30, 32, 37.5, 40, 42.5, 45, 47.5, 50, 52.5, 55, 57.5 & mm THREADED SPINDLE : 6, 6.5, 7, 7.5, 8, 8.5, 9, 9.5, 10, 10.5, 11, 11.5 & 12 mm TOMMY BAR : M8

Woodworking Lathe Spindle Adapter



Item Code No.
ABM-IMT-8700

- Fits on 5/8" plain Shopsmith spindle
- Bored 5/8" for the plain Shopsmith spindle and has a locking set screw.
- The other end is threaded with a cap to tighten any buffing polishing wheel or any other similar accessory
- Drilling Buffing Polishing Shaping on a Shop-smith Wood working lathe
- It is very important that you securely fasten the spindle adapter to your lathe spindle.
- Failure to properly secure these components can result in injury.

Valve Seat & Face Cutter Sets

- Manufactured from high grade carbon steel, properly hardened & tempered.
- The cutting edge of all the cutters are accurately ground for best results.
- Sets supplied in fine finished wooden box.
- Suitable for re-cutting inlet/exhaust valve seats concentric to the valve guides.
- Features cutting blades, expandable pilots and double end cutters for increased application.



Available in Carbon Steel, HSS & Carbide

Item Code No.	No of Pcs in Each Set	Sizes of Valve Seat & Face Cutter Included Inches
ABM-IMT-8431	3 Pcs Set	1-5/16 & 1-7/16 (45°) (Supplied with 2 Nos. Guides, 1 Nos. Each Handle, Rod & Small Pin) Size of Bore Cutters Included 1-3/8" (20°)
ABM-IMT-8432	4 Pcs Set	1-5/16, 1-7/16 & 1-3/8 (45°) (Supplied with 2 Nos. Guides, 1 Nos. Each Handle, Rod & Small Pin) Size of Bore Cutters Included 1-3/8" (20°)
ABM-IMT-8433	10 Pcs Set	1-3/16, 1-1/4, 1-5/16, 1-3/8, 1-1/2, 1-11/16, 1-1/4 & 1-9/16 (20°), 1-3/4 (45°) & 1-11/16 (30°) (Supplied with 8 Nos. Guides, 2 Nos. Each Handle, 2 Rods & Small Pin) Size of Bore Cutters Included 1-1/4" & 1-9/16" (20°)
ABM-IMT-8434	12 Pcs Set	1-3/16, 1-1/4, 1-5/16, 1-3/8, 1-1/2, 1-11/16, 1-1/4 & 1-9/16 (20°), 1-3/4 (45°), 1-11/16 (30°) & 2-1/16 (45°) (Supplied with 8 Nos. Guides, 2 Nos. Each Handle, 2 Rods & Small Pin) Size of Bore Cutters Included 1-1/4", 1-9/16" (20°) & 1-3/4 (45°)
ABM-IMT-8435	15 Pcs Set	1-3/16, 1-1/4, 1-5/16, 1-3/8, 1-1/2, 1-11/16, 1-1/4 & 1-9/16 (20°), 1-3/4 (45°), 1-11/16 (30°) & 2-1/16, 1-7/16, 1-5/8 & 2-1/8 (45°) (Supplied with 8 Nos. Guides, 2 Nos. Each Handle, 2 Rods & Small Pin) Size of Bore Cutters Included 1-1/4", 1-9/16" (20°) & 1-3/4 (45°)
ABM-IMT-8436	20 Pcs Set	1-3/16, 1-1/4, 1-5/16, 1-3/8, 1-1/2, 1-11/16, 1-1/4 & 1-9/16 (20°), 1-3/4 (45°), 1-11/16 (30°) & 2-1/16, 1-7/16, 1-5/8, 2-1/8, 1-1/8, 1-7/8 & 2-1/4 (45°) (Supplied with 8 Nos. Guides, 2 Nos. Each Handle, 2 Rods & Small Pin) Size of Bore Cutters Included 1-1/4", 1-9/16" (20°), 1-3/4 & 2"(45°)

Bench Block



- With V-Groove across face to accommodate round stock.
- Hardened and ground.

Item Code No.	Block Dia.		Block Height		Block Holes	
	Inch	mm	Inch	mm	Inch	mm
ABM-IMT-3500	3	75	1-1/2	38	1/8 to 5/8	3 to 15

Drill Chuck Keys

- Made from Alloy steel.
- Hardened and black shiny finish.
- Available in different sizes.
- Available as per customer's specifications.



Item Code No.	Size Inch
ABM-IMT-3501	1/4"
ABM-IMT-3502	3/8"
ABM-IMT-3503	1/2"
ABM-IMT-3504	5/8"
ABM-IMT-3505	3/4"
ABM-IMT-3506	1"

Universal Circle Cutter

- Handy Tool that enables drilling of small holes with high precision.
- Drill can be moved easily and Precisely with Lever Mechanism.
- Allows approx 25 mm (1") of Travel
- To be used with drill chuck either Key Type or Keyless.

Item Code No.	Shank	Capacity
ABM-IMT-7930	12 mm	40 - 165 mm
ABM-IMT-7931	Spare Cutter Size 1/4" x 2" (5% Cobalt)	

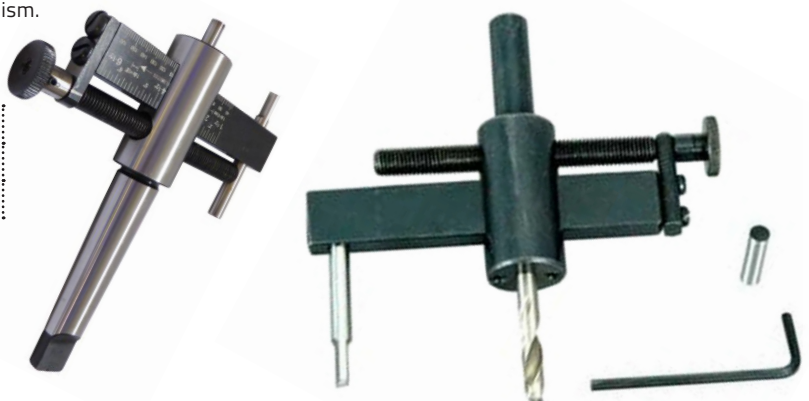

Drill Chucks (With Key)



- Key Operated Guided Jaws Type.
- Made From Special Steel.
- Screw Rings Hardened and Ground.
- Key Hardened and Blacked.
- Spare Keys Available.

Item Code No.	Chuck Capacity	Chuck Mount
ABM-IMT-3507	0 - 6.5	1 JT
ABM-IMT-3508	0 - 6.5	2.8 - 24
ABM-IMT-3509	1.5 - 10	3.8 - 24
ABM-IMT-3510	1.5 - 10	1.2 - 20
ABM-IMT-3511	1.5 - 10	2 JT
ABM-IMT-3512	1.5 - 10	1.1 - 20
ABM-IMT-3513	1.5 - 13	1.2 - 20
ABM-IMT-3514	1.5 - 13	5.8 - 16
ABM-IMT-3515	0 - 13	6 JT
ABM-IMT-3516	3 - 16	1.2 - 20
ABM-IMT-3517	3 - 16	2 JT
ABM-IMT-3518	3 - 16	4.8 - 16
ABM-IMT-3519	5 - 20	3 JT
ABM-IMT-3520	5 - 20	5.8 - 16
ABM-IMT-3521	5 - 20	3.4 - 16
ABM-IMT-3519S	5 - 25	3 JT
ABM-IMT-3520S	5 - 25	5.8 - 16
ABM-IMT-3521S	5 - 25	3.4 - 16



Drill Chucks (Keyless)



- Hardened Jaws.
- Available in 1/4" and 1/2" Capacity.

Knurled Knobs Item Code No.	Capacity	Thread Size
ABM-IMT-3690	1/4"	1/2" x 20
ABM-IMT-3691	1/2"	1/2" x 20
ABM-IMT-3692	1/4"	3/8" x 24

Sensitive Drill Attachment



- The manual control on the drilling force helps reducing the break age in fine holes with high accuracy.
- Can fit to any lathe's tailstock and is available in 2 & 3 Morse Taper.
- The Front mounting can be provided by us with Taper or Thread for chuck mounting as required by any customer depending on his market needs.
- Shank is precisely ground.
- A Very Handy Tool that enables drilling of Small holes with High Precision
- Drill Can be Moved Easily and Precisely with Lever Mechanism
- Allows approx 25mm (1") of Travel
- To be used with Drill Chuck either Keyless or Key Type

Item Code No.	Size
ABM-IMT-7910	MT2 x B16
ABM-IMT-7911	MT2 x B18
ABM-IMT-7912	MT2 x B22
ABM-IMT-7913	MT3 x B16
ABM-IMT-7914	MT3 x B18
ABM-IMT-7915	MT3 x B22
ABM-IMT-7916	MT2 x JT2
ABM-IMT-7917	MT2 x JT3
ABM-IMT-7918	MT2 x JT33
ABM-IMT-7919	MT3 x JT2
ABM-IMT-7920	MT3 x JT3
ABM-IMT-7921	MT3 x JT33

Drill Drift

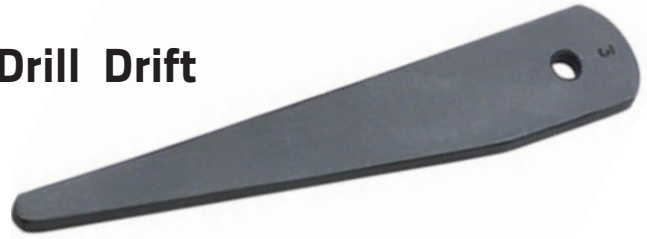

- Drill Drift also known as wedge shaped drift ,used to remove/loose chuck, sleeve, socket, from a receiving member.
- Firstly, The flat tapered key with one round edge , designed to fit into spindle chuck's slot. Secondly ,Then the tapered shank drill forced to loose. In conclusion Morse tapered key ,used to remove tapered shank tools by inserting the keys into the chucks slot , Then struck with a soft hammer to jar the taper shank tools loose.
- These are blackened with permanent marking of size for easy identification .
- Fully Hardened and Black Finish.
- Also Available as per DIN Standards.

Item Code No.	Drift No.	Fits No. Socket & Sleeves
ABM-IMT-3760	1	1
ABM-IMT-3761	2	2
ABM-IMT-3762	3	3
ABM-IMT-3763	4	4 - 5 - 6
ABM-IMT-3764	3 Pcs Set consistig of # 1, 2, 3	
ABM-IMT-3765	4 Pcs Set consistig of # 1, 2, 3, 4	

Drill Chucks (With Key)

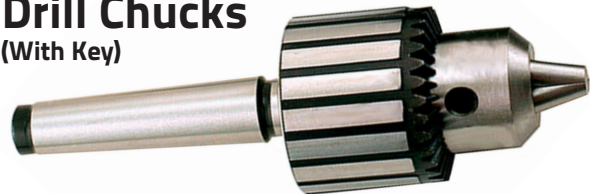

- 1/2" Drill Chuck with MT2-JT6 Drill Chuck Arbor.
- With Drill Chuck Key for adjustments.

Item Code No.	Capacity
ABM-IMT-25201	1/2"

Micro Sensitive Drill Adaptor Miniature Quill With JTO Drill Chuck



- Quality Tool Steel's Micro Drill Adaptor (Sensitive drill adaptor) or can be called a miniature quill & is designed to drill small holes using a lathe, mill or pillar drill.
- Sensitive Finger Control.
- Controls manual feed pressure very easily, which helps in preventing Drill breakage.
- Very well suited for making small holes with large machines.
- Shank is 1/2" Straight.
- Comes with a small capacity of 0.3 to 4 mm JTO Drill chuck.



Reversible Tapping Attachment

- A versatile attachment suitable use to drilling machines for drilling thru blind holes with standard taps.
- The automatic reverse mechanism has a double back out speed and an adjustable friction clutch to avoid tap breakage.

Item Code No.	MT	CAPACITY
ABM-IMT-3950	MT2	M3 - M6 (1/8" - 1/4")
ABM-IMT-3951	MT2	M3 - M12 (1/8" - 1/2")
ABM-IMT-3952	MT2	M10 - M20 (3/8" - 3/4")
ABM-IMT-3953	MT3	M3 - M12 (1/8" - 1/2")
ABM-IMT-3954	MT3	M10 - M20 (3/8" - 3/4")
ABM-IMT-3955	MT3	M10 - M25 (3/8" - 1")
ABM-IMT-3956	MT4	M10 - M25 (3/8" - 1")



Heavy Duty Jack Screw Set

Item Code No.
ABM-IMT-4725



Machinist Jack (Light Duty)

Item Code No.
ABM-IMT-4610



- It's used in any place where leveling is necessary.
- Machinist jack finds application on drill presses, milling machines, planers etc.
- Machinist's jack is a type of jack screw .
A jackscrew, or screw jack (a type of jack operated by turning a leadscrew).
- Made of heavy cast steel.
- Adjustable screw and tilting swivel head.
- Has 1" adjustment.
- Range 3" - 4" (75 - 100 mm).
- Hardened and Tempered.
- Lifting Capacity is approximately 1000 lbs / 454 Kgs.

- Versatile set which includes jack, extension bases and attachments.
- Used for levelling work on planer beds, upright drills and setting up machinery.
- Ability to lift 1000 lbs.
- Very useful for tool room and machine shop.
- Jack body alone has a range of 2-1/4" to 3-3/8" (57 to 85 mm).

Machinist Jacks (Heavy Duty)



Item Code No.
ABM-IMT-4660

- Base is made of heavy cast steel with adjustable screw with lock nut for permanent positioning.
- Has 1" adjustment. Overall length 3" when closed.

T Slot Cleaner



Item Code No.
ABM-IMT-4665

- T slot cleaner used for cleaning chips and debris out of the t-slots on your tables. This handy tool very useful item for every Machinist. Much safer than blowing chips out with air.
- Widely used product.
- Every Machine and Machinist needs one.
- 5-1/8" (130 mm) long and 1-1/4" (32 mm) Wide
- Black Shiny Finish.

Lathe Carriers

- Made of robust and rigid construction for maximum strength.
- Manufactured from high grade iron.
- Provided with square head screw.
- Sizes above and including 4" are fitted with two screws instead of one.

Straight Tail Item Code No.	Bent Tail Item Code No.	Capacity	
		Inch	mm
ABM-IMT-4430	ABM-IMT-4449	1/4"	6
ABM-IMT-4431	ABM-IMT-4450	3/8"	10
ABM-IMT-4432	ABM-IMT-4451	1/2"	13
ABM-IMT-4433	ABM-IMT-4452	3/4"	20
ABM-IMT-4434	ABM-IMT-4453	1"	25
ABM-IMT-4435	ABM-IMT-4454	1-1/4"	30
ABM-IMT-4436	ABM-IMT-4455	1-1/2"	40
ABM-IMT-4437	ABM-IMT-4456	1-3/4"	45
ABM-IMT-4438	ABM-IMT-4457	2"	50
ABM-IMT-4439	ABM-IMT-4458	2-1/4"	55
ABM-IMT-4440	ABM-IMT-4459	2-1/2"	65
ABM-IMT-4441	ABM-IMT-4460	2-3/4"	70
ABM-IMT-4442	ABM-IMT-4461	3"	75
ABM-IMT-4443	ABM-IMT-4462	3-1/4"	80
ABM-IMT-4444	ABM-IMT-4463	3-1/2"	90
ABM-IMT-4445	ABM-IMT-4464	4"	100
ABM-IMT-4446	ABM-IMT-4465	4-1/2"	115
ABM-IMT-4447	ABM-IMT-4466	5"	125
ABM-IMT-4448	ABM-IMT-4467	6"	150



Grinding Carriers (Dogs)

- Carriers for grinding machines and light lathes.
- Made of malleable iron.
- Shiny Black finish.

Item Code No.	Capacity	
	Inch	mm
ABM-IMT-4490	1/4"	6
ABM-IMT-4491	3/8"	9
ABM-IMT-4492	1/2"	12
ABM-IMT-4493	5/8"	16
ABM-IMT-4494	3/4"	19
ABM-IMT-4495	1"	25
ABM-IMT-4496	1-1/4"	30
ABM-IMT-4497	1-1/2"	38
ABM-IMT-4498	1-3/4"	44
ABM-IMT-4499	2"	50
ABM-IMT-4500	2-1/2"	63
ABM-IMT-4501	3"	75
ABM-IMT-4502	3-1/2"	90
ABM-IMT-4503	4"	100
ABM-IMT-4504	Set of six grinding carriers 1/4" to 1"	
ABM-IMT-4505	Set of ten grinding carriers 1/4" to 2"	





File Handles (Wooden)



- Made from High quality wood.
- Wood properly dried and seasoned.
- Handles comes with steel Ferrules.
- Available in three sizes

Item Code No.	Handle Length	
	Inch	mm
ABM-IMT-4670	4"	7/8"
ABM-IMT-4671	4-1/2"	1"
ABM-IMT-4672	4-3/4"	1-3/16"

File Handles (Plastic)



- Made from high quality unbreakable plastic.
- The steel ferrule is fitted inside the plastic handle with internal thread.
- Steel ferrule is hardened and tempered so that while affixing on the file the thread should be formed automatically while tightening the file handle.
- Available in Small, Medium and Big sizes.

Item Code No.	Sizes
ABM-IMT-4690	Small
ABM-IMT-4691	Medium
ABM-IMT-4692	Large

Tap Guide (Knurled Body)



Item Code No.
ABM-IMT-4715

- Knurled for easy handling.
- 1/2" Dia. Hardened Shank.
- 3/16" Dia. Hardened Tension Pin.
- Adjustable Tension Spring. Spring loaded Mechanism.
- Reversible Tension Pin for Male and Female hole centering of Tap.
- With this tool you start every tap straight.
- Packed in an attractive Plastic pouch.

Tap Guide (Spring Centre)



Item Code No.
ABM-IMT-4720

- The stroke of centre will follow the tap assuring straight and accurate hand tapped threads.
- One Universal size for all tapping application.
- Spring centre is made of precise Ground Alloy Steel.
- Point Hardened to 50-55 HRC.
- For execution of the Center's body is to be gripped in a drill chuck or the collets while hardened point is inserted into the centre of the Tapping Handle.

Machine Hand Tap Guide

- Provides Sensitive feel for Hand tapping Small Holes on Milling Machines, Drilling Presses and Lathes.
- Starts every hole straight and prevents tap breakage.
- Shank Dia. 3/8", Handle Dia. 1".
- No. 0 to No. 12 Tap Capacity.
- Overall Length in Closed position 6-1/2".



Item Code No.
ABM-IMT-4710

5C Collet Fixture



Item Code No.
ABM-IMT-8690

- 5C collet for secure & accurate milling, tapping, drilling, reaming, grinding & slotting etc.
- Can be Mounted on any angle plate, for vertical & Horizontal use.
- You can Use any standard 5C collet for a capacity 1-1/8" round.
- Base Dimension: 4-1/4" x 5" (108 mm x 127 mm)
- Overall Height : 4-1/4" (108 mm)

5C Collet Fixture H & V

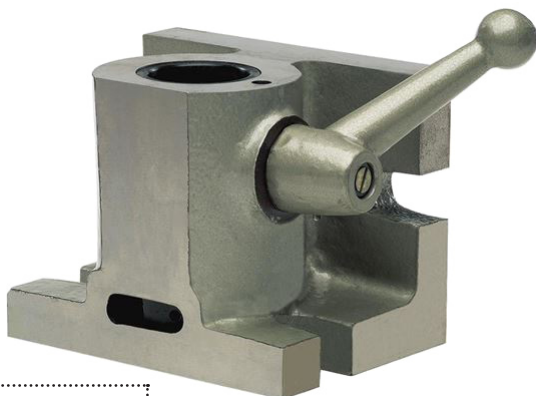

Item Code No.
ABM-IMT-8670

- 5C collet Fixture used for secure & accurate milling, tapping, drilling, reaming, grinding & slotting etc.
- Can be Mounted on any angle plate, for vertical & Horizontal use.
- Uses any standard 5C collet for a capacity 1-1/8" round.
- Base Size: 4-1/4" x 5" (108 mm x 127 mm)
- Height : 4-1/4" (108 mm)

An indispensable fixture with cam-operated sleeve for opening and closing the collet.

The collet remains in a fixed position for positive depth control. The spring-loaded handle can be indexed to any desired position for ease of operation while mounted vertically or horizontally.

Collet Stop 5C Solid Collet Stop Adjustable

- Fully threaded.
- For chucking parts to a depth of 3" (75 mm) from face of collets.
- Shiny black finish.

Item Code No.
ABM-IMT-4730

BT 40 Tool Holder Locking Device

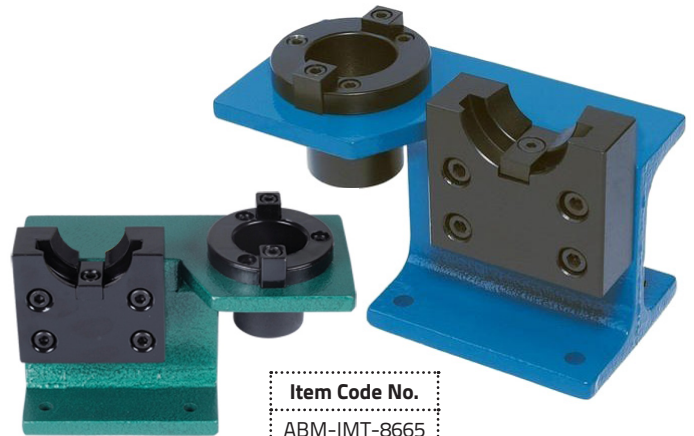

Item Code No.
ABM-IMT-8665

- Accepts both imperial & metric sized tool.
- Presence of BT 40 makes it Symmetrical about the spindle axis.
- Having greater stability & more balance at high speeds.
- Tool Holder Bearing Lock Knife Seat Block Locking Device BT40 Ball Lock Cutter For Automatic Tool Change Cutting

Drill Stop Set



Item Code No.
ABM-IMT-8660

- Set Contains 7 Pcs With 1/8", 3/16", 1/4", 5/16", 3/8", 7/16" & 1/2" Diameter.
- Used As A Stopper Or Indicator To Drill Desired Depth of Holes And Prevents Excessive Drilling.



Work Stop

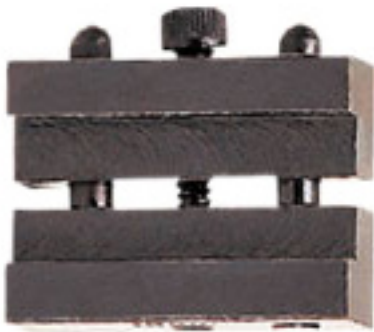

Item Code No.

ABM-IMT-4735

- Adjustable, Spring Loaded clamp for vises.
- Fits all milling vises with 3/8" (9.5 mm) thru 3/4" (19.0 mm) wide jaws.
- Body 1" (25 mm) wide with two steel guide pins for positive clamping.
- Mounts quickly, with one socket head screw.

Quill Feed Handle

Item Code No.

ABM-IMT-4780



- A Time saving accessory for bridgeport operators.
- Eliminates pulling Off/Resetting the quill feed handle for any repositioning.
- Flick of wrist retracts pin from index plate of the quill feed mechanism and lets you move handle into any desired position.
- Spring pushes pin back from quill feed actuation up or down.
- Speeds operations considerably, particularly for deep hole drilling etc.
- Replaces conventional feed handle in seconds, no holes to be drilled.
- Heavy duty construction.

Quill Stop



Item Code No.

ABM-IMT-4740

- Quick Action Clip.
- Clips on quill easily for rapid depth setting.
- Top on bottom positioning.
- Easily removable when not being used.

Knobs



- Suitable for many adjustment clamping or locating devices.
- Knurled head provides non-slip finger grip.
- Black shiny finish.
- Available in tapped type.

Knurled Knobs Item Code No.	Thread Size	Head Diameter
ABM-IMT-4760	10 - 24	3/4"
ABM-IMT-4761	1/4" - 20	1"
ABM-IMT-4762	3/8" - 16	1-1/4"
ABM-IMT-4763	1/2" - 13	1-1/2"
ABM-IMT-4764	5/8" - 11	2"
ABM-IMT-4765	3/4" - 10	2-1/2"

Hand Knob Star Type Item Code No.	Thread Size	Head Diameter
ABM-IMT-4766	1/4" - 20	1"
ABM-IMT-4767	5/16" - 18	1-1/2"
ABM-IMT-4768	3/8" - 16	2"
ABM-IMT-4769	1/2" - 13	2-1/2"
ABM-IMT-4770	5/8" - 11	2-1/2"
ABM-IMT-4771	3/4" - 10	3"



Independent 4 Jaw Lathe Chuck (Dog Chuck)



- Independent 4 Jaws Lathe Chuck Have Each Jaw Mounted On A Thread Spindle Allowing Independent Adjustment.
- Hardened Solid Jaws.
- Sizes Up to 96". Bigger sizes also available.
- Flat Back.

Item Code No.	Chuck Size	
	Inch	mm
ABM-IMT-4530	4	100
ABM-IMT-4531	6	150
ABM-IMT-4532	8	200
ABM-IMT-4533	10	250
ABM-IMT-4534	12	300
ABM-IMT-4535	14	350
ABM-IMT-4536	16	400
ABM-IMT-4537	18	450
ABM-IMT-4538	20	500
ABM-IMT-4539	24	600

Item Code No.	Chuck Size	
	Inch	mm
ABM-IMT-4540	30	750
ABM-IMT-4541	36	900
ABM-IMT-4542	42	1050
ABM-IMT-4543	48	1200
ABM-IMT-4544	60	1500
ABM-IMT-4545	72	1800
ABM-IMT-4546	80	2000
ABM-IMT-4547	84	2100
ABM-IMT-4548	96	2400

Bigger Sizes also available

Self Centering lathe Chuck (True Chuck)

- Used For Universal Application
- Scrolls Are Forged, Balanced And Hardened.
- All Supplied With Two Sets Of Solid Jaws Internal And External Stepped.
- Available in 3 Jaws Chuck and 4 Jaw Chucks.
- Bigger sizes also available.



Item Code No.	Chuck Size
ABM-IMT-4560	80 mm
ABM-IMT-4561	85 mm
ABM-IMT-4562	100 mm
ABM-IMT-4563	125 mm
ABM-IMT-4564	160 mm
ABM-IMT-4565	200 mm
ABM-IMT-4566	250 mm
ABM-IMT-4567	315 mm
ABM-IMT-4568	400 mm

Lathe Chuck Keys

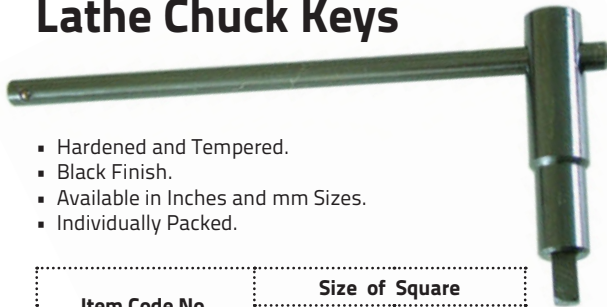

- Hardened and Tempered.
- Black Finish.
- Available in Inches and mm Sizes.
- Individually Packed.

Item Code No.	Size of Square	
	Inch	mm
ABM-IMT-4590	15/64"	6.00
ABM-IMT-4591	9/32"	7.00
ABM-IMT-4592	15/32"	12.00
ABM-IMT-4593	1/4"	6.35
ABM-IMT-4594	5/16"	8.00
ABM-IMT-4595	3/8"	9.50
ABM-IMT-4596	7/16"	11.20
ABM-IMT-4597	1/2"	12.70
ABM-IMT-4598	9/16"	14.30
ABM-IMT-4599	5/8"	16.00
ABM-IMT-4600	11/16"	17.50
ABM-IMT-4601	3/4"	19.00
ABM-IMT-4602	1"	25.40

Mini Lathe Chuck With Shanks



- Self Centering Scroll Type Mini Lathe Chuck.
- Supplied With suitable Wrenches.
- Threaded Shanks are Interchangeable.

Item Code No.	Chuck Dia. mm	No. of Jaws	Thread Size	Shank	Drawbar mm
ABM-IMT-8415	50	3	M14x1	MT1	M6
ABM-IMT-8416	50	3	M14x1	MT2	M10
ABM-IMT-8417	50	3	M14x1	MT3	M12
ABM-IMT-8418	50	4	M14x1	MT1	M6
ABM-IMT-8419	50	4	M14x1	MT2	M10
ABM-IMT-8420	50	4	M14x1	MT3	M12
ABM-IMT-8421	65	3	M14x1	MT1	M6
ABM-IMT-8422	65	3	M14x1	MT2	M10
ABM-IMT-8423	65	3	M14x1	MT3	M12
ABM-IMT-8424	65	4	M14x1	MT1	M6
ABM-IMT-8425	65	4	M14x1	MT2	M10
ABM-IMT-8426	65	4	M14x1	MT3	M12

Safety Self Ejecting Lathe Chuck Keys



- Hardened and Tempered.
- Prevents damage to your expensive machines.
- Heavy Duty Construction.

Item Code No.	Size of Square		Overall Length	
	Inch	mm	Inch	mm
ABM-IMT-4620	7/32	5.60	2-3/8	60
ABM-IMT-4621	1/4	6.35	3-1/2	90
ABM-IMT-4622	9/32	7.00	3-1/2	90
ABM-IMT-4623	9/32	7.00	4-1/2	115
ABM-IMT-4624	5/16	8.00	4-1/2	115
ABM-IMT-4625	3/8	9.50	3	75
ABM-IMT-4626	3/8	9.50	5-1/2	140
ABM-IMT-4627	13/32	10.40	3-3/4	95
ABM-IMT-4628	13/32	10.40	5-3/4	145
ABM-IMT-4629	13/32	10.40	8-1/8	205
ABM-IMT-4630	13/32	10.40	12	300
ABM-IMT-4631	7/16	11.20	6	150
ABM-IMT-4632	15/32	12.00	8-1/16	205
ABM-IMT-4633	1/2	12.70	5-1/8	130
ABM-IMT-4634	1/2	12.70	8-1/16	205
ABM-IMT-4635	1/2	12.70	11	280
ABM-IMT-4636	1/2	12.70	14-5/8	370
ABM-IMT-4637	9/16	14.30	18-1/2	470
ABM-IMT-4638	9/16	14.30	5-1/8	130
ABM-IMT-4639	9/16	14.30	8-9/16	215
ABM-IMT-4640	9/16	14.30	9-7/16	240
ABM-IMT-4641	9/16	14.30	11-1/16	280
ABM-IMT-4642	9/16	14.30	13-13/16	350
ABM-IMT-4643	9/16	14.30	17	430
ABM-IMT-4644	9/16	14.30	18-9/16	470
ABM-IMT-4645	5/8	16.00	10-1/4	260
ABM-IMT-4646	11/16	17.50	12	300
ABM-IMT-4647	3/4	19.00	9-7/8	250

Taper Turning Attachment

With Dead Center for Lathe Machine

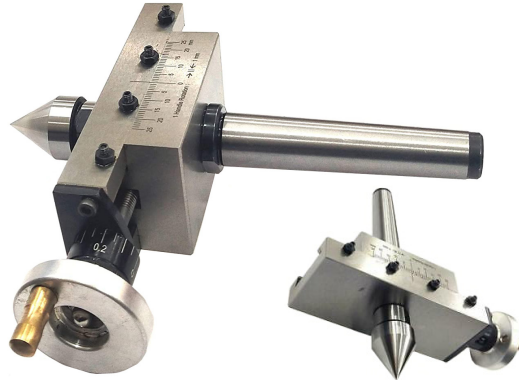

- Improved and precise quality of taper turning attachment than our previous model.
- Gives you the freedom from old traditional method of off-setting the tailstock of your lathe, when you wanted to do the metal turning in a taper profile.
- Has a Dead Center with hardened point and Precisely ground.
- This attachment has a much better control, precision and quality.
- Slide can be shifted 25 mm left & right.
- Handle rotation will off set the attachment by 1 mm.
- Also available in imperial specifications.

Item Code No.	Size
ABM-IMT-8750	MT 2
ABM-IMT-8751	MT3

Taper Turning Attachment

With Revolving Center for Lathe Machine



- Improved and precise quality of taper turning attachment than our previous model.
- Gives you the freedom from old traditional method of off-setting the tailstock of your lathe, when you wanted to do the metal turning in a taper profile.
- Has a double bearing revolving live center with hardened point.
- This attachment has a much better control, precision and quality.
- Slide can be shifted 25 mm left & right.
- Handle rotation will off set the attachment by 1 mm.
- Also available in imperial specifications.

Item Code No.	Size
ABM-IMT-8740	MT 2
ABM-IMT-8741	MT3

Taper Turning Attachment

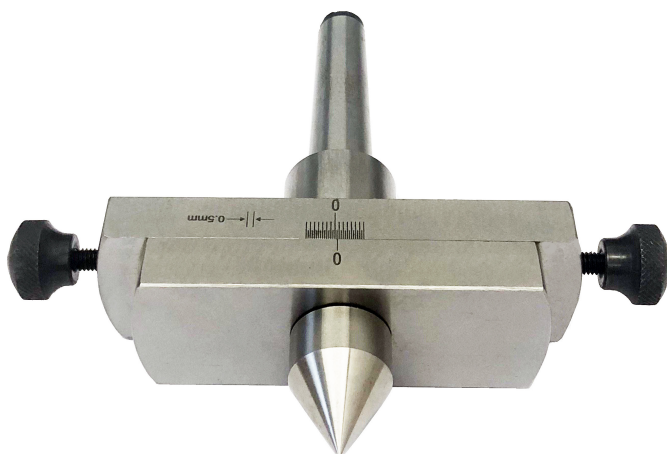

- Fully Hardened and Ground.
- Made from Alloy Steel.
- Calibrated 6" to the left or right.
- Adjustable Screws on both sides for fine adjustment.
- Easiest way to do Taper Turning, without offsetting the Tailstock.

Item Code No.	Size
ABM-IMT-6082	MT 2
ABM-IMT-6083	MT3

VEE Adaptor - For Round Bar

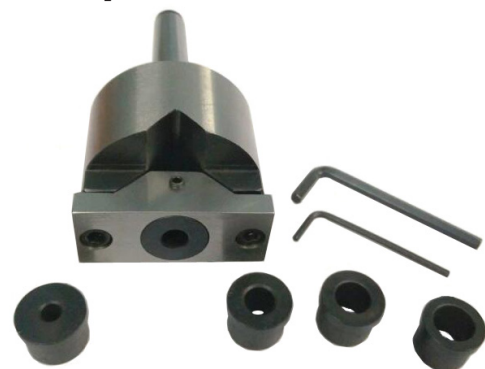

- Hardened alloy steel bushings are interchangeable as standard to fit different Drill sizes & for a minimum break drill.
- Quality V-Adapter For Lathe's Tailstock in MT Shank
- Minimum Round Bar Diameter that can be clamped in the Vee is 5 mm & maximum diameter is 40 mm
- Interchangeable Alloy Steel Hardened Bushes are supplied to adapt different drill sizes & to ensure minimum drill breakage.

Item Code No.	Shank	Head Dia.	Holding Capacity	Bush
ABM-IMT-8015	MT1	50 mm	Min 5 mm Max 30 mm	4,6,8,10 & 12 mm
ABM-IMT-8016	MT2	62 mm	Min 8 mm Max 40 mm	6, 8, 10, 12, 14 & 16 mm
ABM-IMT-8017	MT3	62 mm	Min 8 mm Max 40 mm	6, 8, 10, 12, 14 & 16 mm

Machine Tools Accessories

Live Centre / Revolving Centre (Dual Bearing) (Econo Live Centres)

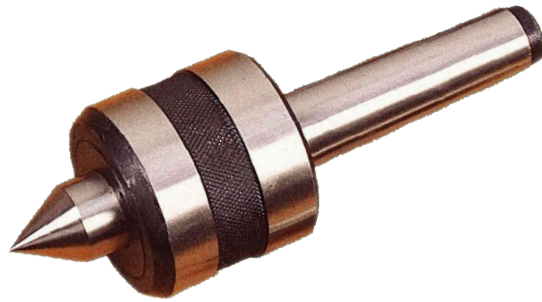

- Double Bearing Mechanism.
- Two Anti Friction Bearings.
- Made of Hardened and Ground High Carbon Steel.
- Hardened Tip 55 to 62 HRC.
- Hardened Centre Shaft with 60 degree Point.
- Special Steel Housing.
- Single Row Deep groove ball bearing and Taper Roller bearing to absorb combined radial and thrust loads

Item Code No.	Morse Taper No.	Body Diameter		Point Diameter		Overall Length	
		Inch	mm	Inch	mm	Inch	mm
ABM-IMT-4310	MT 1	1-5/16	34	11/16	18	4-3/4	120
ABM-IMT-4311	MT 2	2	50	27/32	21	5-7/8	148
ABM-IMT-4312	MT 3	2-5/16	60	15/16	24	7-1/4	185
ABM-IMT-4313	MT 4	2-1/2	63	1-1/8	28	8-5/8	220
ABM-IMT-4314	MT 5	3	75	1-1/2	36	10-1/4	260
ABM-IMT-4315	MT 6	4	100	2-1/8	53	14	355

Live Centre / Revolving Centre (Triple Bearing) (Heavy Duty)

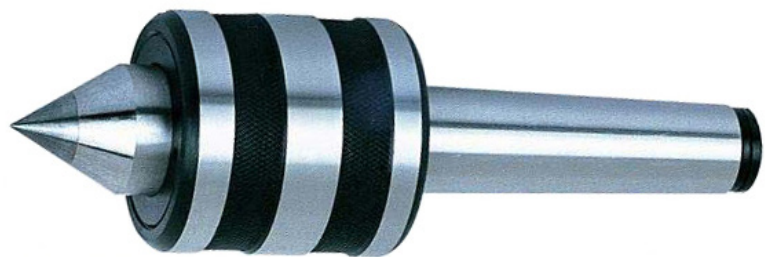

- Consists of Three anti-friction Steel bearings.
- One needle roller bearing, one thrust ball bearing and one deep groove ball bearing.
- Hardened and Ground (60-62 HRC) Steel with 60° tip angle.
- Bearings are Pre-loaded and pressed to avoid starting loads.
- Well Lubricated to protect against contaminants and coolants.
- Run out within .0002" (.005 mm)

Item Code No.	Morse Taper No.	Body Diameter		Point Diameter		Overall Length	
		Inch	mm	Inch	mm	Inch	mm
ABM-IMT-4316	MT 1	11/16	18	1-5/16	34	4-3/4	120
ABM-IMT-4317	MT 2	27/32	21	2	50	5-7/8	148
ABM-IMT-4318	MT 3	15/16	24	2-5/16	60	7-1/4	185
ABM-IMT-4319	MT 4	1-1/8	28	2-1/2	63	8-5/8	220
ABM-IMT-4320	MT 5	1-1/2	36	3	75	10-1/4	260
ABM-IMT-4321	MT 6	2-1/4	56	4	100	14	355

Multipoint Live Centre (Precision) (7 Interchangeable Nozzles)



- Comes complete with wide selection of seven interchangeable points and drift.
- Made of hardened and ground high speed steel.
- For Holding MT Shank Tools in Turrets and Automatic Lathes. used on Mini & Woodworking Lathes.
- Versatile for wide range of applications.
- Consists of three anti-friction steel bearings.
- Run out within .0002" (.005 mm).
- Set Contains : 5 Different Live Centers, 1 Pipe Center, 1 Female Center & 1 Ejecting Key.
- Packed in attractive Wooden Box.

Item Code No.	Morse Taper
ABM-IMT-4345	MT1
ABM-IMT-4346	MT2
ABM-IMT-4347	MT3
ABM-IMT-4348	MT4

High Precision Live Centres for CNC Lathes (Extended Point)



High Precision Live Centres for CNC Lathes (Standard)



- This center can be used on all CNC lathes, has a point angle of 60 degrees with double angular contact bearing, thrust bearing and needle roller bearing at the end of point in the shank.
- The extended point gives extra tool clearance for safe approach of the tool holder and lathe tools which is often needed on CNC lathes.
- Concentricity within 0.005 mm.
- Bearings are protected by a neoprene seal for longer life.
- Consists of Triple Bearings.

- This center can be used on all CNC lathes, has a point angle of 60 degrees with double angular contact bearing, thrust bearing and needle roller bearing at the end of point in the shank.
- Available in two types with a carbide point and with a tool steel point.
- Concentricity within 0.005 mm.
- Bearings are protected by a neoprene seal for longer life.

Carbide Point Item Code No.	Plain Point Item Code No.	Taper	Max RPM	Work Pc Weight
ABM-IMT-4360	ABM-IMT-4364	MT2	3000	200
ABM-IMT-4361	ABM-IMT-4365	MT3	3500	350
ABM-IMT-4362	ABM-IMT-4366	MT4	3500	500
ABM-IMT-4363	ABM-IMT-4367	MT5	2500	700

Carbide Point Item Code No.	Tool Steel Point Item Code No.	Taper	Max RPM	Work Pc Weight
ABM-IMT-4350	ABM-IMT-4354	MT2	3500	300
ABM-IMT-4351	ABM-IMT-4355	MT3	3500	400
ABM-IMT-4352	ABM-IMT-4356	MT4	3500	550
ABM-IMT-4353	ABM-IMT-4357	MT5	2500	750

High Precision Live Centres for CNC Lathes (Low Body)



- Precision Live Centres having small bodies useful on all CNC lathes, has a point angle of 60 degrees.
- Fitted with multiple roller bearings and thrust bearing at the end of the points in the shank.
- Concentricity within 0.005 mm for MT1, MT2 & MT3.
- Concentricity within 0.01 mm for MT6.
- Bearings are protected by a neoprene seal for longer life.
- Available in two types with Carbide Points or Tool Steel Points.

Carbide Point Item Code No.	Tool Steel Point Item Code No.	Taper	Max RPM	Work Pc Weight
ABM-IMT-4370	ABM-IMT-4374	MT2	4000	200
ABM-IMT-4371	ABM-IMT-4375	MT3	4000	400
ABM-IMT-4372	ABM-IMT-4376	MT4	4000	800
ABM-IMT-4373	ABM-IMT-4377	MT5	3000	1600

High Precision Live Centres for CNC Lathes (Low Body Extended Point)



- Precision Live Centres having small bodies having an extended point useful on all CNC lathes, has a point angle of 60 degrees.
- Fitted with multiple roller bearings and thrust bearing at the end of the points in the shank for Long Life and smooth operation.
- Concentricity within 0.008 mm for MT1, MT2 & MT3.
- Concentricity within 0.01 mm for MT6.
- Bearings are protected by a neoprene seal for longer life.

Carbide Point Item Code No.	Tool Steel Point Item Code No.	Taper	Max RPM	Work Pc Weight
ABM-IMT-4380	ABM-IMT-4384	MT2	4000	150
ABM-IMT-4381	ABM-IMT-4385	MT3	4000	300
ABM-IMT-4382	ABM-IMT-4386	MT4	4000	600
ABM-IMT-4383	ABM-IMT-4387	MT5	3000	1200

High Precision Live Centres for CNC Lathes (Multipoint) (Available in Standard and Low Body)

- This live centre is available in two styles, one with standard body and three interchangeable tips consisting of a tool steel point of 60 degree, a carbide point of 60 degree & a 60 degree extended point.
- The second type has a low body with same tips as the standard body live centre.
- Concentricity within 0.01 mm.
- This centre is usefull in multiple applications as the tips are interchagneable.
- Supplied with an extractor for changing points.
- Accuracy of the centre is maintained even after frequent changing of the tips in view of proven assembly design.

Standard Item Code No.	Low Body Item Code No.	Taper	Max RPM	Work Pc Weight
ABM-IMT-4400	ABM-IMT-4403	MT3	3500	150
ABM-IMT-4401	ABM-IMT-4404	MT4	3500	250
ABM-IMT-4402	ABM-IMT-4405	MT5	2500	650



Tail Stock Quick Change

Turrent Head with 3 Station

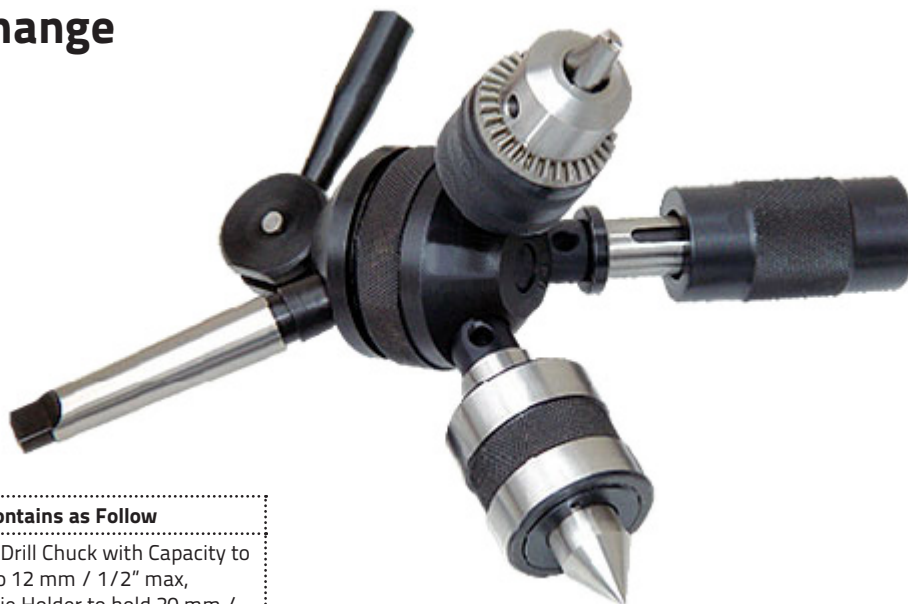

Item Code No.	Set contains as Follow
ABM-IMT-4410	1 Live Centre, 2 Drill Chuck with Capacity to hold upto 12 mm / 1/2" max, 3 Reversible Die Holder to hold 20 mm / 13/16" / 25 mm / 1" Dies for threading 4 Drill Sleeve 3/2 1 Pc 5 Drill Drift No 2 Tail Stock Shank is MT2 / MK2

Tail Stock Quick Change

Turrent Head with 4 Station



Item Code No.	Set contains as Follow
ABM-IMT-4415	1 Live Centre, 2 Drill Chuck with Capacity to hold upto 12 mm / 1/2" max 2 Nos, 3 Reversible Die Holder to hold 20 mm / 13/16" & 25 mm / 1" Dies for threading 4 Drill Sleeve 3/2 1 Pc 5 Drill Drift No 2 Tail Stock Shank is MT2 / MK2

Revolving Tailstock Chuck Adaptor for Boxford & Myford Lathe Machine



- 2MT Shank Triple Bearing Revolving Tailstock Chuck adaptor with Myford & Boxford Threads for Lathe Machine.
- Fitted with 2 Taper & 1 Radial Bearing in Body with a thread Nose 1-1/8" x 12 TPI instead of a Point Centre. (In case of Myford Thread) & thread Nose 1-1/2" x 8 TPI (In case of Boxford Thread)
- To be used for long length work piece which is difficult to turn due to no support Or in case you use a Lathe steady, it may get into your way causing problems.
- So this adaptor is the solution where you can simply put a Boxford/ Myford chuck on the nose and grip your work job between the chucks.
- Body Length (Bearing Hosing) : 51 mm wide jaws.
- Body 1" (25 mm) wide with two steel guide pins for positive clamping.
- Mounts quickly, with one socket head screw.

Item Code No.	Description	Nose Thread	Body Dia. mm	Overall Length mm
ABM-IMT-8780	Boxford Lathe	1-1/2"x 8 TPI	44.5	160
ABM-IMT-8781	Myford Lathe	1-1/8"x 12 TPI	44.5	160

Revolving Tailstock Arbor



- It is used assist small diameter of work at the tailstock where revolving center is not practical.

Item Code No.	Size	Drawbar
ABM-IMT-8405	MT2 x B16	M10
ABM-IMT-8406	MT3 x B16	M12
ABM-IMT-8407	MT2 x JT2	M10
ABM-IMT-8408	MT2 x JT3	M10
ABM-IMT-8409	MT3 x JT2	M12
ABM-IMT-8410	MT3 x JT3	M12

Slow Speed Revolving Center - Live Center



- Slow Speed Revolving Centers body made from alloy steel EN-32B and Case Hardened & tempered to a hardness of 32-40 HRC approx.
- Majority of sizes have point made from EN-31 and hardened to 60 HRC approx. for max. wear resistance.
- Very large sizes have points made from alloy steel 20MnCr5 and case hardened to 55-58 HRC to impart resistance against shearing under very heavy loads.
- Top on bottom positioning.
- Easily removable when not being used.

Item Code No.	Size	Rated load at 100 RPM Axial	Rated load at 100 RPM Radial
ABM-IMT-4325	MT2	300 Kg.	200 Kg.
ABM-IMT-4326	MT3	600 Kg.	300 Kg.
ABM-IMT-4327	MT4	800 Kg.	600 Kg.
ABM-IMT-4328	MT5	1100 Kg.	850 Kg.
ABM-IMT-4329	MT6	2100 Kg.	1500 Kg.

Revolving Center / Live Center With Chuck



- Chuck available in 50 & 65 mm (3 Jaws).
- Made from Case Hardened Steel.

Item Code No.	Shank	Chuck mm	Thread
ABM-IMT-4335	MT2	50	M12 X 1
ABM-IMT-4336	MT2	65	M14 X 1
ABM-IMT-4337	MT3	50	M12 X 1
ABM-IMT-4338	MT3	65	M14 X 1
ABM-IMT-4339	MT4	50	M12 X 1
ABM-IMT-4340	MT4	65	M14 X 1



Mini Revolving Center Live Center / Revolving Center (Mini)



- Suitable for EMCO compact & similar sized lathes.
- Made from Case Hardened Steel.

Item Code No.	Morse Taper	Body Dia. mm	Overall Length mm
ABM-IMT-4333	MT 0	23	90
ABM-IMT-4334	MT 1	23	95

Mini Lathe Live Revolving Centre for Peatol & Pultra Lathes

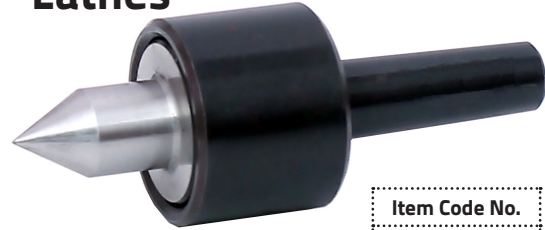

Item Code No.
ABM-IMT-8770

- Precision Small Live Revolving Centre with shank that suits PULTRA & PEATOL lathe machines.
- Small body diameter of 23 mm.
- Quality Bearings for smooth & accurate performance.
- Overall body Length 60 mm.

Half Dead Centre (Lathe Centre)

- Made of carbon steel, Hardened & Ground.
- Also called full dead centers.
- The carbide / HSS tips are brazed into the socket with a close tolerance for maximum strength.

Plain Item Code No.	Carbide Tipped Item Code No.	MT
ABM-IMT-4270	ABM-IMT-4277	0
ABM-IMT-4271	ABM-IMT-4278	1
ABM-IMT-4272	ABM-IMT-4279	2
ABM-IMT-4273	ABM-IMT-4280	3
ABM-IMT-4274	ABM-IMT-4281	4
ABM-IMT-4275	ABM-IMT-4282	5
ABM-IMT-4276	ABM-IMT-4283	6



Dead Center (Lathe Centre) (DIN 806)

- Made of carbon steel, Hardened & Ground to DIN Standard 806 / ISO 298.
- Also called full dead centers.
- The carbide / HSS tips are brazed into the socket with a close tolerance for maximum strength.

Plain Item Code No.	Carbide Tipped Item Code No.	HSS Tipped Item Code No.	MT	Body Dia. mm	Total Length	
					Inch	mm
ABM-IMT-4230	ABM-IMT-4237	ABM-IMT-4244	0	9.2	2-3/4"	70
ABM-IMT-4231	ABM-IMT-4238	ABM-IMT-4245	1	12.2	3-3/16"	80
ABM-IMT-4232	ABM-IMT-4239	ABM-IMT-4246	2	18.0	4"	100
ABM-IMT-4233	ABM-IMT-4240	ABM-IMT-4247	3	24.1	5"	125
ABM-IMT-4234	ABM-IMT-4241	ABM-IMT-4248	4	31.6	6-3/8"	160
ABM-IMT-4235	ABM-IMT-4242	ABM-IMT-4249	5	44.7	8"	200
ABM-IMT-4236	ABM-IMT-4243	ABM-IMT-4250	6	63.8	10-5/8"	270



Bull Nose Live Centers

Designed to hold pipe and hollow work.

- Preloaded bearings to achieve good thrust and radial capacities.
- Head made from heat treated hardened high carbon alloy steel.
- Head hardened to 55 - 60 HRC



Item Code No.	Morse Taper No.	Head Diameter		Nose Length		Nose Dia.		Angle
		Inch	mm	Inch	mm	Inch	mm	
ABM-IMT-4300	MT 2	2.48	63	1.42	36	0.46	11.7	70 Degree
ABM-IMT-4301	MT 3	3.07	78	1.65	42	0.71	18	70 Degree
ABM-IMT-4302	MT 4	5.04	128	2.45	62	1.38	35	75 Degree
ABM-IMT-4303	MT 5	5.80	147	2.90	73	1.38	35	75 Degree

Bevel Revolving Tube Pipe Centres

- Machining Pipes And Similar Hollow Shaft Materials With a High Thrust Capacity.
- Bevel Section Is Ground After assembly Running In Its Own Bearing.
- Designed to hold hollow & pipe Works.
- Manufactured from heat treated high carbon Alloy steel.
- Cone Angle – 60 degrees.

Item Code No.	Morse Taper No.	Capacity Minimum		Capacity Maximum	
		Inch	mm	Inch	mm
ABM-IMT-8305	MT 2	3/4"	19	3-5/32"	80
ABM-IMT-8306	MT 2	1"	26	3"	75
ABM-IMT-8307	MT 2	1-1/2"	38	2"	50
ABM-IMT-8308	MT 3	25/32"	20	3-47/64"	95
ABM-IMT-8309	MT 3	1"	26	2"	50
ABM-IMT-8310	MT 3	1-1/2"	38	3"	75
ABM-IMT-8311	MT 3	1-3/8"	34	4"	100
ABM-IMT-8312	MT 4	1-3/16"	29	5"	125
ABM-IMT-8313	MT 4	1"	26	2"	50
ABM-IMT-8314	MT 4	1-1/2"	38	3"	75
ABM-IMT-8315	MT 4	2"	51	3-1/2"	88
ABM-IMT-8316	MT 4	2-1/2"	64	4"	100
ABM-IMT-8317	MT 4	3"	76	6"	150
ABM-IMT-8318	MT 5	1-17/64"	32	6"	150
ABM-IMT-8319	MT 5	2"	51	3-1/2"	88
ABM-IMT-8320	MT 5	2-1/2"	64	4"	100
ABM-IMT-8321	MT 5	3"	76	6"	150
ABM-IMT-8322	MT 6	2-1/2"	64	4"	100
ABM-IMT-8323	MT 6	3"	76	6"	150
ABM-IMT-8324	MT 6	4"	102	8"	200





Taper & Parallel Test Bars / Mandrels



- Manufactured to high precision from alloy steel and heat treated a hardness of 62HRC \pm 2 HRC.
- Each piece is inspected for concentricity within 0.0001" and parallelism.
- Useful for alignment test between centers as well as in Morse Taper spindles.
- A Must tool in workshop for testing Lathe Machines.
- Fits between headstock and tailstock.

The Inspection Mandrels are used for checking the alignment of machine Spindle axis.

A Mandrel with a tapered shank serves to represent materially an axis of rotation, so that the axis can be checked for alignment.

A Mandrel mounted between centers provides a reference straight – line joining the two points (centers), so as to check the alignment of the centers.

Taper Test Mandrels Item Code No.	Shank	Holding Dia.	
		Inch	mm
ABM-IMT-4000	MT 1	6	150
ABM-IMT-4001	MT 2	11-1/8	283
ABM-IMT-4002	MT 3	13-3/16	335
ABM-IMT-4003	MT 4	15-1/4	386
ABM-IMT-4004	MT 5	17-1/2	442
ABM-IMT-4005	MT 6	19-7/8	300
ABM-IMT-4006	ISO 40	12	300
ABM-IMT-4007	ISO 50	12	300

Other sizes and Large sizes on request

Parallel Test Mandrels Item Code No.	Shank mm	Size mm
ABM-IMT-8510	40	300
ABM-IMT-8511	40	500
ABM-IMT-8512	40	600
ABM-IMT-8513	50	300
ABM-IMT-8514	50	500
ABM-IMT-8515	50	600
ABM-IMT-8516	60	300
ABM-IMT-8517	60	500
ABM-IMT-8518	60	600
ABM-IMT-8519	80	750
ABM-IMT-8520	80	900
ABM-IMT-8521	80	1000
ABM-IMT-8522	100	1200

Other sizes and Large sizes on request

Straight Shank Arbors Drill Chuck Arbor



Item Code No.	Shank Diameter	Shank Length	Jacob Taper
ABM-IMT-3800	3/8"	2-1/2"	0
ABM-IMT-3801	3/8"	2-1/2"	1
ABM-IMT-3802	3/8"	2-1/2"	2
ABM-IMT-3803	1/2"	2-1/2"	0
ABM-IMT-3804	1/2"	2-1/2"	1
ABM-IMT-3805	1/2"	2-1/2"	2
ABM-IMT-3806	1/2"	2-1/2"	3
ABM-IMT-3807	1/2"	2-1/2"	4
ABM-IMT-3808	1/2"	2-1/2"	6
ABM-IMT-3809	1/2"	2-1/2"	33
ABM-IMT-3810	5/8"	2-1/2"	0
ABM-IMT-3811	5/8"	2-1/2"	1
ABM-IMT-3812	5/8"	2-1/2"	2
ABM-IMT-3813	5/8"	2-1/2"	3
ABM-IMT-3814	5/8"	2-1/2"	4
ABM-IMT-3815	5/8"	2-1/2"	6
ABM-IMT-3816	5/8"	2-1/2"	33
ABM-IMT-3817	3/4"	3"	0
ABM-IMT-3818	3/4"	3"	1
ABM-IMT-3819	3/4"	3"	2
ABM-IMT-3820	3/4"	3"	3
ABM-IMT-3821	3/4"	3"	4
ABM-IMT-3822	3/4"	3"	6
ABM-IMT-3823	3/4"	3"	33
ABM-IMT-3824	1"	3"	0
ABM-IMT-3825	1"	3"	1
ABM-IMT-3826	1"	3"	2
ABM-IMT-3827	1"	3"	3
ABM-IMT-3828	1"	3"	4
ABM-IMT-3829	1"	3"	5
ABM-IMT-3830	1"	3"	6
ABM-IMT-3831	1"	3"	33
ABM-IMT-3832	1-1/2"	4"	3
ABM-IMT-3833	1-1/2"	4"	4
ABM-IMT-3834	1-3/4"	4"	3
ABM-IMT-3835	1-3/4"	4"	4

Drill Chuck Arbors (Taper Shank Arbors)

- Precision Ground to Master Gauges.
- Guarantee finest possible accuracy & fit.
- Individually packed.
- Taper shank MT / JT, MT/B.



MT/JT Item Code No.	Morse Shank Taper	Jacob Back Taper	MT/JT Item Code No.	Morse Shank Taper	Jacob Back Taper
ABM-IMT-3522	0	0	ABM-IMT-3543	2	33
ABM-IMT-3523	0	1	ABM-IMT-3544	3	1
ABM-IMT-3524	0	2	ABM-IMT-3545	3	2
ABM-IMT-3525	0	3	ABM-IMT-3546	3	3
ABM-IMT-3526	0	6	ABM-IMT-3547	3	4
ABM-IMT-3527	0	33	ABM-IMT-3548	3	5
ABM-IMT-3528	1	0	ABM-IMT-3549	3	6
ABM-IMT-3529	1	1	ABM-IMT-3550	3	33
ABM-IMT-3530	1	2	ABM-IMT-3551	4	2
ABM-IMT-3531	1	3	ABM-IMT-3552	4	3
ABM-IMT-3532	1	4	ABM-IMT-3553	4	4
ABM-IMT-3533	1	5	ABM-IMT-3554	4	5
ABM-IMT-3534	1	6	ABM-IMT-3555	4	6
ABM-IMT-3535	1	33	ABM-IMT-3556	4	33
ABM-IMT-3536	2	0	ABM-IMT-3557	5	2
ABM-IMT-3537	2	1	ABM-IMT-3558	5	3
ABM-IMT-3538	2	2	ABM-IMT-3559	5	4
ABM-IMT-3539	2	3	ABM-IMT-3560	5	5
ABM-IMT-3540	2	4	ABM-IMT-3561	5	6
ABM-IMT-3541	2	5	ABM-IMT-3562	5	33
ABM-IMT-3542	2	6			

MT/B DIN 238 Item Code No.	Drill Chuck Taper	Morse Shank Morse Taper	Total Length mm
ABM-IMT-3600	B 10	1	86
ABM-IMT-3601	B 10	2	105
ABM-IMT-3602	B 12	1	89
ABM-IMT-3603	B 12	2	106
ABM-IMT-3604	B 12	3	124
ABM-IMT-3605	B 16	1	99
ABM-IMT-3606	B 16	2	112
ABM-IMT-3607	B 16	3	134
ABM-IMT-3608	B 16	4	156
ABM-IMT-3609	B 18	1	107
ABM-IMT-3610	B 18	2	119
ABM-IMT-3611	B 18	3	140
ABM-IMT-3612	B 18	4	165
ABM-IMT-3613	B 22	2	130
ABM-IMT-3614	B 22	3	147
ABM-IMT-3615	B 22	4	176
ABM-IMT-3616	B 24	3	157
ABM-IMT-3617	B 24	4	186
ABM-IMT-3618	B24	5	196

Blank End Arbors

- These Shanks can be modified to suit individual requirements for mounting cutters etc.
- Precision ground accurate shank available in two styles with tangs and draw bar threaded.
- Manufactured from mild steel for easy machining.



Tang Arbors Item Code No.	Draw Bar Threaded Arbors Item Code No.	Shank Taper	Dia.	Draw Bar Threads
ABM-IMT-3700	ABM-IMT-3709	MT1	1"	1/4 BSW
ABM-IMT-3701	ABM-IMT-3710	MT2	1"	3/8 x 16
ABM-IMT-3702	ABM-IMT-3711	MT3	1"	3/8 x 16
ABM-IMT-3703	ABM-IMT-3712	MT4	1"	3/8 x 16
ABM-IMT-3704	ABM-IMT-3713	MT1	25 MM	M6
ABM-IMT-3705	ABM-IMT-3714	MT2	25 MM	M10
ABM-IMT-3706	ABM-IMT-3715	MT3	25 MM	M10
ABM-IMT-3707	ABM-IMT-3716	MT4	25 MM	M10
ABM-IMT-3708	ABM-IMT-3717	R8	1-1/4"	7/16 UNF



Solid Sockets (Turret Sockets)



- Straight Shank With Morse Taper Hole.
- Hardened And Ground.
- For Holding MT Shank Tools In Turrets And Automatic Lathes.

Inch Item Code No.	MM Item Code No.	Morse Taper Inside Hole	Shank Diameter		Shank Length	
			Inch	mm	Inch	mm
ABM-IMT-4160	ABM-IMT-4190	MT 1	1	25	3-1/2	88
ABM-IMT-4161	ABM-IMT-4191	MT 1	1-1/4	32	3-1/2	88
ABM-IMT-4162	ABM-IMT-4192	MT 1	1-1/2	38	3-1/2	88
ABM-IMT-4163	ABM-IMT-4193	MT 2	1	25	4	100
ABM-IMT-4164	ABM-IMT-4194	MT 2	1-1/4	32	4	100
ABM-IMT-4165	ABM-IMT-4195	MT 2	1-1/2	38	4	100
ABM-IMT-4166	ABM-IMT-4196	MT 2	1-3/4	44	4	100
ABM-IMT-4167	ABM-IMT-4197	MT 2	2	50	4	100
ABM-IMT-4168	ABM-IMT-4198	MT 3	1-1/4	32	4-3/4	120
ABM-IMT-4169	ABM-IMT-4199	MT 3	1-1/2	38	4-3/4	120
ABM-IMT-4170	ABM-IMT-4200	MT 3	1-3/4	44	4-3/4	120
ABM-IMT-4171	ABM-IMT-4201	MT 3	2	50	4-3/4	120
ABM-IMT-4172	ABM-IMT-4202	MT 4	1-1/2	38	6	150
ABM-IMT-4173	ABM-IMT-4203	MT 4	1-3/4	44	6	150
ABM-IMT-4174	ABM-IMT-4204	MT 4	2	50	6	150
ABM-IMT-4175	ABM-IMT-4205	MT 5	2-1/4	57	7-3/8	176
ABM-IMT-4176	ABM-IMT-4206	MT 5	2-1/2	63	7-3/8	176
ABM-IMT-4177	ABM-IMT-4207	MT 6	3-1/4	82	10-1/8	251
ABM-IMT-4178	ABM-IMT-4208	MT 6	3-1/2	88	10-1/8	251

Straight Stub MT Arbor



- Taper Portion is Ground And Hardened.
- These Arbors Are Designed For Applications Where Tapered And Hardened Arbors Cannot Be Used.
- Straight Shank Portion is Soft Which Can Be Machined To Adopt For Special Application.

Item Code No.	Size	Thickness of Taper Ends
ABM-IMT-3860	MT 2 - 1"	3/8"
ABM-IMT-3861	MT 3 - 1"	3/8"
ABM-IMT-3862	MT 2 - 25 mm	M 10
ABM-IMT-3863	MT 3 - 25 mm	M 10

Threaded Arbors (Drill Chuck Arbors Threaded)



- These arbors are case hardened to 54-58 HRC for increased resistance to wear. Manufactured from high quality steel.
- These arbors are used for mounting chucks to spindles having threaded holes.

Item Code No.	Shank Size	Threads
ABM-IMT-3870	Morse Taper No. 3	3/8 - 24
ABM-IMT-3871	Morse Taper No. 3	1/2 - 20
ABM-IMT-3872	Morse Taper No. 3	5/8 - 16
ABM-IMT-3873	Morse Taper No. 2	3/8 - 24
ABM-IMT-3874	Morse Taper No. 2	1/2 - 20
ABM-IMT-3875	Morse Taper No. 2	5/8 - 16
ABM-IMT-3876	Morse Taper No. 1	3/8 - 24
ABM-IMT-3877	Morse Taper No. 1	1/2 - 20
ABM-IMT-3878	1/2" Straight	1/2 - 20
ABM-IMT-3879	1/2" Straight	3/8 - 24



Drill Sleeves (Reduction Sleeves)

- Available in both Soft and Hard type.
- Available in Workshop Grade & A Grade.
- A Grade ACC ISO 238 / DIN 2185 Made of Carbon Steel Hardened and Ground Internally and Externally.
- Workshop Grade made from Carbon Steel, External Ground and Internal Reamed Carbon Steel.
- Designed for use with Taper Shank Tools, providing accurate alignment between the two members.



Soft Type (Workshop Grade) Item Code No.	Hardened Type (A Grade) Item Code No.	Morse Taper Inside	Morse Taper Outside	Overall Length mm
ABM-IMT-4020	ABM-IMT-4040	1	2	92
ABM-IMT-4021	ABM-IMT-4041	1	3	99
ABM-IMT-4022	ABM-IMT-4042	1	4	124
ABM-IMT-4023	ABM-IMT-4043	1	5	156
ABM-IMT-4024	ABM-IMT-4044	2	3	112
ABM-IMT-4025	ABM-IMT-4045	2	4	124
ABM-IMT-4026	ABM-IMT-4046	2	5	156
ABM-IMT-4027	ABM-IMT-4047	2	6	218
ABM-IMT-4028	ABM-IMT-4048	3	4	140
ABM-IMT-4029	ABM-IMT-4049	3	5	156
ABM-IMT-4030	ABM-IMT-4050	3	6	218
ABM-IMT-4031	ABM-IMT-4051	4	5	171
ABM-IMT-4032	ABM-IMT-4052	4	6	218
ABM-IMT-4033	ABM-IMT-4053	5	6	218
ABM-IMT-4034	ABM-IMT-4054	4 Pcs. Set consisting Popular sizes 1-2, 2-3, 3-4, 4-5		

End Mill Holders

- Useful for efficient holding of endmills, slot drills or similar tooling in light and heavy duty milling machines and small lathes.
- Precisely ground externally and internally to very close tolerances with concentricity within $\pm .10$ Microns.
- Eliminates the need of a collet chuck.
- The machining area is easily visible while doing intricate components.
- Manufactured from case Hardened Steel.

Item Code No.	Shank Taper	Holding Dia.		Draw Bar Threads
		Inch	mm	
ABM-IMT-4070	R8	3/16	5	7/16 UNF
ABM-IMT-4071	R8	1/4	6	7/16 UNF
ABM-IMT-4072	R8	3/8	10	7/16 UNF
ABM-IMT-4073	R8	1/2	12	7/16 UNF
ABM-IMT-4074	R8	5/8	16	7/16 UNF
ABM-IMT-4075	MT2	3/16	5	3/8 BSW 10
ABM-IMT-4076	MT2	1/4	6	3/8 BSW 10
ABM-IMT-4077	MT2	3/8	10	3/8 BSW 10
ABM-IMT-4078	MT2	1/2	12	3/8 BSW 10
ABM-IMT-4079	MT3	3/16	5	3/8 BSW 10
ABM-IMT-4080	MT3	1/4	6	3/8 BSW 10
ABM-IMT-4081	MT3	3/8	10	3/8 BSW 10
ABM-IMT-4082	MT3	1/2	12	3/8 BSW 10



R 8 Drill Chuck Arbors



- Precision Ground to Master Gauges.
- Guarantee finest possible accuracy & fit.
- Individually Packed.
- Useful for mounting all drill chucks of Jacob / DIN Standard .

Item Code No.	Shanks	Chuck Taper	Draw Bar Thread
ABM-IMT-3730	R8	1 JT	7/16 UNF
ABM-IMT-3731	R8	2 JT	7/16 UNF
ABM-IMT-3732	R8	3 JT	7/16 UNF
ABM-IMT-3733	R8	33 JT	7/16 UNF
ABM-IMT-3734	R8	4 JT	7/16 UNF
ABM-IMT-3735	R8	6 JT	7/16 UNF
ABM-IMT-3736	R8	B10	7/16 UNF
ABM-IMT-3737	R8	B12	7/16 UNF
ABM-IMT-3738	R8	B16	7/16 UNF
ABM-IMT-3739	R8	B18	7/16 UNF

Morse Taper Arbors



- Manufactured from case hardened steel and precision ground all over.
- Draw Bar Threaded.

Item Code No.	Shank	Chuck Taper	Draw Bar Threads
ABM-IMT-3980	MT1	JT1	1/4 BSW
ABM-IMT-3981	MT1	JT1	M6
ABM-IMT-3982	MT2	JT6	3/8 BSW
ABM-IMT-3983	MT2	JT6	M10
ABM-IMT-3984	MT2	JT33	3/8 BSW
ABM-IMT-3985	MT2	JT33	M10
ABM-IMT-3986	MT2	JT3	3/8 BSW
ABM-IMT-3987	MT2	JT3	M10
ABM-IMT-3988	MT2	B16	M10
ABM-IMT-3989	MT3	JT6	3/8 BSW
ABM-IMT-3990	MT3	JT6	M10
ABM-IMT-3991	MT3	B16	M10
ABM-IMT-3992	MT4	JT2, JT3, JT4, JT5, JT6	
ABM-IMT-3993	MT5	JT3, JT4, JT5	

Expanding Arbor - 8 Pcs Set



Also known as Expanding-End Lathe Mandrel Sets

- Chuck the shank of the expanding mandrel in a collet, jaw chuck, or fixture.
- With an Allen Key tighten the hex draw bolt until it expands.
- Then machine the slotted Part larger than bore of part.
- Loosen hex draw bolt, position part, tighten draw screw. The part is now chucked and ready for machining.
- This expanding mandrel can be used with standard collets, vises, jaw chucks and many other special fixtures.
- These expanding mandrels are machinable by the customer.
- Multiple expanding mandrels are also used in other special fixtures for holding multiple workpieces 'side by side'.

Item Code No.	included Size
ABM-IMT-8287	6, 10, 12, 16, 19, 22, 25 & 32 mm
ABM-IMT-8288	1/4", 3/8", 1/2", 5/8", 3/4", 7/8", 1", 1-1/4"

Open End Sleeve with Extractor - DIN 228



Also known as OPEN END REDUCTION SLEEVE WITH EXTRACTOR

- Hardened & grounds both internal & external.

Item Code No.	Size
ABM-IMT-8280	MT 1 - MT 2
ABM-IMT-8281	MT 3 - MT 2
ABM-IMT-8282	MT 4 - MT 3

Combination Shell End Mill Adapters / Arbors



- Useful for cutter with Key way or driving slot DIN 138.
- Hardened and Tempered.

Item Code No.	Shank	Size	Draw Bar Threaded
ABM-IMT-3900	MT2	16 MM	M10
ABM-IMT-3901	MT2	22 MM	M10
ABM-IMT-3902	MT3	16 MM	M12
ABM-IMT-3903	MT3	22 MM	M12

Straight Stub Milling Arbor



- A useful tool for holding saws or bore and face cutters.
- The Thick washers and counter sunk screws permit the cutters to be positioned near the end of the arbor as well as giving enough locking power.

Item Code No.	Shank	Holding Cutter Dia	Draw Bar
ABM-IMT-3910	MT2	1"	3/8" BSW
ABM-IMT-3911	MT3	1"	3/8" BSW
ABM-IMT-3912	R8	1"	7/16" UNF

Face Mill Arbors



- Manufactured from High Quality Steel.
- Provided with a pilot for easy cutter mounting.
- Useful for holding indexable tip face mills.
- Available in three sizes 16mm, 22mm and 27 mm bore cutters.

Item Code No.	Shank	Drive Pin Dia	Spigot Dia x L	Screw	Draw Bar Threaded
ABM-IMT-3930	MT2	8 x 4 MM	16 x 16 MM	M8	3/8" BSW
ABM-IMT-3931	MT3	8 x 4 MM	16 x 16 MM	M8	3/8" BSW
ABM-IMT-3932	MT3	10 x 6 MM	22 x 19 MM	M10	3/8" BSW
ABM-IMT-3933	R8	8 x 4 MM	16 x 16 MM	M8	7/16" UNF
ABM-IMT-3934	R8	10 x 6 MM	22 x 19 MM	M10	7/16" UNF
ABM-IMT-3935	R8	12 x 6 MM	27 x 21 MM	M12	7/16" UNF

Extension Sockets

- Hardened And Ground Internally And Externally.
- As per DIN 2187.

Item Code No.	Morse Taper No.		Overall Length
	Outside	Inside	
ABM-IMT-4100	1	1	145
ABM-IMT-4101	2	1	160
ABM-IMT-4102	3	1	175
ABM-IMT-4103	4	1	200
ABM-IMT-4104	5	1	232
ABM-IMT-4105	1	2	160
ABM-IMT-4106	2	2	175
ABM-IMT-4107	3	2	194
ABM-IMT-4108	4	2	215
ABM-IMT-4109	5	2	247
ABM-IMT-4110	2	3	196
ABM-IMT-4111	3	3	215
ABM-IMT-4112	4	3	240
ABM-IMT-4113	5	3	268
ABM-IMT-4114	2	4	215
ABM-IMT-4115	3	4	240
ABM-IMT-4116	4	4	265
ABM-IMT-4117	5	4	300
ABM-IMT-4118	6	4	355
ABM-IMT-4119	3	5	268
ABM-IMT-4120	4	5	300
ABM-IMT-4121	5	5	335
ABM-IMT-4122	6	5	390
ABM-IMT-4123	6	6	470



Taper Adapters

Morse Taper Adapter



- Manufactured to precision from case hardened steel.
- Concentricity within 0.015 mm Internal Taper as per DIN 228 and external Taper R8.

Item Code No.	Outside Taper	Inside Taper	Draw Bar Thread	Overall Length	
				Inch	mm
ABM-IMT-4140	R 8	MT1	7/16" UNF	5	125
ABM-IMT-4141	R 8	MT2	7/16" UNF	5	125
ABM-IMT-4142	R 8	MT3	7/16" UNF	6	150
ABM-IMT-4143	ISO 30	MT2	1/2" or 12 mm	6	150
ABM-IMT-4144	ISO 30	MT3	5/8" or 16 mm	6	150
ABM-IMT-4145	R 8	MT4	7/16" UNF	9-3/8	245

Screw-In Spare Tangs



- Converts the drawbar threaded arbor to one with a tang.

Item Code No.	Size
ABM-IMT-8265	MT 1 x M 6
ABM-IMT-8266	MT 2 x M 10
ABM-IMT-8267	MT 3 x M 12
ABM-IMT-8268	MT 4 x M 16

Quick Change Chuck Adapter

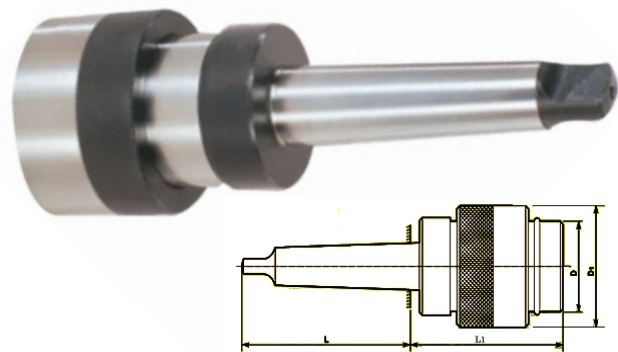

- Made from 20MnCr5 & Case Hardened to 55-58 HRC.

Item Code No.	ABM-IMT-7677	ABM-IMT-7678	ABM-IMT-7679	ABM-IMT-7680
Size	MT2	MT3	MT4	MT5
L mm	75	94	117.5	149.5
L1 mm	75	86	97.5	122.5
Bore Size mm	26	34	46	60
D mm	36	46	62	80
D1 mm	48	61	85	104
D2 mm	17.780	23.825	31.267	44.399
Suitable for Collets	CO 21, 22	CO 31, 32, 33	CO 41, 42, 43, 44	CO 51, 52, 53, 54, 55

Fixed Vertical Slide



Item Code No.
ABM-IMT-8730

- Item compatible for Myford ML7 Lathes and other smaller mini lathes.
- Table size is 125 mm x 100 mm.
- Has a reading bush at the handle for calculating accurate travel of the bed and hence a precise job.
- Clamping jobs Max job size of 3" that can be hold.
- The thread comes both in metric and Imperial Standard as per customer's requirements.
- So while placing order please mention Metric or Imperial Thread.

Mini Vertical Slide

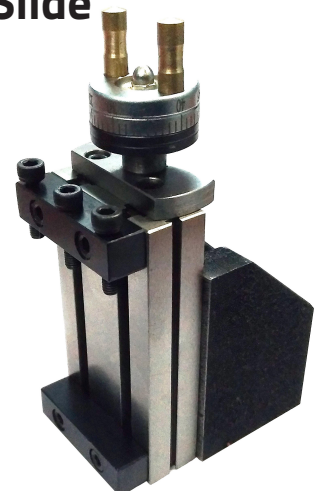

Item Code No.
ABM-VC-11472

- Suitable for Bench Lathes upto 150mm Swing
- Vertical Travel 70mm
- Base Dimension :50x55mm
- Table Size / Sliding Table : 90x50mm
- Dial Graduated to 0-50
- Jaw Opening 65 mm
- T Slot 9 mm
- High Grade casting and Smooth Finish.

Mini Vertical Slide



- Mini Vertical Slide (90 x 50 mm) for instant Milling Operation on Lathe Machine
- Small Vertical Milling Slide for Bench Small Lathes Suitable for Bench Lathes upto 150 mm Swing
- Base Dimension :50 x 55 mm
- Sliding Table :90 x 50 mm
- Vertical Travel 40 mm
- Tee- Slot width 9.5 mm Maximum
- Jaw Opening : 70 mm
- Adjustable Vice Jaws & Brass Gib
- Dial Graduated to 0-50
- Fixing hole centres is 22mm at 90° to slide face
- High Grade Casting and Smooth Finish

Item Code No.
ABM-VC-11473

Vertical Milling Attachment Slide Swivel Base



Item Code No.
ABM-VC-11474

- This Vertical Milling Slide is a direct fit on your Myford 7 or Super 7 and can be fitted to many other popular machines. It has a useful double swivel action and is fully graduated (metric)
- Vertical Milling Slide for Myford ML7 Series Lathes, Boxford, & Super 7 Lathes
- This is an accessory item compatible for Myford ML7 Lathes and other smaller mini lathes.
- Table size is 4" x 5" (100 mm x 125 mm).
- Slide Travel 80 mm Approx
- Height Inc Handle 250 mm
- Mounting Studs 30 mm between centres

Vertical Milling Slides Suitable for ML7 Lathes



Item Code No.
ABM-VC-11471

- Vertical Milling Slide for Myford ML7 Series Lathes, Boxford, & Super 7 Lathes
- This is an accessory item compatible for Myford ML7 Lathes and other smaller mini lathes.
- Table size is 4" x 5" (100 mm x 125 mm).
- Slide Travel 80 mm Approx.
- Footprint – 105 x 95 mm
- Height inc Handle – 250 mm
- Mounting Holes 10 mm dia – 40 mm between centre.

Mini Vice - For Rotary Table or Vertical Slide

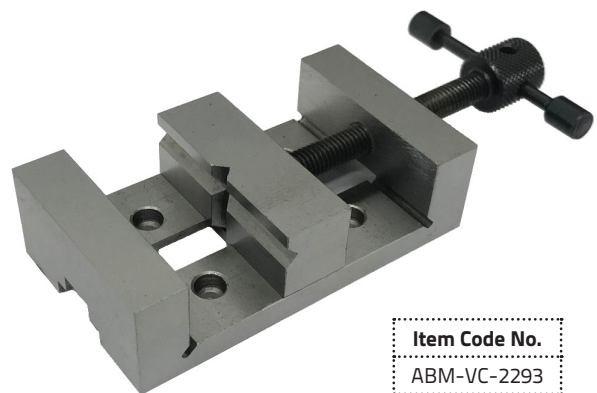

Item Code No.
ABM-VC-2293

- 4 Holes provided for mounting on Mini Vertical Slide
- Jaw Length – 2" / 50 mm
- Jaw Opening – 50 mm
- Jaw Depth – 18 mm

Vertical Sliding Table

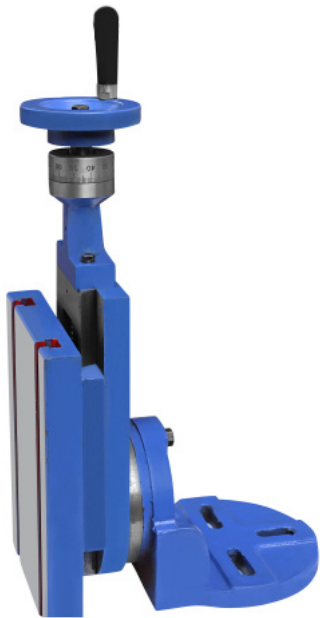

- Precision Sliding Tables are meant for accurate boring, drilling grinding and milling operations.
- Grey iron casting properly machined and grinded process provides accuracy well within 0.01mm/100mm tolerance.
- Toughened lead screw having acme threads running smoothly in phosphorus Bronze Nut.
- Dovetail slides have adjustable steel ribs for smooth running and adjustment.
- Precision ACME feed screw is running in a hot stamped phosphorus Bronze Nut thrust color for smooth operation and minimum back lash.
- Designed to fit on any Lathe, will enable you to mill slots, Key ways, grooves, flats, squares, also drilling at any angle.
- The T-Slots are machined from Solid.
- Equipped with two axis positioning.
- Dovetailed slides have adjustable steel gibs to compensate for wear.
- The surface table can swivel all round and 0° is marked to show the angular movement.
- Base have bolt slots for machine mounting.

Item Code No.	ABM-VC-11470
Size in Inches	7 x 10
Table Size mm	175 x 250
Height mm	270
Overall Length mm	465
T Slot Size mm	13
Sliding Travel	180
Swivel Graduation	180 Degree
Wheels Graduation in Inches	0.002
Weight Approx. Kg.	23.5

Small Milling Vice For Millford Lathe

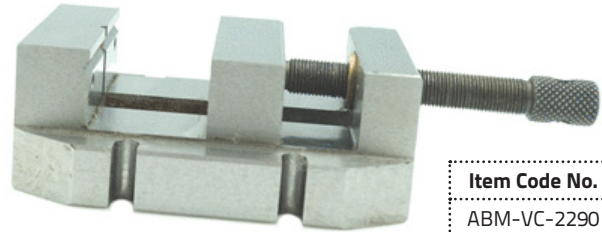

Item Code No.
ABM-VC-2290

- Small Milling Vice suitable for Myford Type Milling Slide for Myford Lathes
- This new small machine vice is suitable for many small lathes and ideal for anyone with a Myford milling slide etc.
- The fixed jaw has horizontal and vertical vees for ease of use when holding round material.
- It can be mounted using either the 2 milled outer slots or the 2 inner drilled holes.
- Suitable T nuts included. It can also be used as a standalone vice in either a horizontal or vertical position.
- Jaw Width – 60mm
- Jaw Opening – 45 mm
- Distance between slots – 75mm
- Distance Between Holes – 45mm
- Overall Height when HZ – 45mm
- Overall Height When VT – 110mm (not inc screw)
- Footprint when HZ – 110 x 85mm

Round Vice For Rotary Table or Vertical Slide



- Excellent precise compact design.
- Supplied with table fixing bolts.
- Vice has horizontal and vertical vee in moving jaw.
- Made of high grade close grain caste Iron.
- Designed to fit our 3" (75 mm) & 4" (100 mm) Rotary Tables.
- The moving jaw has V-grooves to hold Round objects.
- Again these vices are drilled in a manner that these can fit to a 3 as well 4 slot table.
- The Drills are counter bored to ensure that the fixing screws sets perfectly ensure perfect movement.

Item Code No.	Jaw Length	Jaw Depth	Jaw Opening	Suitable for Rotary Table
ABM-VC-2285	80 mm	20 mm	40 mm	4" / 100 mm
ABM-VC-2286	70 mm	20 mm	28 mm	3" / 75 mm



Vice

For Vertical Table or Vertical Slide

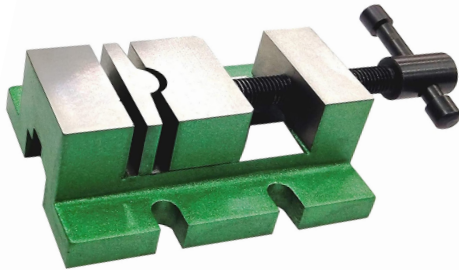

- Extra Jaw provided which helps to hold work piece in different angles.
- 4 Slots provided for mounting on vertical slide both fixed & Swivel.

Item Code No.	Jaw Length	Jaw Depth	Jaw Opening	Overall Length
ABM-VC-2295	45 mm	35 mm	30 mm	135 mm

Quick Change Tool Post

Compatible to Mount on MYFORD & MINI Lathes



Item Code No.
ABM-IMT-8760

- Quality Quick Change Tool Post known as Swiss Type compatible for direct mounting on MYFORD Lathes
- Standard Holders 12.5 mm capacity
- When it will be mounted on MYFORD ML/SUPER 7, it will give you a center height of 10 mm
- Even it will fit to a MYFORD ML10 model as well but give a 6 mm tool height.
- By doing small modifications, you can fit the same to a mini lathe as well.
- Main block Dimensions: Height 32.5 mm high x 7/16" bore
- Quick and better clamp cam action.
- Holders can be released by moving the handle.

Mini Quick Change Tool Post Holder set - Aluminium

- Quick Change Tool Post, Professional Aluminum Alloy Quick Change Tooling
- Package Toolholder Mini Lathe Tool Post and Holder Kit Set
- Quick Change Boring Bar Turning Tool Post Holder for CNC Mini Lathe
- Quick change tool post, cutter holder are major attachment of ordinary lathe, is composed of a tool post and several toolholder, according to the needs of machining, choose corresponding knife holder, can be carried out outside garden, surfacing, cut off, knurling, drilling, boring, reaming and other processing.
- Applicable to the comparison method to measure the workpiece diameter, accuracy 0.01mm.
- Toolholder for the adjusting screw nut and tool, adjust installation height, easy to operate, shortening the time loaded knife.
- Each changing tools only takes a few seconds.
- High positioning accuracy, reset accuracy within 0.01mm range, the surface quality of machined parts, precision improved.

The set comprises of the following items :
Main Block – 1 Unit
Standard Holder – 2 Unit
Boring Holder (Vee) – 1 Unit



Item Code No.	Model No.	Block Size	Bore	For Lathe Size	Set includes the Following
ABM-IMT-8370	T40	45 x 45 x 58 mm	8 & 10 mm	7" x 10", 7" x 12" 7" x 14", 7" x 16" 9" x 16"	1 Unit - Main Block 2 Unit - Turning & Facing Holder (Standard) 1 Unit - Boring Holder (O) 3/8" (9.5 mm) 1Uni - Cut Off Holder 1/52"

Quick Change Tool Post Wedge Type

- Made of steel. Perfect for 7" x 10", 7" x 12", 7" x 14" mini lathe, such as Enco, Grizzly, Little Machine, Harbor Freight and many other brand
- Wedge type tool posts are precision engineered to assure repeatability accuracy. Wedge type tool posts have the Maximum rigidity to get the chatter free performance
- The tool post comes with a blank T-Nut plate, customers need to do some machining work to make it fit into their own specific lathe T- slot
- Made from high quality, heat treated tool steel. All working parts hardened and precision ground.

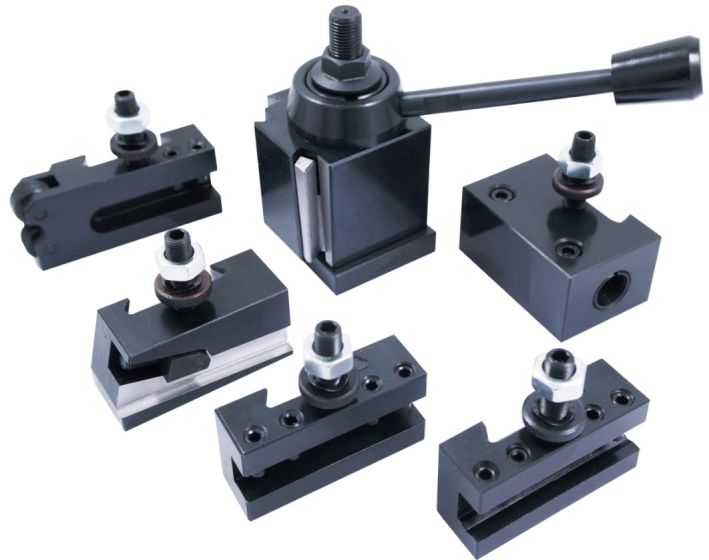

The set comprises of the following items :

- Main Block
- Turning and Facing Holder (Standard)
- Boring Holder (O)
- Boring Holder (V)
- Cut off Holder / Parting Holder
- Knurling Holder

Item Code No.	Model No.	Block Size	For lathe Swing	Set Includes the following
ABM-IMT-4750	OXA	1.75" x 1.75" x 2.5"	6" - 9" (150 - 230 mm)	1 Unit- Main Block 2 Unit- Turning and Facing Holder (Standard) 1 Unit- Boring Holder (O) 1/2" or 3/8" 1 Unit- Boring Holder (V) 13 mm 1 Unit- Cut Off Holder 1/2"
ABM-IMT-4751	AXA	2.5" x 2.5" x 3.5"	7" - 12" (180 - 300 mm)	1 Unit- Main Block 2 Unit- Turning and Facing Holder (Standard) 1 Unit- Boring Holder (O) 5/8" or 3/4" 1 Unit- Boring Holder (V) 14 mm 1 Unit- Cut Off Holder 1/2" 1 Unit- Knurling Holder
ABM-IMT-4752	BXA	--	10" - 15" (250 - 375 mm)	1 Unit- Main Block 2 Unit- Turning and Facing Holder (Standard) 1 Unit- Boring Holder (O) 1/4" or 5/8" 1 Unit- Boring Holder (V) 7/8" 1 Unit- Cut Off Holder 11/16" 1 Unit- Knurling Holder
ABM-IMT-4753	CXA	--	13" - 18" (325 - 450 mm)	1 Unit- Main Block 2 Unit- Turning and Facing Holder (Standard) 1 Unit- Boring Holder (O) 1/2" or 3/4" 1 Unit- Boring Holder (V) 1" 1 Unit- Cut Off Holder 3/4" 1 Unit- Knurling Holder
ABM-IMT-4754	CA	--	14" - 20" (350 - 500 mm)	1 Unit- Main Block 2 Unit- Turning and Facing Holder (Standard) 1 Unit- Boring Holder (O) 1/2" or 1" 1 Unit- Boring Holder (V) 1-1/4" 1 Unit- Cut Off Holder 7/8" 1 Unit- Knurling Holder
ABM-IMT-4755	DA	--	17" - 32" (425 - 800 mm)	1 Unit- Main Block 2 Unit- Turning and Facing Holder (Standard) 1 Unit- Boring Holder (O) 3/4" or 1-1/4" 1 Unit- Boring Holder (V) 1"-9/16" 1 Unit- Cut Off Holder 1-1/8" 1 Unit- Knurling Holder

Quick Change Tool Post Set

Multifix - 40 Position - 5 Pcs. Set



Toolpost and toolholder profile-ground. Easy to operate. Any number of different toolholders can be used. 40 tool-bit positions. Adjustment for height of the tool bit is controlled by a knurled head screw without using packing plates or shims. Loosening and locking of any toolholder is performed by simple eccentric clamping. Save time by changing the toolholder from the top without moving longitudinal or traverse slides. Bore with longitudinal feed by using toolholder with inner taper. Eliminates complicated boring with the tailstock.

Mounting on Lathe:

Profile-ground serrated toolpost to be mounted with support clamping bolt. The centering disk should be bored to the dimension of the clamping bolt (snug fit not necessary). It is recommended that the toolpost with clamped toolholder and boring bar be aligned at a right angle to the face plate. The toolpost is locked on the support by means of two set pins. The marking point should then be set on "0" and the nut of the clamping bolt tightened.

The set comprises of the following items:

- 1 Unit- 40 Position Toolpost Body C
- 3 Unit – Standard Tool Holders
- 1 Unit- Boring Bar Holder (vee)
- Toolpost spanner & toolholder key

Item Code No.	Model	Block Height	Mounting Bore	For lathe Swing	Set Includes the following
ABM-IMT-8330	A0	33 mm	20 mm (10.2 mm)	120 - 200 mm	1 Unit - Main Block 3 Unit - Turning and Facing Holders (Standard) 1 Unit - Boring Holder (V)
ABM-IMT-8331	A1	54 mm	13 mm (6 mm)	150 - 300 mm	1 Unit - Main Block 3 Unit - Turning and Facing Holders (Standard) 1 Unit - Boring Holder (V)
ABM-IMT-8332	A2	70 mm	20 mm (10.2 mm)	200 - 400 mm	1 Unit - Main Block 3 Unit - Turning and Facing Holders (Standard) 1 Unit - Boring Holder (V)
ABM-IMT-8333	A3	77 mm	25 mm (14 mm)	300 - 500 mm	1 Unit - Main Block 3 Unit - Turning and Facing Holders (Standard) 1 Unit - Boring Holder (V)
ABM-IMT-8334	A4	107 mm	32 mm (15 mm)	400 - 700	1 Unit - Main Block 3 Unit - Turning and Facing Holders (Standard) 1 Unit - Boring Holder (V)

Item Code No.	Style	Suitable for Item Code	Capacity
ABM-IMT-8337	Standard Holder	Suitable for ABM-IMT-8330	12 mm
ABM-IMT-8338	Standard Holder	Suitable for ABM-IMT-8331	20 mm
ABM-IMT-8339	Standard Holder	Suitable for ABM-IMT-8332	30 mm
ABM-IMT-8340	Boring Holder (V)	Suitable for ABM-IMT-8330	12 mm
ABM-IMT-8341	Boring Holder (V)	Suitable for ABM-IMT-8331	20 mm
ABM-IMT-8342	Boring Holder (V)	Suitable for ABM-IMT-8332	30 mm

Quick Change Tool Post Dixon Type - 5 Pcs Set

- Useful tool post for quick changing.
- Hardened and tempered body.
- Comes with Spanner & Tool Bit.
- Packed in finished Wooden Box.

SET CONTAINS (5 Pcs.)
 Mounting Block 1 No.
 Standard Holder 2 No.
 Vee - Boring Holder 1 No.
 Parting Holder 1 No.

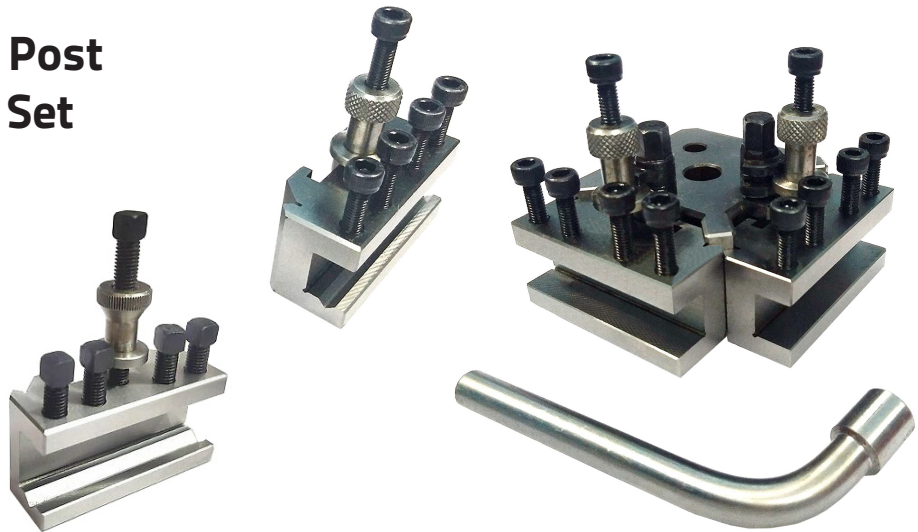

Item Code No.	Block Dimension l x b x h - mm	Mounting Bore	Suitable Lathe Center Height	Suitable for Model	Lathes
ABM-IMT-4910	58 x 58 x 37	7/16" (11.2 mm)	90 - 115 mm	T-37	MYFORD ML7, Super Seven Lathes & Similar Sized
ABM-IMT-4911	73 x 73 x 51	3/4" (19 mm) Can be reduced	125 - 150 mm (5-1/2" - 6")	T-51	BOXFORD Lathes
ABM-IMT-4912	73 x 73 x 63	3/4" (19 mm) Can be reduced	125 - 150 mm (5-1/2" - 6")	T-63	HARRISON / COLCHESTER / CHIPMASTERS / BATAMSON or Similar lathes

Quick Change Tool Post C2 & C3 Mini Lathes



Item Code No.
ABM-IMT-6185

Quick Change Tool Post – C2 C3 Mini Lathes
 Quick Change Tool Post – C18A Series

- Speed up your mini lathe operations and enjoy the convenience of easy setup with this Quick Change Tool Post.
- Tool Capacity of the Standard Holder is 10 mm.
- Through Bore in the block is 10 mm.
- Quick Change Tool post with 3 Standard Holders.
- Block Height 30 mm, Width 51 mm, Length with Holder attached 74 mm (50x50).
- Packed in Finished Wooden Box.

Quick Change Tool Post Dual Mounting - Set of 5 Pcs.



Item Code No.
ABM-IMT-6183

Quick Change Tool Post – Dual Mounting – Set of 5 Pcs.

- Speed up your mini lathe operations and enjoy the convenience of easy setup with this Quick Change Tool Post.
- Support Lathes for 4" (100 mm) Center Height Lathes.
- Packed in Finished Wooden Box.

SET CONTAINS
 Mounting Block – 1 No. (Block Dimension 62 x 88 x 39 mm)
 Standard Holder – 2 No. (Capacity 12 mm)
 Vee / Boring Holder of 12 mm Capacity – 2 No. (Capacity 12 mm)
 Two Spanner

Quick Change Tool Post

Single Mounting - Set of 3 Pcs.

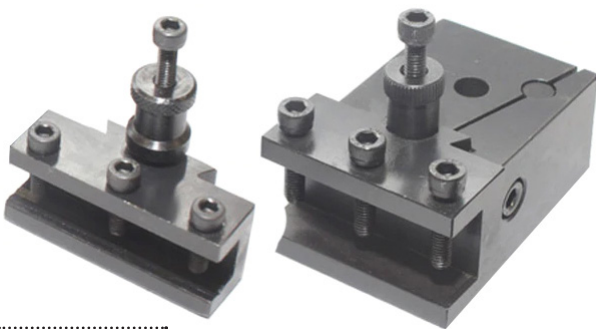

Item Code No.
ABM-IMT-6180

- Contains 2 holders 12 mm Capacity.
- Speed up your mini lathe operations and enjoy the convenience of easy setup with this Quick Change Tool Post.
- Mounting Bore 3/8" (10 mm).
- Support Lathes Height 90 mm.
- Packed in Finished Wooden Box.

SET CONTAINS
Mounting Block 1 No. (Block Dimension 58 x 58 x 32 mm)
Standard Holder 2 No. (Capacity 12 mm)
One Spanner

Quick Change Tool Post

T72 / T2 (5 Pcs Set)



- Useful tool post for quick changing.
- Comes with Spanner.
- Packed in finished Wooden Box.

SET CONTAINS (5 Pcs.)
Mounting Block Size 97 x 97 x 72 mm – 1 No.
Standard Holder Capacity 28 mm – 2 No.
Vee – Boring Holder Capacity 28 mm – 1 No.
Parting Holder Capacity 1/8" x 7/8" – 1 No.

Item Code No.	Block Dimension l x b x h - mm	Mounting Bore
ABM-IMT-6088	97 x 97 x 72	1" (25.4 mm)

Quick Change Tool Post

T2 Size - 3 Holders

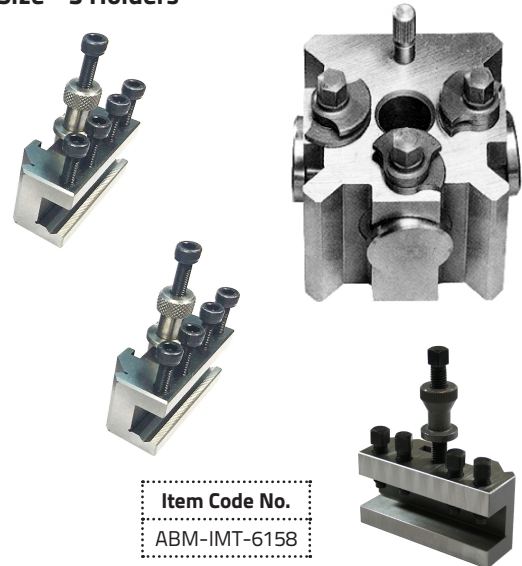

Item Code No.
ABM-IMT-6158

- Contains 3 holders 28 mm Capacity.
- Speed up your mini lathe operations and enjoy the convenience of easy setup with this Quick Change Tool Post.
- Mounting Bore 1" (25.4 mm).

SET CONTAINS
Mounting Block 1 No. (Block Dimension 97 x 97 x 72 mm)
Standard Holder 3 No. (Capacity 28 mm)
One Spanner

Quick Change Tool Post

3 Pcs Set

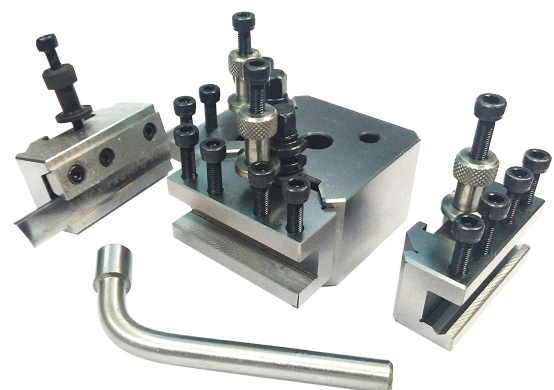

Item Code No.
ABM-IMT-6155

- Contains 2 holders small.
- Speed up your mini lathe operations and enjoy the convenience of easy setup with this Quick Change Tool Post.
- Comes with 3 Holders, One HSS Tool Bit 3/32 x 1/2 x 3-1/2 and two Hex Keys.

Quick Change Tool Post Economy

Starter Set (Set of 4 Pcs.)

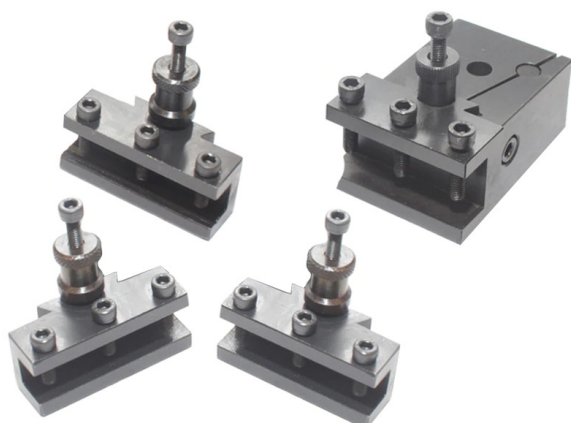

- Useful tool post for quick changing.
- Great for mini lathes.
- Hardened and tempered body.
- Comes with Allen keys.
- Standard Holders 1/2" Capacity – 3 Nos.
- Standard Holders 3/4" Capacity – 1 No.

Item Code No.	Size Inch l x b x h - Inches	Size Inch l x b x h - mm	Mounting Bore
ABM-IMT-6720	2-3/8 x 2-1/4 x 1-1/4	60 x 55 x 30	3/8"

Boring Holders

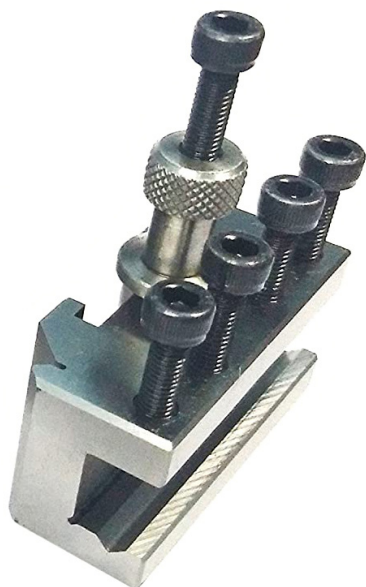

Item Code No.	Capacity mm	Suitable for
ABM-IMT-6090	13	T 37
ABM-IMT-6091	16	T 51
ABM-IMT-6092	22	T 63
ABM-IMT-6093	28	T 72 / T2

Standard Holders

Turning Tool Holders



Item Code No.	Capacity mm	Suitable for
ABM-IMT-6145	13	T 37
ABM-IMT-6146	16	T 51
ABM-IMT-6147	22	T 63
ABM-IMT-6148	28	T 72 / T2

Parting Tool Holders



Item Code No.	Capacity inches	Suitable for
ABM-IMT-6095	3/32 x 1/2	T 37
ABM-IMT-6096	1/8 x 3/4	T 51
ABM-IMT-6097	1/8 x 3/4	T 63
ABM-IMT-6098	1/8 x 7/8	T 72 / T2

Rocking Tool Posts

- These rocker tool posts are great for grabbing a little extra rake angle and for working in tight or hard to reach places.
- Rocker tool posts hold a single toolholder or cutting bit and the center height for cutting can be adjusted without shims.

Item Code No.	Description
ABM-IMT-6730	Rocker Tool Post - Small Tool Holder with 3/8" x 1-1/2" Shank
ABM-IMT-6731	Rocker Tool Post - Medium for Tool Holder with 3/4" x 1" Shank
ABM-IMT-6732	Rocker Tool Post - Big for Tool Holder with 3/4" x 1-3/4" Shank



Precision Boring Head Kit 75 mm / 3" - BT Shank

- Machined from High grade steel with tool blocks hardened and ground.
- Allows easy reading and adjustment.
- Threaded back for interchangeable Shanks.
- Ideal for Mill or Jig Bore Operations.
- Very versatile and useful in any machine shop floor.
- The construction of the head is so designed that it is very useful for making heavy roughing cuts as well as more accurate finishing cuts.
- Rigid designs and threaded interchangeable shanks for the boring head make it useful for machines with different tapers.



Boring Heads have three major components:

1. Boring head body
2. Bar holder/insert holder
3. Dial screw

Boring Heads Kits 75 mm / 3" Consist of :

1. 75 mm / 3" Boring Head – 1 No.
2. BT Shank – 1 No.
3. Fly Cutter – 1 No.
4. 5 Pcs Set 20 mm (HSS Boring Tool Assorted Sizes or Carbide Brazed Boring Tools) – 1 Pc.

HSS

Carbide Brazed

Packed in attractive Wooden box Packing

Item Code No.	Shank	Description
ABM-IMT-3170	BT 30	Kit with HSS Boring Tool
ABM-IMT-3171	BT 30	Kit with Carbide Brazed Tool
ABM-IMT-3172	BT 40	Kit with HSS Boring Tool
ABM-IMT-3173	BT 40	Kit with Carbide Brazed Tool
ABM-IMT-3174	BT 50	Kit with HSS Boring Tool
ABM-IMT-3175	BT 50	Kit with Carbide Brazed Tool

Precision Boring Head Kit 75 mm / 3" - ISO Shank

- Machined from High grade steel with tool blocks hardened and ground.
- Allows easy reading and adjustment.
- Threaded back for interchangeable Shanks.
- Ideal for Mill or Jig Bore Operations.
- Very versatile and useful in any machine shop floor.
- The construction of the head is so designed that it is very useful for making heavy roughing cuts as well as more accurate finishing cuts.
- Rigid designs and threaded interchangeable shanks for the boring head make it useful for machines with different tapers.

Boring Heads have three major components:

1. Boring head body
2. Bar holder/insert holder
3. Dial screw

Boring Heads Kits 75 mm / 3" Consist of :

1. 75 mm / 3" Boring Head – 1 No.
2. ISO Shank – 1 No.
3. Fly Cutter – 1 No.
4. 5 Pcs Set 20 mm (HSS Boring Tool Assorted Sizes or Carbide Brazed Boring Tools) – 1 Pc.

Packed in attractive Wooden box Packing

Item Code No.	Shank	Description
ABM-IMT-3160	ISO 30	Kit with HSS Boring Tool
ABM-IMT-3161	ISO 30	Kit with Carbide Brazed Tool
ABM-IMT-3162	ISO 40	Kit with HSS Boring Tool
ABM-IMT-3163	ISO 40	Kit with Carbide Brazed Tool
ABM-IMT-3164	ISO 50	Kit with HSS Boring Tool
ABM-IMT-3165	ISO 50	Kit with Carbide Brazed Tool



Precision Boring Head Kit 75 mm / 3" - MT Shank

- Machined from High grade steel with tool blocks hardened and ground.
- Allows easy reading and adjustment.
- Threaded back for interchangeable Shanks.
- Ideal for Mill or Jig Bore Operations.
- Very versatile and useful in any machine shop floor.
- The construction of the head is so designed that it is very useful for making heavy roughing cuts as well as more accurate finishing cuts.
- Rigid designs and threaded interchangeable shanks for the boring head make it useful for machines with different tapers.

Machine Tools Accessories



Machine Tools Accessories

Machine Tools Accessories

Machine Tools Accessories

Machine Tools Accessories

Boring Heads have three major components:

1. Boring head body
2. Bar holder/insert holder
3. Dial screw

Boring Heads Kits 75 mm / 3" Consist of :

1. 75 mm / 3" Boring Head – 1 No.
2. MT Shank – 1 No.
3. 5 Pcs Set 20 mm (HSS Boring Tool Assorted Sizes or Carbide Brazed Boring Tools) – 1 Pc.



HSS

Packed in attractive Wooden box Packing

Item Code No. Metric	Item Code No. Inches	Styles	Description
ABM-IMT-3145	ABM-IMT-3151	MT 2	Kit with HSS Boring Tool
ABM-IMT-3146	ABM-IMT-3152	MT 2	Kit with Carbide Brazed Tool
ABM-IMT-3147	ABM-IMT-3153	MT 3	Kit with HSS Boring Tool
ABM-IMT-3148	ABM-IMT-3154	MT 3	Kit with Carbide Brazed Tool
ABM-IMT-3149	ABM-IMT-3155	MT 4	Kit with HSS Boring Tool
ABM-IMT-3150	ABM-IMT-3156	MT 4	Kit with Carbide Brazed Tool



Carbide Brazed

Precision Boring Head Kit 75 mm / 3" - R8 Shank

- Machined from High grade steel with tool blocks hardened and ground.
- Allows easy reading and adjustment.
- Threaded back for interchangeable Shanks.
- Ideal for Mill or Jig Bore Operations.
- Very versatile and useful in any machine shop floor.
- The construction of the head is so designed that it is very useful for making heavy roughing cuts as well as more accurate finishing cuts.
- Rigid designs and threaded interchangeable shanks for the boring head make it useful for machines with different tapers.

Boring Heads have three major components:

1. Boring head body
2. Bar holder/insert holder
3. Dial screw

Boring Heads Kits 75 mm / 3" Consist of :

1. 75 mm / 3" Boring Head – 1 No.
2. R8 Shank – 1 No.
3. 5 Pcs Set 20 mm (HSS Boring Tool Assorted Sizes or Carbide Brazed Boring Tools) – 1 Pc.

Packed in attractive Wooden box Packing



HSS

Carbide Brazed

Item Code No.	Description
ABM-IMT-3140	Kit with HSS Boring Tool
ABM-IMT-3141	Kit with Carbide Brazed Tool

Precision Boring Head Kit 62 mm

- Machined from High grade steel with tool blocks hardened and ground.
- Allows easy reading and adjustment.
- Threaded back for interchangeable Shanks.
- Ideal for Mill or Jig Bore Operations.
- Very versatile and useful in any machine shop floor.
- The construction of the head is so designed that it is very useful for making heavy roughing cuts as well as ore accurate finishing cuts.
- Rigid designs and threaded interchangeable shanks for the boring head make it useful for machines with different tapers.

Boring Heads have three major components:

1. Boring head body
2. Bar holder/insert holder
3. Dial screw

Boring Heads Kits 62 mm Consist of :

1. 62 mm Boring Head – 1 No.
2. Shank R8 or MT2 or MT3 or MT4 or ISO 30 or ISO 40 or ISO 50 or BT 30 or BT 40 or BT 50 – 1 No.
3. 12 mm (HSS Boring Tool Assorted Sizes or Carbide Brazed Boring Tools) – 1 Pc.
4. LN Keys – 2 Nos.
5. Fly Cutter 45 Degree for 6 mm Round Tool Bit – 1 Nos.

Packed in attractive Wooden box Packing

Item Code No.	Shank
ABM-IMT-3125	R 8
ABM-IMT-3126	MT 2
ABM-IMT-3127	MT 3
ABM-IMT-3128	MT 4
ABM-IMT-3129	ISO 30
ABM-IMT-3130	ISO 40
ABM-IMT-3131	ISO 50
ABM-IMT-3132	BT 30
ABM-IMT-3133	BT 40
ABM-IMT-3134	BT 50

While Placing order please mention
with HSS Boring Tool or Carbide Brazed Boring Tools



Precision Boring Head Kit 50 mm / 2" - BT Shank

- Machined from High grade steel with tool blocks hardened and ground.
- Allows easy reading and adjustment.
- Threaded back for interchangeable Shanks.
- Ideal for Mill or Jig Bore Operations.
- Very versatile and useful in any machine shop floor.
- The construction of the head is so designed that it is very useful for making heavy roughing cuts as well as more accurate finishing cuts.



- Rigid designs and threaded interchangeable shanks for the boring head make it useful for machines with different tapers.

Boring Heads have three major components:

1. Boring head body
2. Bar holder/insert holder
3. Dial screw

Boring Heads Kits 50 mm / 2" Consist of :

1. 50 mm / 2" Boring Head – 1 No.
2. BT Shank – 1 No.
3. 5 Pcs Set. – 12 mm (HSS Boring Tool Assorted Sizes or Carbide Brazed Boring Tools) – 1 Set.
4. LN Keys – 2 Nos.
5. Fly Cutter 45 Degree for 8 mm Round Tool Bit – 1 Nos.

Packed in attractive Wooden box Packing

Item Code No.	Shank	Description
ABM-IMT-3115	BT 30	Kit with HSS Boring Tool
ABM-IMT-3116	BT 30	Kit with Carbide Brazed Tool
ABM-IMT-3117	BT 40	Kit with HSS Boring Tool
ABM-IMT-3118	BT 40	Kit with Carbide Brazed Tool
ABM-IMT-3119	BT 50	Kit with HSS Boring Tool
ABM-IMT-3120	BT 50	Kit with Carbide Brazed Tool



Precision Boring Head Kit 50 mm / 2" - ISO Shank

- Machined from High grade steel with tool blocks hardened and ground.
- Allows easy reading and adjustment.
- Threaded back for interchangeable Shanks.
- Ideal for Mill or Jig Bore Operations.
- Very versatile and useful in any machine shop floor.
- The construction of the head is so designed that it is very useful for making heavy roughing cuts as well as more accurate finishing cuts.
- Rigid designs and threaded interchangeable shanks for the boring head make it useful for machines with different tapers.

Boring Heads have three major components:

1. Boring head body
2. Bar holder/insert holder
3. Dial screw

Boring Heads Kits 50 mm / 2" Consist of :

1. 50mm / 2" Boring Head – 1 No.
2. ISO Shank – 1 No.
3. 5 Pcs Set. – 12mm (HSS Boring Tool Assorted Sizes or Carbide Brazed Boring Tools) – 1 Set.
4. LN Keys – 2 Nos.
5. Fly Cutter 45 Degree for 8 mm Round Tool Bit – 1 Nos.



Packed in attractive Wooden box Packing

Item Code No.	Boring Head Size	Description	Shank	Shank Drawbar
ABM-IMT-3109	50 mm	Kit with 12 mm HSS Boring Tool	ISO 30	M 12
ABM-IMT-3110	50 mm	Kit with 12 mm Carbide Brazed Tool	ISO 30	M 12
ABM-IMT-3111	50 mm	Kit with 12 mm HSS Boring Tool	ISO 40	M 16
ABM-IMT-3112	50 mm	Kit with 12 mm Carbide Brazed Tool	ISO 40	M 16
ABM-IMT-3113	50 mm	Kit with 12 mm HSS Boring Tool	ISO 50	M 24
ABM-IMT-3114	50 mm	Kit with 12 mm Carbide Brazed Tool	ISO 50	M 24

Precision Boring Head Kit 50 mm / 2" - MT Shank

- Machined from High grade steel with tool blocks hardened and ground.
- Allows easy reading and adjustment.
- Threaded back for interchangeable Shanks.
- Ideal for Mill or Jig Bore Operations.
- Very versatile and useful in any machine shop floor.
- The construction of the head is so designed that it is very useful for making heavy roughing cuts as well as more accurate finishing cuts.
- Rigid designs and threaded interchangeable shanks for the boring head make it useful for machines with different tapers.

Boring Heads have three major components:

1. Boring head body
2. Bar holder/insert holder
3. Dial screw



HSS

Carbide Brazed

Boring Heads Kits 50 mm / 2" Consist of :

1. 50 mm / 2" Boring Head – 1 No.
2. MT 2 Shank or MT 3 Shank – 1 No.
3. 5 Pcs Set. – 12 mm (HSS Boring Tool Assorted Sizes or Carbide Brazed Boring Tools) – 1 Set.
4. LN Keys – 2 Nos.
5. Fly Cutter 45 Degree for 8 mm Round Tool Bit – 1 Nos.

Packed in attractive Wooden box Packing

Item Code No. Metric	Item Code No. Inches	Styles	Description
ABM-IMT-3090	ABM-IMT-3098	MT 1	Kit with 12 mm HSS Boring Tool
ABM-IMT-3091	ABM-IMT-3099	MT 1	Kit with 12 mm Carbide Brazed Tool
ABM-IMT-3092	ABM-IMT-3100	MT 2	Kit with 12 mm HSS Boring Tool
ABM-IMT-3093	ABM-IMT-3101	MT 2	Kit with 12 mm Carbide Brazed Tool
ABM-IMT-3094	ABM-IMT-3102	MT 3	Kit with 12 mm HSS Boring Tool
ABM-IMT-3095	ABM-IMT-3103	MT 3	Kit with 12 mm Carbide Brazed Tool
ABM-IMT-3096	ABM-IMT-3104	MT 4	Kit with 12 mm HSS Boring Tool
ABM-IMT-3097	ABM-IMT-3105	MT 4	Kit with 12 mm Carbide Brazed Tool



Precision Boring Head Kit 50 mm / 2" - R8 Shank

- Machined from High grade steel with tool blocks hardened and ground.
- Allows easy reading and adjustment.
- Threaded back for interchangeable Shanks.
- Ideal for Mill or Jig Bore Operations.
- Very versatile and useful in any machine shop floor.
- The construction of the head is so designed that it is very useful for making heavy roughing cuts as well as more accurate finishing cuts.
- Rigid designs and threaded interchangeable shanks for the boring head make it useful for machines with different tapers.

Boring Heads have three major components:

1. Boring head body
2. Bar holder/insert holder
3. Dial screw



HSS

Carbide Brazed

Boring Heads Kits 50 mm / 2" Consist of :

1. 50 mm / 2" Boring Head – 1 No.
2. R8 Shank – 1 No.
3. 5 Pcs Set. – 12 mm (HSS Boring Tool Assorted Sizes or Carbide Brazed Boring Tools) – 1 Set.
4. LN Keys – 2 Nos.
5. Fly Cutter 45 Degree for 8 mm Round Tool Bit – 1 Nos.

Packed in attractive Wooden box Packing

Item Code No.	Styles	Description
ABM-IMT-3107	R8	Kit with 12 mm HSS Boring Tool
ABM-IMT-3108	R8	Kit with 12 mm Carbide Brazed Tool

Precision Boring Head Kit 50 mm / 2"

- Machined from High grade steel with tool blocks hardened and ground.
- Allows easy reading and adjustment.
- Threaded back for interchangeable Shanks.
- Ideal for Mill or Jig Bore Operations.
- Very versatile and useful in any machine shop floor.
- The construction of the head is so designed that it is very useful for making heavy roughing cuts as well as more accurate finishing cuts.
- Rigid designs and threaded interchangeable shanks for the boring head make it useful for machines with different tapers.

Boring Heads have three major components:

1. Boring head body
2. Bar holder/insert holder
3. Dial screw



R8

MT

HSS

Carbide Brazed

Boring Heads Kits 50 mm / 2" Consist of :

1. 50 mm / 2" Boring Head – 1 No.
2. MT 3 Shank or R8 Shank – 1 No.
3. 5 Pcs Set. – 12 mm (HSS Boring Tool Assorted Sizes or Carbide Brazed Boring Tools) – 1 Set.
4. LN Keys – 2 Nos.

Packed in attractive Wooden box Packing

Item Code No.	Description	Shank
ABM-IMT-3080	Kit with 12 mm HSS Boring Tool	MT 3
ABM-IMT-3081	Kit with 12 mm Carbide Brazed Tool	MT 3
ABM-IMT-3082	Kit with 12 mm HSS Boring Tool	R 8
ABM-IMT-3083	Kit with 12 mm Carbide Brazed Tool	R 8

Boring Head Kit 50 mm / 2" - With Shanks

- Machined from High grade steel with tool blocks hardened and ground.
- Allows easy reading and adjustment.
- Threaded back for interchangeable Shanks.
- Ideal for Mill or Jig Bore Operations.
- Very versatile and useful in any machine shop floor.
- The construction of the head is so designed that it is very useful for making heavy roughing cuts as well as more accurate finishing cuts.
- Rigid designs and threaded interchangeable shanks for the boring head make it useful for machines with different tapers.

Boring Heads have three major components:

1. Boring head body
2. Bar holder/insert holder
3. Dial screw

Item Code No. Metric	Styles	Description
ABM-IMT-3070	MT 2	Boring Head + MT 2 Shank
ABM-IMT-3071	MT 3	Boring Head + MT 3 Shank
ABM-IMT-3072	R 8	Boring Head + R 8 Shank
ABM-IMT-3073	ISO 30	Boring Head + ISO 30 Shank
ABM-IMT-3074	ISO 40	Boring Head + ISO 40 Shank



Precision Boring Head Kit 38 mm - MT + Straight Shank

- Machined from High grade steel with tool blocks hardened and ground.
- Allows easy reading and adjustment.
- Threaded back for interchangeable Shanks.
- Ideal for Mill or Jig Bore Operations.
- Very versatile and useful in any machine shop floor.



- The construction of the head is so designed that it is very useful for making heavy roughing cuts as well as more accurate finishing cuts.
- Rigid designs and threaded interchangeable shanks for the boring head make it useful for machines with different tapers.

Boring Heads have three major components:

1. Boring head body
2. Bar holder/insert holder
3. Dial screw

Boring Heads Kits 38 mm Consist of :

1. 38 mm Boring Head – 1 No.
2. MT 2 Shank – 1 No.
3. Straight Shank – 1 No.
4. MT 3 Shank – 1 No.
5. Fly Cutter 45 Angle to hold 8 mm Round HSS Tool Bits – 1 No.
6. 5 Pcs Set. – 8mm (HSS Boring Tool Assorted Sizes or Carbide Brazed Boring Tools) – 1 Set.
7. LN Keys – 2 Nos.



HSS



Carbide Brazed

Item Code No.	Style	Contents
ABM-IMT-3055	MT 2 Shank MT 3 Shank 12 mm Straight Shank	Kit with 8 mm HSS Boring Tools
ABM-IMT-3056	MT 2 Shank MT 3 Shank 12 mm Straight Shank	Kit with 8 mm Carbide Brazed Boring Tools

Precision Boring Head Kit 38 mm - MT Shank

- Machined from High grade steel with tool blocks hardened and ground.
- Allows easy reading and adjustment.
- Threaded back for interchangeable Shanks.
- Ideal for Mill or Jig Bore Operations.
- Very versatile and useful in any machine shop floor.
- The construction of the head is so designed that it is very useful for making heavy roughing cuts as well as more accurate finishing cuts.
- Rigid designs and threaded interchangeable shanks for the boring head make it useful for machines with different tapers.

Boring Heads have three major components:

1. Boring head body
2. Bar holder/insert holder
3. Dial screw



HSS



Carbide Brazed

Boring Heads Kits 38 mm Consist of :

1. 38 mm Boring Head – 1 No.
2. MT 2 Shank – 1 No.
3. Fly Cutter 45 Angle to hold 8 mm Round HSS Tool Bits – 1 No.
4. 5 Pcs Set. – 8 mm (HSS Boring Tool Assorted Sizes or Carbide Brazed Boring Tools) – 1 Set.
5. LN Keys – 2 Nos.

Packed in attractive Wooden box Packing

Item Code No.	Style	Contents
ABM-IMT-3050	MT 2 Shank	Kit with 8 mm HSS Boring Tools
ABM-IMT-3051	MT 2 Shank	Kit with 8 mm Carbide Brazed Boring Tools

Precision Boring Head Kit 38 mm - Straight Shank

- Machined from High grade steel with tool blocks hardened and ground.
- Allows easy reading and adjustment.
- Threaded back for interchangeable Shanks.
- Ideal for Mill or Jig Bore Operations.
- Very versatile and useful in any machine shop floor.
- The construction of the head is so designed that it is very useful for making heavy roughing cuts as well as more accurate finishing cuts.
- Rigid designs and threaded interchangeable shanks for the boring head make it useful for machines with different tapers.

Boring Heads have three major components:

1. Boring head body
2. Bar holder/insert holder
3. Dial screw



HSS

Carbide Brazed

Boring Heads Kits 38 mm Consist of :

1. 38 mm Boring Head – 1 No.
2. 12 mm Straight Shank – 1 No.
3. Fly Cutter 45 Angle to hold 5 mm & 8 mm Round HSS Tool Bits – 1 No.
4. 5 Pcs Set. – 8 mm (HSS Boring Tool Assorted Sizes or Carbide Brazed Boring Tools) – 1 Set.
5. LN Keys – 2 Nos.

Packed in attractive Wooden box Packing

Item Code No.	Style	Contents
ABM-IMT-3045	12 mm Straight Shank	Kit with 8 mm HSS Boring Tools
ABM-IMT-3046	12 mm Straight Shank	Kit with 8 mm Carbide Brazed Boring Tools



Precision Boring Head Kit 38 mm - Straight Shank

- Machined from High grade steel with tool blocks hardened and ground.
- Allows easy reading and adjustment.
- Threaded back for interchangeable Shanks.
- Ideal for Mill or Jig Bore Operations.
- Very versatile and useful in any machine shop floor.
- The construction of the head is so designed that it is very useful for making heavy roughing cuts as well as more accurate finishing cuts.
- Rigid designs and threaded interchangeable shanks for the boring head make it useful for machines with different tapers.



Boring Heads have three major components:

1. Boring head body
2. Bar holder/insert holder
3. Dial screw

Boring Heads Kits 38 mm Consist of :

1. 38 mm Boring Head – 1 No.
2. 12 mm Straight Shank – 1 No.
3. MT 2 Shank – 1 No.
4. MT 3 Shank – 1 No.
5. Fly Cutter 45 Angle to hold 5 mm & 8 mm Round HSS Tool Bits – 1 No.
6. 5 mm & 8 mm Round Tool Bits – 1 No.
7. Straight Shank – 1 No.
8. 3 Pcs Set. – 8 mm (HSS Boring Tool Assorted Sizes or Carbide Brazed Boring Tools) – 1 Set.
9. LN Keys – 2 Nos.



HSS



Carbide Brazed

Packed in attractive Wooden box Packing



Round Tool Bit

Item Code No.	Contents
ABM-IMT-3037	Kit with 8 mm HSS Boring Tools
ABM-IMT-3038	Kit with 8 mm Carbide Brazed Boring Tools

Boring Head 38 mm with Shanks

- Machined from High grade steel with tool blocks hardened and ground.
- Allows easy reading and adjustment.
- Threaded back for interchangeable Shanks.
- Ideal for Mill or Jig Bore Operations.
- Very versatile and useful in any machine shop floor.
- The construction of the head is so designed that it is very useful for making heavy roughing cuts as well as more accurate finishing cuts.
- Rigid designs and threaded interchangeable shanks for the boring head make it useful for machines with different tapers.

Boring Heads have three major components:

1. Boring head body
2. Bar holder/insert holder
3. Dial screw



Item Code No.	Style	Contents
ABM-IMT-3030	12 mm	Boring Head + 12 mm Straight Shank
ABM-IMT-3031	MT 2	Boring Head + MT 2 Shank
ABM-IMT-3032	MT 3	Boring Head + MT 3 Shank
ABM-IMT-3033	R 8	Boring Head + R 8 Shank

Precision Boring Head Kit 30 mm - MT Shank + Straight Shank

- Machined from High grade steel with tool blocks hardened and ground.
- Allows easy reading and adjustment.
- Threaded back for interchangeable Shanks.
- Ideal for Mill or Jig Bore Operations.
- Very versatile and useful in any machine shop floor.
- The construction of the head is so designed that it is very useful for making heavy roughing cuts as well as more accurate finishing cuts.
- Rigid designs and threaded interchangeable shanks for the boring head make it useful for machines with different tapers.



Boring Heads have three major components:

1. Boring head body
2. Bar holder/insert holder
3. Dial screw



HSS

Carbide Brazed

Boring Heads Kits 30 mm Consist of :

1. 30 mm Boring Head – 1 No.
2. MT 2 Shank – 1 No.
3. Straight Shank – 1 No.
4. 5 Pcs Set. – 6 mm (HSS Boring Tool Assorted Sizes or Carbide Brazed Boring Tools) – 1 Set.
5. Fly Cutter 45 Degree for 6 mm Round Tool – 1 No.

Packed in attractive Wooden box Packing

Item Code No.	Contents
ABM-IMT-3025	Kit with 6 mm HSS Boring Tools
ABM-IMT-3026	Kit with 6 mm Carbide Brazed Boring Tools



Precision Boring Head Kit 30 mm - MT Shank

- Machined from High grade steel with tool blocks hardened and ground.
- Allows easy reading and adjustment.
- Threaded back for interchangeable Shanks.
- Ideal for Mill or Jig Bore Operations.
- Very versatile and useful in any machine shop floor.
- The construction of the head is so designed that it is very useful for making heavy roughing cuts as well as more accurate finishing cuts.
- Rigid designs and threaded interchangeable shanks for the boring head make it useful for machines with different tapers.

Boring Heads have three major components:

1. Boring head body
2. Bar holder/insert holder
3. Dial screw



HSS

Carbide Brazed

Boring Heads Kits 30 mm Consist of :

1. 30 mm Boring Head – 1 No.
2. MT 2 Shank – 1 No.
3. 5 Pcs Set. – 6 mm (HSS Boring Tool Assorted Sizes or Carbide Brazed Boring Tools) – 1 Set.
4. Fly Cutter 45 Degree for 6 mm Round Tool – 1 No.

Packed in attractive Wooden box Packing

Item Code No.	Contents
ABM-IMT-3020	Kit with 6 mm HSS Boring Tools
ABM-IMT-3021	Kit with 6 mm Carbide Brazed Boring Tools

Precision Boring Head Kit 30 mm - Straight Shank

- Machined from High grade steel with tool blocks hardened and ground.
- Allows easy reading and adjustment.
- Threaded back for interchangeable Shanks.
- Ideal for Mill or Jig Bore Operations.
- Very versatile and useful in any machine shop floor.
- The construction of the head is so designed that it is very useful for making heavy roughing cuts as well as more accurate finishing cuts.
- Rigid designs and threaded interchangeable shanks for the boring head make it useful for machines with different tapers.

Boring Heads have three major components:

1. Boring head body
2. Bar holder/insert holder
3. Dial screw



HSS

Carbide Brazed

Boring Heads Kits 30 mm Consist of :

1. 30 mm Boring Head – 1 No.
2. 12 mm Straight Shank – 1 No.
3. 5 Pcs Set. – 6 mm (HSS Boring Tool Assorted Sizes or Carbide Brazed Boring Tools) – 1 Set.
4. Fly Cutter 45 Degree for 6 mm Round Tool – 1 No.

Packed in attractive Wooden box Packing

Item Code No.	Contents
ABM-IMT-3015	Kit with 6 mm HSS Boring Tools
ABM-IMT-3016	Kit with 6 mm Carbide Brazed Boring Tools

Precision Boring Head Kit 30 mm

- Machined from High grade steel with tool blocks hardened and ground.
- Allows easy reading and adjustment.
- Threaded back for interchangeable Shanks.
- Ideal for Mill or Jig Bore Operations.
- Very versatile and useful in any machine shop floor.
- The construction of the head is so designed that it is very useful for making heavy roughing cuts as well as more accurate finishing cuts.
- Rigid designs and threaded interchangeable shanks for the boring head make it useful for machines with different tapers.

Boring Heads have three major components:

1. Boring head body
2. Bar holder/insert holder
3. Dial screw

Boring Heads Kits 30 mm Consist of :

1. 30 mm Boring Head – 1 No.
2. 12 mm Straight Shank – 1 No.
3. MT-2 Shank – 1 No.
4. 8 Pcs Set. – 6 mm (HSS Boring Tool Assorted Sizes or Carbide Brazed Boring Tools) – 1 Set.
5. LN Keys – 2 Nos.

Packed in attractive Wooden box Packing

Item Code No.	Contents
ABM-IMT-3007	Kit with 6 mm HSS Boring Tools
ABM-IMT-3008	Kit with 6 mm Carbide Brazed Boring Tools





Boring Head With Shanks 30 mm

- Machined from High grade steel with tool blocks hardened and ground.
- Allows easy reading and adjustment.
- Threaded back for interchangeable Shanks.
- Ideal for Mill or Jig Bore Operations.
- Very versatile and useful in any machine shop floor.
- The construction of the head is so designed that it is very useful for making heavy roughing cuts as well as more accurate finishing cuts.
- Rigid designs and threaded interchangeable shanks for the boring head make it useful for machines with different tapers.

Boring Heads have three major components:

1. Boring head body
2. Bar holder/insert holder
3. Dial screw



Item Code No.	Style	Contents
ABM-IMT-3000	12 mm	Boring Head + 12 mm Straight Shank
ABM-IMT-3001	MT 2	Boring Head + MT 2 Shank
ABM-IMT-3002	MT 3	Boring Head + MT 3 Shank
ABM-IMT-3003	R 8	Boring Head + R 8 Shank

Shanks for Mini Boring Heads

- The boring head shank adapts our boring head to the mini mill with a Morse taper spindle.
- Fits all heads with threaded back. Taper shanks are mounted directly to the machine spindle.

Item Code No.	Style	Draw Bar	Mounting Thread	Suitable for Boring Head
ABM-IMT-4920	12 mm	--	M 14 x 1.0	30 & 38 mm
ABM-IMT-4921	MT 1	MT 6	M 14 x 1.0	30 & 38 mm
ABM-IMT-4922	MT 2	MT 10	M 14 x 1.0	30 & 38 mm
ABM-IMT-4923	MT 3	MT 12	M 14 x 1.0	30 & 38 mm



Mini Boring Heads

- Machined from High grade steel with tool blocks hardened and ground.
- Non-Reflecting Satin Chrome Body allows easy reading and adjustment.
- Threaded back for interchangeable Shanks.
- Ideal for Mill or Jig Bore Operations.
- Very versatile and useful in any machine shop floor.
- The construction of the head is so designed that it is very useful for making heavy roughing cuts as well as more accurate finishing cuts.
- Rigid designs and threaded interchangeable shanks for the boring head make it useful for machines with different tapers.



Boring Heads have three major components:

1. Boring head body
2. Bar holder/insert holder
3. Dial screw

Item Code No.	ABM-IMT-4795	ABM-IMT-4796
Head Dia. mm	30	38
Mounting Thread	M14 x 1.0	M14 x 1.0
Boring Tool Dia. mm	6	8
Center Dist. B/W Holes mm	9	11
Min Bore mm	6	8
Max Bore mm	45	60



Boring Heads With R8 Integrated Shanks

- Integrated Shank for maximum rigidity.
- Hardened and Ground Body.
- This Boring Head has a single piece rugged construction for a smooth and chatterless operations
- Hardened slide with a black oxide finish.
- Available in R8 and straight shanks.

Boring Heads have three major components:

1. Boring head body
2. Bar holder/insert holder
3. Dial screw

Item Code No.	ABM-IMT-4790	ABM-IMT-4791
Head Dia.	50 mm	2-1/2"
Overall Length	165 mm	7-3/16"
Draw Bar Thread	7/16" x 20 UNF	7/16" x 20 UNF
Max. Off Set	20 mm	3/4"
Center Distance B/W Holes	16 mm	5/8"
Crowd Vertica Hole Size	12 mm	1/2"
Min Bore	3/4"	3/4"
Max Bore	5"	5"
Shank	R8	R8



Precision Boring Heads

- Machined from High grade steel with tool blocks hardened and ground.
- Non-Reflecting Satin Chrome Body allows easy reading and adjustment.
- Threaded back for interchangeable Shanks.
- Ideal for Mill or Jig Bore Operations.
- Inch Features .0005" and Metric features 0.2 mm least count (Boring dia. double of least count).
- Very versatile and useful in any machine shopfloor.
- The construction of the head is so designed that it is very useful for making heavy roughing cuts as well as more accurate finishing cuts.
- Rigid designs and threaded interchangeable shanks for the boring head make it useful for machines with different tapers.
- Available in Metric and Inch Sizes.



Boring Heads have three major components:

1. Boring head body
2. Bar holder/insert holder
3. Dial screw

Item Code No. Metric Sizes	Head Dia. mm	Mounting Thread	Boring Tool Dia. mm	Centre Distance Between Holes	Min Bore mm	Max Bore mm
ABM-IMT-4800	30	M 14 x 1.0	6	9	6	45
ABM-IMT-4801	38	M 14 x 1.0	8	11	8	60
ABM-IMT-4802	50	1-1/2" x 18 TPI	12	16	10	100
ABM-IMT-4803	75	1-1/2" x 18 TPI	20	24	10	220
ABM-IMT-4804	100	1-1/2" x 18 TPI	25	25	10	250

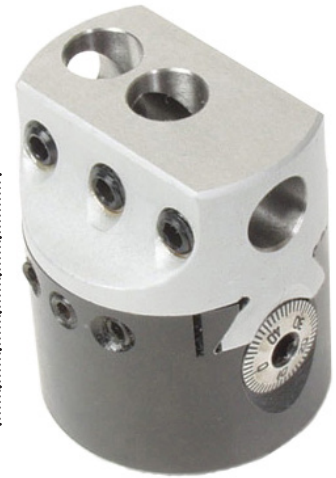

Item Code No. Imperial Sizes	Head Dia.	Mounting Thread	Boring Tool Dia.	Centre Distance Between Holes	Min Bore	Max Bore
ABM-IMT-4808	2"	7/8" x 20 UNF	1/2"	3/8"	3/8"	4"
ABM-IMT-4809	2"	1-1/2" x 18 TPI	1/2"	3/8"	3/8"	4"
ABM-IMT-4810	3"	1-1/2" x 18 TPI	3/4"	15/16"	3/8"	9"
ABM-IMT-4811	4"	1-1/2" x 18 TPI	1"	1"	3/8"	10"

Indexable Boring Head

- Supplied with suitable CCMT carbide insert, screw & Torx Key.
- Very useful for precision jobs.
- Inserts are replaceable.
- Spare Accessories available on request.
- Carbide insert provides chatter free and fine finished cuts with precision.
- Various Shanks also available separately.



Item Code No.	Head Diameter	Overall Length	Mounted Thread
ABM-IMT-4860	30 mm	40 mm	M 14 x 1.0
ABM-IMT-4861	35 mm	45 mm	M 14 x 1.0
ABM-IMT-4862	50 mm	60 mm	1-1/2" x 18 TPI

Boring Head Pivot Type

- Boring Head with Tool Holder Swing through 90°.
- Graduated dial 0.001" (0.02 mm).
- Can be used with Mt2, MT3 or R8 Shanks.
- Positive Side Lock.
- Boring Bar Hole Size 10 mm.
- Minimum Bore – 8 mm.
- Maximum Bore – 10 mm.
- Overall Length – 53 mm.
- Mounting Thread – M 16.
- Slide Travel 3/4" (19 mm).



Item Code No.	Shank	Contents
ABM-IMT-4880	MT 2	Boring Head + Shank + Fly Cutter
ABM-IMT-4881	MT 3	Boring Head + Shank + Fly Cutter
ABM-IMT-4882	MT 2 + MT 3	Boring Head + Shank + Fly Cutter

Boring Head Sets

Carbide



Cobalt

- Machined from high grade steel with Tool blocks hardened and ground.
- Ideal for mill or jig bore operations.
- Non-Reflecting Satin Chrome Body allows easy reading and adjustment.
- Threaded back for interchangeable Shanks.
- Inch Features .0005" and Metric features 0.2 mm least count (Boring dia. double of least count).

Cobalt Item Code No.	Sets Consists of
ABM-IMT-4865	Boring Head 2" (7/8" x 20) with R-8 Shank and 10 Pcs. 1/2" Cobalt Boring Bar Set
ABM-IMT-4866	Boring Head 2" (1-1/2" x 18) with R-8 Shank and 10 Pcs. 1/2" Cobalt Boring Bar Set
ABM-IMT-4867	Boring Head 2" (7/8" x 20) with 3/4" Shank and 10 Pcs. 1/2" Cobalt Boring Bar Set
ABM-IMT-4868	Boring Head 2" (1-1/2" x 18) with 3/4" Shank and 10 Pcs. 1/2" Cobalt Boring Bar Set
ABM-IMT-4869	Boring Head 3" (1-1/2" x 18) with R-8 Shank and 14 Pcs. 3/4" Cobalt Boring Bar Set
ABM-IMT-4870	Boring Head 3" (1-1/2" x 18) with 1" Shank and 14 Pcs. 3/4" Cobalt Boring Bar Set

Carbide Item Code No.	Sets Consists of
ABM-IMT-4871	Boring Head 2" (7/8" x 20) with R-8 Shank and 9 Pcs. 1/2" Carbide Boring Bar Set
ABM-IMT-4872	Boring Head 2" (1-1/2" x 18) with R-8 Shank and 9 Pcs. 1/2" Carbide Boring Bar Set
ABM-IMT-4873	Boring Head 2" (7/8" x 20) with 3/4" Shank and 9 Pcs. 1/2" Carbide Boring Bar Set
ABM-IMT-4874	Boring Head 2" (1-1/2" x 18) with 3/4" Shank and 9 Pcs. 1/2" Carbide Boring Bar Set
ABM-IMT-4875	Boring Head 3" (1-1/2" x 18) with R-8 Shank and 12 Pcs. 3/4" Carbide Boring Bar Set
ABM-IMT-4876	Boring Head 3" (1-1/2" x 18) with 1" Shank and 12 Pcs. 3/4" Carbide Boring Bar Set

Extension Adapters

- Extended boring depths are possible with the use of these intermediate Adapter.
- They can be used independently or in combination, depending on the desired depth of bore.
- When used in combination, they achieve the same degree of rigidity as found in a solid bar.
- This is due to a 1/2 degree dish on the shoulder that allows full contact at the perimeter.

Item Code No.	A		B		C	D
	Inch	mm	Inch	mm		
ABM-IMT-4820	1	25	2	50	7/8 x 20	7/8 x 20
ABM-IMT-4821	1-3/8	35	2	50	7/8 x 20	7/8 x 20
ABM-IMT-4822	2	50	2	50	1-1/2 x 18	7/8 x 20
ABM-IMT-4823	3	75	2-1/2	62	1-1/2 x 18	1-1/2 x 18
ABM-IMT-4824	4	100	3	75	1-1/2 x 18	1-1/2 x 18

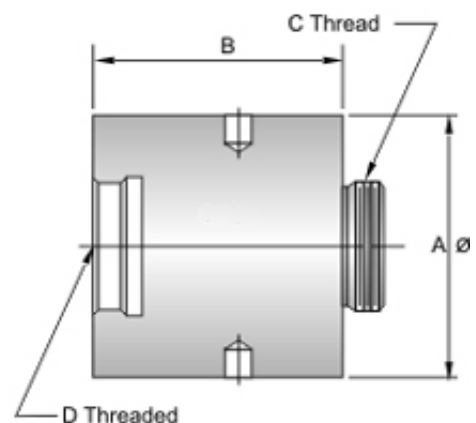

Micro Boring Head

- This boring head has an excellent wide base design and high quality ensuring long life and rigidity even when it is used in an offset position.
- The screw is hardened and ground which guarantees long life and trouble free use.
- An ideal product for mill or jig bore operations.
- interchangeable shanks of the heads make it adaptable for use on different machines.

Item Code no. ABM-IMT-4890

The complete set consists of the following

- Boring Head 62 mm.
- ISO40 Shank.
- 10 mm HSS Boring Tool.
- 10 mm Carbide Brazes Boring Tool.
- Fly Cutter 41 mm Overall Length. 45° Hole to Hold 6 mm HSS Round Tool Bit
- Fly Cutter 75 mm Overall Length. 45° Hole to Hold 6 mm HSS Round Tool Bit
- 2 Pc Hex Keys

Item Code no. ABM-IMT-4895

The complete set consists of the following

- Boring Head 80 mm.
- ISO40 Shank.
- 16 mm HSS Boring Tool.
- 16 mm Carbide Brazes Boring Tool.
- Fly Cutter 62 mm Overall Length. 45° Hole to Hold 6 mm HSS Round Tool Bit
- Fly Cutter 93 mm Overall Length. 45° Hole to Hold 8 mm HSS Round Tool Bit
- 2 Pc Hex Keys



Dimension in mm

Item Code No.	Boring Head Dia.	Overall Length	Boring Bar Hole	Centre Distance between Holes	Cross Hole Size	Slide Radial Travel	Min Bore	Max Bore	Mounting Thread
ABM-IMT-4890	62	52	10	24	10	22	10	85	16 x 1.5
ABM-IMT-4895	80	40	16	40	20	40	16	135	20 x 1.5

Automatic Boring Cum Facing Heads

- Automatic Boring and Facing Head designed with simplicity of construction and operation in mind.
- This Boring head is very rigid in construction, with very little backlash in the tool carrier due to extra large slide ways.
- Has a boring capacity of 250 mm.
- Takes 12 mm boring tool sizes.

The complete set consists of the following

- Boring Head dia 68 mm.
- ISO 40 Shank.
- 2 Pc 12 mm Carbide Brazed Tools.



Dimension in mm

Item Code No.	Boring Head Dia.	Overall Length	Cross Hole Size	Centre Distance between Holes	Offset	Shanks	Min Bore	Max Bore	Mounting Thread
ABM-IMT-4900	68	72	12	12	25	R8 or ISO40	12	225	24 x 2

Axial & Radial Boring Bar for Boring Head

Dimension in mm

Item Code No.	Item Code No. for Sets	Type	H ∅ D1	F	L1	L2	K°	A/F	INSERT
ABM-IMT-4930		A10 C06	10	5.0	85	10	95°	9.0	CCMT 0602
ABM-IMT-4931	ABM-IMT-4934 Set of 4 Pcs	A12 T11	10	6.0	95	12	90°	9.0	TCMT 1102
ABM-IMT-4932		A16 T11	10	8.0	105	16	90°	9.0	TCMT 1102
ABM-IMT-4933		R75 C06	10	9.0	60	10	90°	9.0	CCMT 0602
ABM-IMT-4940		B10 C06	12	5.0	85	10	95°	11.0	CCMT 0602
ABM-IMT-4941	ABM-IMT-4944 Set of 4 Pcs	B12 T11	12	6.0	95	12	90°	11.0	TCMT 1102
ABM-IMT-4942		B16 T11	12	8.0	105	16	90°	11.0	TCMT 1102
ABM-IMT-4943		R100 C06	12	13.0	72	10	90°	11.0	CCMT 0602
ABM-IMT-4950		D10 C06	20	10.0	85	10	95°	18.0	CCMT 0602
ABM-IMT-4951		D12 T11	20	6.0	95	12	90°	18.5	TCMT 1102
ABM-IMT-4952	ABM-IMT-4955 Set of 5 Pcs	D16 T11	20	8.0	105	16	90°	18.5	TCMT 1102
ABM-IMT-4953		D20 T11	20	10.0	135	20	90°	18.5	TCMT 1102
ABM-IMT-4954		R125 C09	20	19.0	123	15	90°	18.5	CCMT 09T3
ABM-IMT-5000		E12 T11	25	6.0	95	12	90°	23.5	TCMT 1102
ABM-IMT-5001		E16 T11	25	8.0	105	16	90°	23.5	TCMT 1102
ABM-IMT-5002	ABM-IMT-5005 Set of 5 Pcs	E20 T11	25	10.0	135	20	90°	23.5	TCMT 1102
ABM-IMT-5003		E25 T11	25	12.5	160	25	90°	23.5	TCMT 1102
ABM-IMT-5004		R150 C09	25	22.0	134	15	90°	23.5	CCMT 09T3

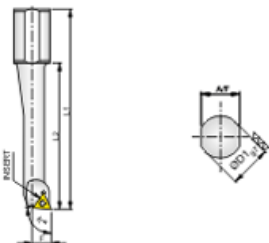
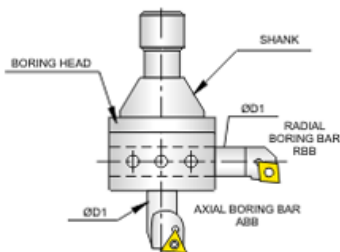

AXIAL BORING BAR

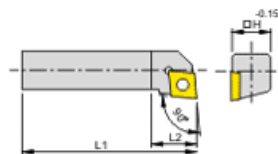

RADIAL BORING BAR

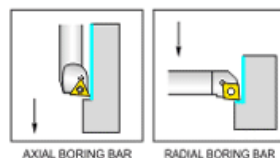

Dimension in inches

Item Code No.	Item Code No. for Sets	Type	H ∅ D1	F	L1	L2	K°	A/F	INSERT
ABM-IMT-5015	ABM-IMT-5019 Set of 4 Pcs	A10 C2	0.39	0.20	3.25	0.39	95°	0.35	CCMT 2
ABM-IMT-5016		A12 T2	0.39	0.24	3.75	0.47	90°	0.35	TCMT 2
ABM-IMT-5017		A16 T2	0.39	0.31	4.25	0.63	90°	0.35	TCMT 2
ABM-IMT-5018		R75 C2	0.39	0.35	2.50	0.39	90°	0.35	CCMT 2
ABM-IMT-5025	ABM-IMT-5029 Set of 4 Pcs	B10 C2	0.50	0.20	3.25	0.39	95°	0.43	CCMT 2
ABM-IMT-5026		B12 T2	0.50	0.24	3.75	0.47	90°	0.43	TCMT 2
ABM-IMT-5027		B16 T2	0.50	0.31	4.25	0.63	90°	0.43	TCMT 2
ABM-IMT-5028		R100 C2	0.50	0.51	2.75	0.39	90°	0.43	CCMT 2
ABM-IMT-5035	ABM-IMT-5040 Set of 5 Pcs	D10 C2	0.79	0.29	3.25	0.39	95°	0.71	CCMT 2
ABM-IMT-5036		D12 T2	0.79	0.24	3.75	0.47	90°	0.73	TCMT 2
ABM-IMT-5037		D16 T2	0.79	0.31	4.25	0.63	90°	0.73	TCMT 2
ABM-IMT-5038		D20 T2	0.79	0.39	5.25	0.79	90°	0.73	TCMT 2
ABM-IMT-5039		R125 C3	0.79	0.75	4.75	0.59	90°	0.73	CCMT 3
ABM-IMT-5045	ABM-IMT-5050 Set of 5 Pcs	E12 T2	1.0	0.24	3.75	0.47	90°	0.92	TCMT 2
ABM-IMT-5046		E16 T2	1.0	0.31	4.25	0.63	90°	0.92	TCMT 2
ABM-IMT-5047		E20 T2	1.0	0.39	5.25	0.79	90°	0.92	TCMT 2
ABM-IMT-5048		E25 T2	1.0	0.50	6.25	1.0	90°	0.92	TCMT 2
ABM-IMT-5049		R150 C3	1.0	0.87	5.25	0.59	90°	0.92	CCMT 3

Shanks for Boring Heads



- The boring head shank adapts our boring head to the mini mill with a Morse taper spindle.
- Fits all heads with threaded back. Taper shanks are mounted directly to the machine spindle.

Imperial Sizes

Item Code No.	Style	Draw Bar	Mounting thread	Suitable for Boring Head
ABM-IMT-4845	R 8	7/16" UNF	7/8" UNF	2" / 3" / 4"
ABM-IMT-4846	MT 2	3/8" BSW	7/8" UNF	2" / 3" / 4"
ABM-IMT-4847	MT 3	1/2" BSW	7/8" UNF	2" / 3" / 4"
ABM-IMT-4848	R 8	7/16" UNF	1-1/2" X 18 TPI	2" / 3" / 4"
ABM-IMT-4849	MT 2	3/8" BSW	1-1/2" X 18 TPI	2" / 3" / 4"
ABM-IMT-4850	MT 3	1/2" BSW	1-1/2" X 18 TPI	2" / 3" / 4"
ABM-IMT-4851	MT 4	5/8" BSW	1-1/2" X 18 TPI	2" / 3" / 4"

METRIC Sizes

Item Code No.	Style	Draw Bar	Mounting thread	Suitable for Boring Head
ABM-IMT-4830	12 MM	--	M 14 x 1.0	30 & 38 mm
ABM-IMT-4831	MT 1	M 6	M 14 x 1.0	30 & 38 mm
ABM-IMT-4832	MT 2	M 10	M 14 x 1.0	30 & 38 mm
ABM-IMT-4833	MT 3	M 12	M 14 x 1.0	30 & 38 mm
ABM-IMT-4834	MT 1	M 6	1-1/2" X 18 TPI	50 / 75 / 100 mm
ABM-IMT-4835	MT 2	M 10	1-1/2" X 18 TPI	50 / 75 / 100 mm
ABM-IMT-4836	MT 3	M 12	1-1/2" X 18 TPI	50 / 75 / 100 mm
ABM-IMT-4837	MT 4	M 16	1-1/2" X 18 TPI	50 / 75 / 100 mm
ABM-IMT-4838	ISO 30	M 12	1-1/2" X 18 TPI	50 / 75 / 100 mm
ABM-IMT-4839	ISO 40	M 16	1-1/2" X 18 TPI	50 / 75 / 100 mm
ABM-IMT-4840	ISO 50	M 24	1-1/2" X 18 TPI	50 / 75 / 100 mm
ABM-IMT-4841	BT 30	M 12	1-1/2" X 18 TPI	50 / 75 / 100 mm
ABM-IMT-4842	BT 40	M 16	1-1/2" X 18 TPI	50 / 75 / 100 mm
ABM-IMT-4843	BT 50	M 24	1-1/2" X 18 TPI	50 / 75 / 100 mm

Screw Extractor



- Screw extractors are recommended for simple low cost removal of broken screws, bolts etc. without damaging the threads of component.
- Hardened and Tempered.

Item Code No.	Diameter for Removing Screws	Square Size
ABM-IMT-4700	3/32" to 5/32"	3/32"
ABM-IMT-4701	5/32" to 7/32"	5/32"
ABM-IMT-4702	7/32" to 9/32"	3/16"
ABM-IMT-4703	9/32" to 3/8"	15/64"
ABM-IMT-4704	3/8" to 5/8"	21/64"

Single Point Diamond Dresser

(a) With Knurled Body



(b) Normal Body



- High quality Diamonds.
- Can be available in any Shank size on request.
- Available in shank sizes 1/4", 3/8", 7/16", 1/2" and over all length 1-1/2" to 6"
- Ideal tool for dressing wheels for Surface Grinders, Universal Grinders, Cylindrical Grinders, centre less grinders etc.
- Carat size available: 0.16, 0.25, 0.35, 0.50, 0.75, 1.00, 1.25, 1.50, 2.00, 2.50, 3.00, 3.50, 4.00, 5.00
- Carat Sizes 1/4, 1/3, 1/2, 3/4, 1, 1-1/4, 1-1/2, 2, 2-1/2, 3, 3-1/2, 4 and 5

Knurled Body Item Code No.	Normal Body Item Code No.	Carat Size
ABM-IMT-5300	ABM-IMT-5320	0.16
ABM-IMT-5301	ABM-IMT-5321	0.25
ABM-IMT-5302	ABM-IMT-5322	0.35
ABM-IMT-5303	ABM-IMT-5323	0.50
ABM-IMT-5304	ABM-IMT-5324	0.75
ABM-IMT-5305	ABM-IMT-5325	1.00
ABM-IMT-5306	ABM-IMT-5326	1.25
ABM-IMT-5307	ABM-IMT-5327	1.50
ABM-IMT-5308	ABM-IMT-5328	2.00
ABM-IMT-5309	ABM-IMT-5329	2.50
ABM-IMT-5310	ABM-IMT-5330	3.00
ABM-IMT-5311	ABM-IMT-5331	3.50
ABM-IMT-5312	ABM-IMT-5332	4.00
ABM-IMT-5313	ABM-IMT-5333	5.00

Low Boy Angle Dressers

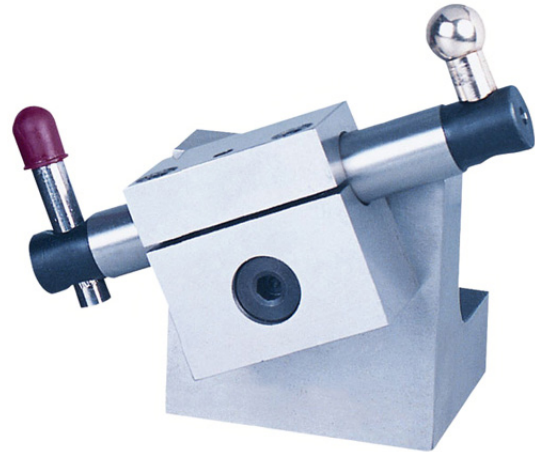

- Designed for use on all Grinding Machines.
- Base Angle-Plate is Heavy, Precision Ground, Square on all six sides
- Side Block Pivots on Hardened Shoulder Screws.
- Includes Diamond Dresser : 3/8" (9.5 mm) x 3" (75 mm) (1/4 Carat).

Item Code No.	Description
ABM-IMT-5350	Complete with Diamond Dresser
ABM-IMT-5351	Replacement Dresser only 3/8" (9.5 mm) x 2" (50 mm) (1/4 Carat)

High Low Adjustable Dressers

- Designed for use on all Grinding Machines.
- Dress O.D. and face of Wheels.
- Adjustable to 7" (175 mm) Height.
- Dress any Width.
- Rugged construction.
- Includes Diamond Dresser : 3/8" (9.5 mm) x 3" (75 mm) (1/4 Carat).



Item Code No.	Description
ABM-IMT-5355	Complete with Diamond Dresser
ABM-IMT-5356	Replacement Dresser only 3/8" (9.5 mm) x 3" (75 mm) (1/4 Carat)

Cluster Diamond Dressers Multipoint



- The cluster type diamond dresser is ideal for coarse or rough dressing of grinding wheels in size up to 80 grit (mainly rough grinding or grinding to eliminate imbalance).
- The diamonds can be fully utilized without re-setting or re-sharpening.
- Diamond Grinding Disc Wheel Stone Dresser Tool Dressing Bench Grinder
- These Diamond Wheel Dressers are made from Diamond head with a knurled handle for secure grip
- 30 mm x 13 mm Diamond Grinding Block
- Knurled Handle for Firm Grip
- Overall length 118 mm
- Re-Shapes Worn Wheels To Give True Grinding Surface
- Creates Very Little Dust Without Chipping
- Dresses across the width of grinding wheels to give a flatter surface
- To get the maximum performance from your bench grinder, it's imperative that the grinding wheels are regularly 'dressed' across their width to maintain their balance and ensure a 'true' grinding profile.
- Restores and prolongs the life of grinding wheels
- This diamond dresser is a simple way of returning your grinding wheel to tip-top condition.

TWO STYLES

- Rough Dressing** – one Layer of Small Whole Diamond
Contains 3 Carat Diamonds arranged on one Layer in 3 Rows
- Finishing Dressing** – Impregnated/Sintered with Diamond Particles
Contains 5 Carat Diamonds Impregnated/Sintered

Item Code No.	Style	Description
ABM-IMT-8640	Rough Dressing	Cluster Diamond Type
ABM-IMT-8641	Finish Dressing	Impregnated / Sintered Diamond Type

Cluster Diamond Dressers Multipoint



- The cluster type diamond dresser is ideal for coarse or rough dressing of grinding wheels in size up to 80 grit (mainly rough grinding or grinding to eliminate imbalance).
- The diamonds can be fully utilized without re-setting or re-sharpening.
- Shanks are chrome plated.
- Shank Size x Length in inches - 5/8" x 7".
- High quality multi diamonds are used to give proper dressing to the wheels.

Item Code No.	No of Diamonds	Diamond Weight
ABM-IMT-8630	3	0.5
ABM-IMT-8631	5	0.75
ABM-IMT-8632	7	1.05

Diamond Nib Holder

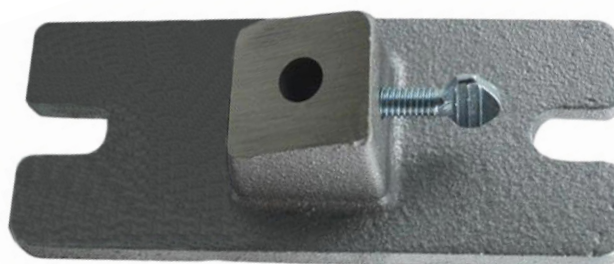

- Designed for use on surface grinders.
- Holds diamond dresser at proper 15° Degree angle.
- Base dimension ; 2-1/2" x 6"
- Key Way : 1/2" Wide x 7/8".
- Include 1/4 carat diamond dresser 7/16" x 2".

Item Code No.	Description
ABM-IMT-5380	Holder only, without Diamond Dresser
ABM-IMT-5381	Complete with Diamond Dresser
ABM-IMT-5382	Replacement Dresser only 7/16 x 2" (50 mm) (1/4 Carat)

Wheel Dressers

Emry Wheel Dressers & Cutters (Huntington Type)



- Sturdy construction.
- Made of cast Iron.
- Must for every industry.

Item Code No.	Handle Length	Description
ABM-IMT-5370	250 mm	No. 0 for Wheels upto 10" (250 mm) Dia. x 2" (50 mm)
ABM-IMT-5371	262 mm	No. 0 for Wheels upto 15" (380 mm) Dia. x 3" (75 mm)
ABM-IMT-5372	350 mm	No. 2 for Higher Sizes Wheels

Item Code No.	Description
ABM-IMT-5373	Spare Cutter for No. 0 Dresser
ABM-IMT-5374	Spare Cutter for No. 1 Dresser
ABM-IMT-5375	Spare Cutter for No. 2 Dresser
ABM-IMT-5376	3 Pc Wheel Dresser Set No 0, 1 and 2

Pocket Magnets

U Magnets - Horse Shoe Magnets

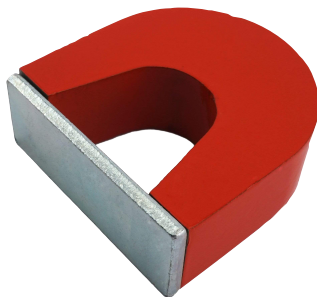

- Conventional permanent magnets with many uses.
- They are handy but strong.
- Supplied with keeper.
- Pocket magnet for workshop, laboratory, hobby, fixtures, tools, sensors and collection of small metal parts.

Item Code No.	Length mm	Width mm	Height mm	Gap Width mm	Weight Grams	Max Pull Kg.
ABM-IMT-8610	22.2	7.9	25.4	6.4	30 Grams	2.4
ABM-IMT-8611	27	15.9	35	7.9	90 Grams	4

Hand Diamond Dressers



- Dressers fitted with plastic handle to give firm position to fist.
- Available in any Shank size.
- Shank diameter 7/16" (11 mm) and overall length 8" (200 mm)
- Chrome finish body.
- Ideal tool for dressing wheels for surface grinders, universal grinders, etc.
- High quality diamonds are used to give proper to the wheels.

Item Code No.	Diamond Size Carat
ABM-IMT-5385	1/4
ABM-IMT-5386	1/3
ABM-IMT-5387	1/2
ABM-IMT-5388	3/4
ABM-IMT-5389	1
ABM-IMT-5390	1-1/2
ABM-IMT-5391	2
ABM-IMT-5392	3
ABM-IMT-5393	4
ABM-IMT-5394	5

Mini Magnetic Stand

Mini Magnetic Base

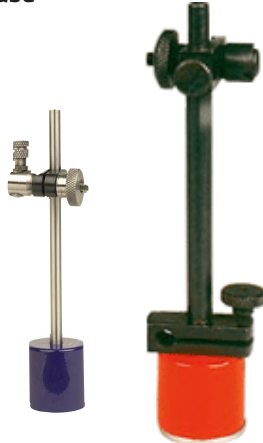

- Compact and universal permanent magnetic stand.
- High magnetic power for maximum rigidity.
- Includes disc on bottom for neutralizing magnet when not in use.
- Available with or without Fine Adjustment.

Item Code No.	Base Dia.		Total Height	
	Inch	mm	Inch	mm
ABM-IMT-5400	1-1/8"	28	5"	125
ABM-IMT-5401 With Fine Adjustment	1-1/8"	28	5-3/8"	135

Power Magnets

Power Magnet with T Handle



- Have tremendous power.
- Have many applications in material handling & machine shop.
- Supplied with T Type handle for easy grip and lifting.

Item Code No.	Diameter x Thickness	
	Inches	mm
ABM-IMT-5430	2-1/2 x 3/4	65 x 20
ABM-IMT-5431	3 x 3/4	75 x 20
ABM-IMT-5432	4 x 3/4	100 x 20
ABM-IMT-5433	5 x 3/4	125 x 20

Mini Magnetic Stand

Mini Magnetic Base



- Magnetic base used in metalworking to hold dial indicators and also used in other fields, such as optics.
- Compact and universal permanent magnetic stand.
- High magnetic power for maximum rigidity.
- Includes disc on bottom for neutralizing magnet when not in use.
- Clamps indicator with stem as well as dovetail.

Item Code No.	Base Dia.		Total Height	
	Inch	mm	Inch	mm
ABM-IMT-5410	1-1/8"	28	3-1/8"	80
ABM-IMT-5411 With Fine Adjustment	1-1/8"	28	5-3/8"	135

Extra Power Magnetic Hold Fast

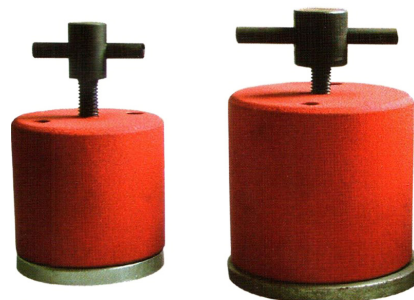

- Have Tremendous Power.
- Provided with Push OFF Screw to Push Work Away from the Hold Fast as these cannot be done by hand.
- Can be used to Hold Work for Welding, Grinding and are ideal for making inexpensive lifting devices and jigs.
- Have many application in material handling and machine shop
- Also provided with plated keepers which protect and retain magnetic field

Item Code No.	Diameter		Magnetic Pull	
	Inch	mm	Lbs	Kg
ABM-IMT-5420	1-3/4"	44	45	20
ABM-IMT-5421	2-1/8"	54	70	30
ABM-IMT-5422	2-3/4"	70	110	50
ABM-IMT-5423	4"	100	220	100

Button Magnets

- Have both the poles at each end of the cylinder and are separated by a groove in the center.
- These magnets also have a plain fixing hole.
- Mainly used for gripping applications.
- Supplied with keeper.
- Button Magnets are simply horseshoe magnets in a compact circular format.
- They are made from alnico to provide a high resistance to corrosion and a high temperature rating.
- All sizes have clearance holes for mounting.
- They must not be recessed into ferrous materials as it will short circuit the magnetism.

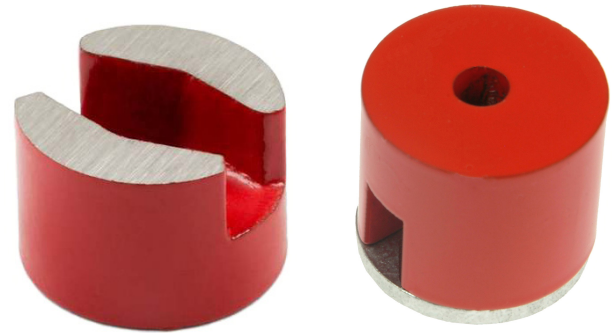

Item Code No.	Diameter		Height		Magnetic Pull	
	Inch	mm	Inch	mm	Lbs	Kgs
ABM-IMT-8570	0.500"	12.5	0.375"	9.5	1.5	0.6
ABM-IMT-8571	0.750"	19	0.500"	12.5	4.2	1.9
ABM-IMT-8572	0.874"	22	0.750"	19	6.6	3.0
ABM-IMT-8573	1.000"	25	0.625"	16	7.5	3.4
ABM-IMT-8574	1.250"	32	1"	25	10.6	4.8

Magnetic Quick Clamp Multiangle (Magnetic Welders Clamp)

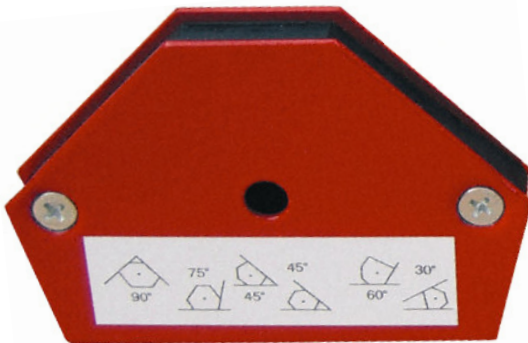

Item Code No.
ABM-IMT-5460



- Magnetic Quick Clamps is Designed to enable fast and accurate holding of ferrous metals for welding and Assembly.
- Jobs 30°, 45°, 60°, 75°, 90°
- Size 4" x 2-5/8" (110 mm x 65 mm)
- Useful for welder's purpose.
- Body hole enables it to be built into jigs or can be hung when not in use.

Pot Magnets



- Has unlimited applications, such as magnetic fasteners, displays, Holding Maps etc.
- Pot magnets are permanent magnet encased in a steel shell, which is sometimes called a pot, hence the name 'pot' magnet. A permanent magnet emits a magnetic field without the need for any electricity.
- Has Tapped hole of 1/4" (20 TPI) on back side for attaching to fixtures and machines. ▪ Comes with Nickel Plated Keepers.
- Powerful AlNiCo magnets encased in steel pot with aluminium insulation.
- Compact design with very strong magnetic pull makes these a favorite in all workshops, tool rooms etc.

Item Code No.	Diameter		Height		Pull	
	Inch	mm	Inch	mm	lbs	Kg
ABM-IMT-5440	11/16	17.5	5/8	16	6	2.7
ABM-IMT-5441	13/16	20	3/4	19	10	4.5
ABM-IMT-5442	1-1/16	27	1	25	14	6
ABM-IMT-5443	1-3/8	35	1-3/16	30	30	13.5
ABM-IMT-5444	Set of 4 Pcs of the Above Mentioned Sizes					

Universal Magnetic Indicator Holder

- Two Universal Ball sockets permits adjustments to any angle or position
- Dovetail Clamp for Test Indicators.
- 1/4" Hole for 1/4" Stem Indicators.
- Provided with extension rod 1/4" x 3-1/2"
- Powerful Magnetic Force.
- Available with or without fine adjustments

Item Code No.	Base Dia.		Body Height	
	Inch	mm	Inch	mm
ABM-IMT-5450	1-3/16"	30	4-3/4"	120
ABM-IMT-5451 With Fine Adjustment	1-3/16"	30	4-3/4"	120



Magnetic Adjustable Links Magnetic Welding Links

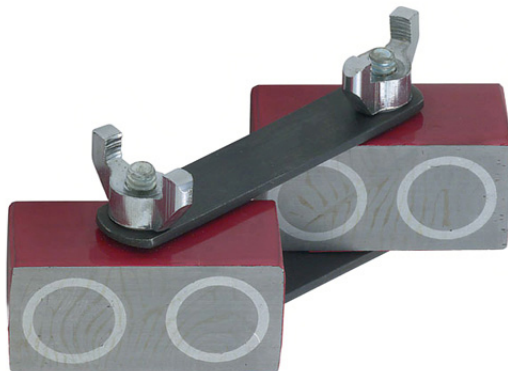

- Widely used for Holding and Welding.
- Can be set at any angle by adjustment and locking of wing nut.
- Compact in size for holding work in confined spaces.
- Available with ferrite or alnico (for higher temperatures) magnet materials .
- Made of two rectangular blocks consisting of two magnets in each block.
- The wing nut are fitted for easy angular adjustments.
- Magnetic pull is 25 Kg.

Item Code No.	Length		Width		Height	
	Inch	mm	Inch	mm	Inch	mm
ABM-IMT-5455	4-5/8	115	2	50	1	25

Magnetic Welders Clamp



Item Code No.
ABM-IMT-8565

Magnetic Quick Clamp – Multiangle

- Magnetic Quick Clamps is Designed to enable fast and accurate holding of ferrous metals for welding and Assembly.
- Jobs 30°, 90° & 135°
- Size 4-5/8" x 3-3/4" (120 mm x 95 mm)
- Useful for welder's purpose.
- Body hole enables it to be built into jigs or can be hung when not in use.



Shallow Ceramic Magnets

- Permanent, powerful magnets to hold, lift and attract metal parts.
- Shallow depth permits use in confined spaces.
- Threaded center hole for fastening with machine screw.
- Large sizes have 3/8" clearance holes for fastening with rods or bolts.



Item Code No.	Diameter		Height		Approx Pull	
	Inch	mm	Inch	mm	Lbs	Kgs
ABM-IMT-5470	1-3/8	35	5/16	8	12	5.5
ABM-IMT-5471	1-3/4	44.4	1/4	6.35	19	9.0
ABM-IMT-5472	2	50.8	3/8	9.50	22	10.0
ABM-IMT-5473	2-3/4	70	7/16	11.10	33	15.0
ABM-IMT-5474	3-1/8	80	1/2	12.70	55	25.0
ABM-IMT-5475	Set of 4 Pcs Shallow Magnets (Dia. 35, 44.4, 50.8 & 70 mm)					

Magnetic Welding Links

Item Code No.
ABM-IMT-5515

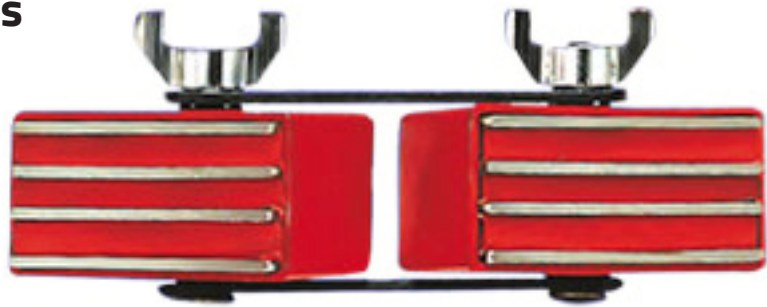

- **Also known as Magnetic Adjustable Links**
- An adjustable links magnet is a type of weld clamp magnet where each magnet can be completely rotated.
- Adjustable links magnets can be adjusted to angles between 0° and 360°.
- Adjustable Magnetic Welding Link is ideal for welding, brazing and soldering. It eliminates the need for clamps or temporary fasteners.
- The angles are achieved by tightening/loosening the wing nuts on each magnet which allows the magnets to move freely to the desired angle.
- Ideal for holding steel parts for welding, brazing etc.
- Used for welding and holding steel parts in confined areas.
- Wing nut Adjustment.
- No Clamp Needed.
- Two heavy magnetic blocks linked together for easy adjustment.
- Overall Length 4-5/8 (115mm) & Overall Width 2" (50 mm)

Magnetic Welding Squares



- Ideal for round and square tubing, angle, and flat stock.
- Easy to clean. Simply turn Off and wipe.
- The fast & easy way to hold metal workpieces.
- Through Holes for easy mounting and fixturing.
- Large finger hole for easy setup and removal.

Item Code No.	Description	Size (l x h)		Approx Vertical Pull	
		Inch	mm	Lbs	Kg
ABM-IMT-5490	Welders Magnetic Square Open Small	3-3/8 x 3-3/8	85 x 85	33	15
ABM-IMT-5491	Welders Magnetic Square Open Big	4-3/8 x 3-3/4	100 x 95	45	20
ABM-IMT-5492	Welders Magnetic Square Enclosed Big	4-3/8 x 3-3/4	100 x 95	45	20

Magnetic Clamp Set

- Permanent, powerful magnets to hold, lift and attract metal parts.
- Shallow depth permits use in confined spaces.
- ASM-0656 has 10 x 24 threaded center hole for fastening with machine screw.
- Large sizes have 3/8" clearance holes for fastening with rods or bolt.
- A pair of powerful triangular magnets designed to hold separate pieces of ferrous material in position at fixed angles prior to and during welding.

Item Code No.	Description
ABM-IMT-5500	2 Pcs Set of Magnetic Square & Multiangle 4-3/8" x 3-3/4" and 4" x 2-5/8" (110 x 95 and 100 x 65 mm)



Magnetic Clamps

- Hold work firmly at 45°, 90° or 135° degree angles.
- Large models supplied with 'T' handle to 'break' magnet from work.

Item Code No.	Nominal Width	Nominal Height	Nominal Thickness	Average Pull
ABM-IMT-5505 Chunky	3-3/4"	4-3/8"	1-1/2"	100 lbs
ABM-IMT-5506 Big Daddy	8"	8"	1-5/8"	100 lbs



Magnetic Quick Clamp

Double

Item Code No.
ABM-IMT-5480

- Versatile angular clamps for wide range of application.
- Bayard Magnatic clamps feature strong magnet individually tested.
- Size 6-1/4" x 3-3/8" (155 mm x 85 mm)



Magnetic Ground Clamps

- Utilizes a spring loaded electrode that secures ground to work surface
- Stud assembly allows ground wire to rotate 360 degrees, free of work area
- Convenient handle for easy gripping



Item Code No.	Model	Approx Dia.		Approx Vertical Pull	
		Inch	mm	Lbs	Kg.
ABM-IMT-5510	Welders Magnetic ground clamps 800 AMP	3-7/16"	85	75	35
ABM-IMT-5511	Welders Magnetic ground clamps 250 AMP	3-7/16"	85	75	35

Magnetic Base with Safety Shield

- Magnetic base used in metalworking to hold dial indicators and also used in other fields, such as optics.
- Prevents Accidents. Grips Flat or Round surfaces.
- Fits lathes, Grinders, Shapers Etc. Provided with crystal clear flat shield.
- Shield Swivels 360 Degree and locks in place.



Item Code No. Complete Set	Item Code No. Replacement Shield Only	Total Length	
		Inch	mm
ABM-IMT-5520	ABM-IMT-5526	6 x 8	150 x 200
ABM-IMT-5521	ABM-IMT-5527	8 x 10	200 x 250
ABM-IMT-5522	ABM-IMT-5528	10 x 12	250 x 300
ABM-IMT-5523	ABM-IMT-5529	12 x 16	300 x 450
ABM-IMT-5524	ABM-IMT-5530	16 x 20	400 x 500
ABM-IMT-5525	Magnetic Base only without Shield		

Magnetic Base (Push Button) (Standard Magnetic Bases)



Magnetic Base (High Power)



- A magnetic base is a magnetic fixture based on a magnet that can effectively be turned 'on' and 'off' at will.
- Used in optics and metalworking, e.g., to hold a dial indicator.
- Provided with ON / OFF Push Button.
- Specially designed to use with Dial Gauges to work on Surface Plate and Machine Tables.
- Magnetic Pull on base and Two Sides.
- Magnetic pull 25 Kg (55 lbs) approximately.
- Clamping system suitable for dial gauges with lug back of 1/4". Clamping hole for 8 mm also available on request.
- Available with or without Fine Adjustment.

- Magnetic Base – High Power used in optics and metalworking, e.g., to hold a dial indicator.
- Made of Fine quality permanent alnico magnet.
- Smooth Easy ON / OFF Switch
- Horizontal or Vertical Positioning Capability.
- V Grooved base for mounting on Cylindrical parts.
- Accepts all dial indicators with 1/4", 5/16", 3/8", 8 mm Stem and 1/4" Lug Back.
- Magnetic pull approx. 50 – 60 Kg. (110 – 130 LBS)

Item Code No.	Overall Height		Base Dimension (l x w x h)	
	Inch	mm	Inch	mm
ABM-IMT-5540	9-1/4	235	1-7/8 x 1-3/4 x 2	48 x 45 x 50
ABM-IMT-5541 (With Fine Adjustment)	9-1/4	235	1-7/8 x 1-3/4 x 2	48 x 45 x 50

Item Code No.	Overall Height		Base Dimension (l x w x h)	
	Inch	mm	Inch	mm
ABM-IMT-5550	9-1/2	240	2-1/2 x 1-7/8 x 2-1/8	63 x 48 x 55
ABM-IMT-5551 (With Fine Adjustment)	9-1/2	240	2-1/2 x 1-7/8 x 2-1/8	63 x 48 x 55
ABM-IMT-5552 (Base Only)			2-1/2 x 1-7/8 x 2-1/8	63 x 48 x 55

Magnetic Base (High Power) Flexible Arm

- Magnetic base is capable of reaching every possible position – even upside down.
- It is an auxiliary tool for any general measurement and helps to increase precision and working efficiency.
- Articulated Arm Style Alnico Magnetic Base, Positions and Locks easily.
- Includes ON/OFF switch and central locking knob to tighten both arms.
- Includes two ball joints and one central cylindrical joint.
- Dial gage holder includes fine adjustment and full 360 Degree Swivel.
- Clamping system suitable for dial gauges with stem of 1/4", 5/16" and 3/8" and dovetail indicators
- Magnetic pull approx. 60 kg. (130 LBS)

Item Code No.	Overall Height		Base Dimension (l x w x h)	
	Inch	mm	Inch	mm
ABM-IMT-5560	14	335	2-1/2 x 1-7/8 x 2-1/8	63 x 48 x 55

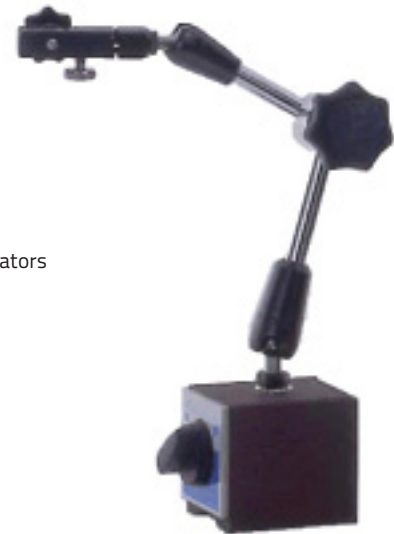

Magnetic Chuck Parallels and Universal V Blocks

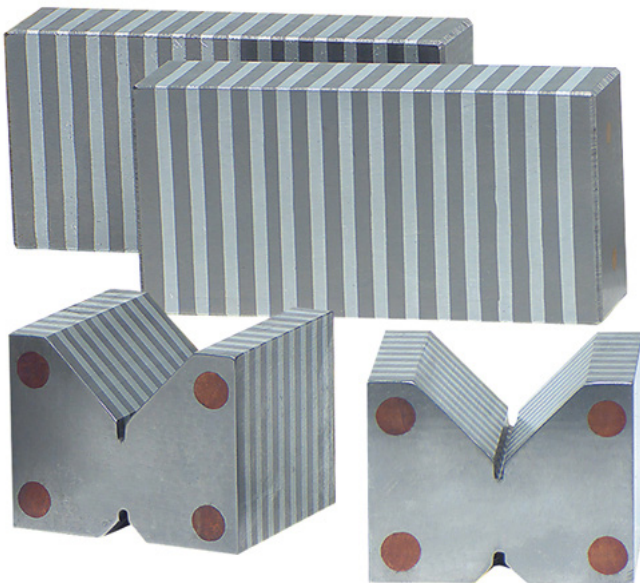

- Ground Steel used for highest magnetic transfer and is cast integrally with aluminium.
- Parallels are ground all over.
- V-Blocks are universal.

Item Code No.	Description	Size Inch
ABM-IMT-5570	One Pair Magnetic Chuck Parallel	1" x 2" x 4"
ABM-IMT-5571	One Pair Magnetic Chuck V Block	1-7/8" x 2-3/8" x 2" Large V Capacity 2" Round Small V Capacity 1/2" Round
ABM-IMT-5572	One Magnetic Chuck Long V Block	1-7/8" x 2-3/8" x 4-3/8" Large V Capacity 2" Round Small V Capacity 1/2" Round
ABM-IMT-5573	One Pair Magnetic Chuck Long V Block	
ABM-IMT-5574	Combination Set of ABM-IMT-5570 & ABM-IMT-5571	

Universal Clamps



- Black finished clamps for use with magnetic bases and dial gauges with 1/4" F Stand.
- One clamp for dovetails and universal indicators.

Item Code No.	Clamping Hole	
	Inch	mm
ABM-IMT-5580	1/8 - 1/4	3 - 6.35

Magnetic V Block Set

- Magnetic V Blocks required for Quality Control, Tool Room and Standard Room for variety of application in Tooling and Inspection purposes.
- Magnetic V-Block has a total 3 Magnetic surfaces.
- Top and bottom with 90° V-Angle and end surface opposite to switch.
- All working surfaces are precision ground.
- Ideal for holding, inspection and light machining.
- Suitable for holding Round or Irregular shaped for Scribing, Grinding etc., Grinding, Measuring and Machining.
- Accuracy of Vee is within 0.0003" (0.007 mm).
- A powerful, permanent magnet is controlled by Rotary ON / OFF Switch.
- Supplied in fine finished Wooden Box.
- Available in single and Dual Vee.



Item Code No.	Pcs.	Length		Width		Height	
		Inches	mm	Inches	mm	Inches	mm
ABM-IMT-5590	Single	2-3/16	55	1-3/4	45	1-15/16	50
ABM-IMT-5591	Single	2-3/4	70	2-1/8	73	2-7/8	73
ABM-IMT-5592	Single	4	100	2-3/4	70	3-3/4	95
ABM-IMT-5593	Pair	4	100	2-3/4	70	3-3/4	95
ABM-IMT-5594	Single	6	150	3	75	3-3/4	95
ABM-IMT-5595	Pair	6	150	3	75	3-3/4	95
ABM-IMT-5596	Single	8	200	6	150	4	100
ABM-IMT-5597	Pair	8	200	6	150	4	100

Magnetic Back for Dial Indicator

- Permanent powerful Magnet.
- Attaches to the back of 2" diameter AGD Dial indicators.



Item Code No.	Diameter		Thickness	
	Inch	mm	Inch	mm
ABM-IMT-5615	2-1/4"	57	1/2"	12.5

Magnetic Base Holder

- Magnet is molded in plastic case.
- Heavy-duty magnetic base.
- Grips curved & flat metal surfaces.

Item Code No.	Description	Base Size	
		Inches	mm
ABM-IMT-8560	Magnetic Base Complete with Assembly	2 x 1-1/2 x 1-1/4	50 x 38 x 32
ABM-IMT-8561	Magnetic Base Holder Only	2 x 1-1/2 x 1-1/4	50 x 38 x 32



Magnetic Chuck (Rectangular)

- Permanent magnetic chucks are manufactured from magnetized materials and exhibit a constant magnetic field without needing to introduce an electric current.
- High Powered Chucks.
- Ease of installation for transfer from one machine to another.
- Solid Top and Bottom Plates assure retained accuracy.
- Full loading power over entire plates.
- Has a positive hand release.
- Pole Divisions are arranged for holding Small, Thin and large pieces.
- Available in Standard Poles & Straight Poles.

Item Code No.	Size	
	Inch	mm
ABM-IMT-5600	4 x 7	100 x 175
ABM-IMT-5601	4 x 8	100 x 200
ABM-IMT-5602	5 x 10	125 x 250
ABM-IMT-5603	6 x 12	150 x 300
ABM-IMT-5604	6 x 14	150 x 355
ABM-IMT-5605	6 x 18	150 x 455
ABM-IMT-5606	8 x 12	200 x 300
ABM-IMT-5607	8 x 15	200 x 380
ABM-IMT-5608	8 x 18	200 x 455
ABM-IMT-5609	8 x 20	200 x 505
ABM-IMT-5610	8 x 24	200 x 610
ABM-IMT-5611	12 x 24	300 x 610

While placing order please mention Standard or Straight Poles



Magnetic Chuck (Round)

- Magnetic round chucks used when the workpiece needs to be rotated during machining.
- They have magnetic poles that run concentric to each other throughout the diameter of the chuck and are separated from each other by a steel section.
- Magnetic lathe chuck are alternative method of mechanical methods of workholding and are becoming more common in a variety of metalworking industries.
- High Powered Chucks.
- Solid Top and Bottom Plates assure retained accuracy.
- Full loading power over entire plates.
- Pole Divisions are arranged for holding Small, Thin and large pieces.
- Available in Standard Poles & Straight Poles.

Item Code No.	Size	
	Inch	mm
ABM-IMT-5630	3	75
ABM-IMT-5631	4	100
ABM-IMT-5632	5	125
ABM-IMT-5633	6	150
ABM-IMT-5634	8	200
ABM-IMT-5635	9	225
ABM-IMT-5636	10	250
ABM-IMT-5637	12	300
ABM-IMT-5638	15	380
ABM-IMT-5639	16	400
ABM-IMT-5640	18	450
ABM-IMT-5641	20	500

While placing order please mention Standard or Straight Poles





Universal Mighty Magnetic Base

- Universal Magnetic base that saves time and improves accuracy.
- Strong Magnetic Holding Power.
- Zinc Die Cast Housing.
- 5 Different locations for mounting accessories.
- 3 positions 1/4-20 for Lug mounts.
- 1 tapped hole 10-32.
- One reamed hole 3/8".

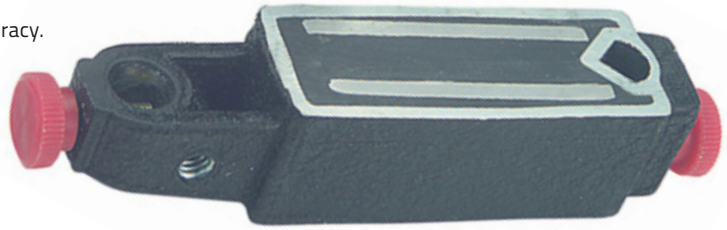

Item Code No.	Size	
	Inch	mm
ABM-IMT-5645	4-1/2" x 1" x 1-1/4"	112 x 25 x 28

Gage Handle (Universal Pin Gage Handle)

Item Code No.
ABM-IMT-5650



- Suitable for handling all plug gages from F 1/32" through 1/2", 0.79 to 12.7 mm.
- Go and No-Go clearly marked.
- Made from aluminium alloy.

Magnet Cleaner

- Comes with strong magnet and comfortable hand grip.
- Very useful tool for picking iron pieces from floor or distant places.
- Handy powerful iron cleaner.

Item Code No.	Description	Total Length		Magnet Size	
		Inch	mm	Inch	mm
ABM-IMT-5655	Round	40	1000	3-1/8	80



Magnetic Separator

- Hand tool that saves the hands and time.
- Good for parts and assembly transfer.
- Picks up scattered parts.
- Separates scrap iron from non-ferrous products.
- Specially designed for separating ferrous sheets or particles.
- Very useful in workshops for cleaning machine beds, agriculture industry etc.
- Powerful magnetic force can be demagnetized by simply pulling up the handle.



Item Code No.	Length x Width x Thickness	
	Inch	mm
ABM-IMT-5660	9-1/4" x 5-1/4" x 1"	235 x 135 x 25



Magnetic and Dressing Tools



Pocket Magnet



- Light Weight Aluminium Shaft.
- Powerful Magnet.
- Comes with Pocket Clip.
- Very Handy Tool.
- The Pocket Magnetic Pickup is a handy companion tool for retrieving small metal parts such as screws, bolts and metal shavings. Great for snagging fallen wrenches or other tools.

Item Code No.	Total Length	
	Inch	mm
ABM-IMT-5665	6	150

Bend-It Magnet



- Bendable shaft which bends to any shape.
- Retrieves iron objects from hard-to-reach places such as car engines.
- Powerful permanent magnetic tip.

Item Code No.	Reach	
	Inch	mm
ABM-IMT-5670	21	540

Magnetic Pickup Tool

Telescopic Pick Up Magnet

- Light weight magnetic pick up which extends to 25-7/8" (657 mm).
- Compact size with handy pocket clip.
- Powerful magnetic tip lifts heavy key rings, nails, screws, pins and more.
- Very Popular Pickup Tool.

Item Code No.	Description
ABM-IMT-5675	With Clip
ABM-IMT-5676	Without Clip

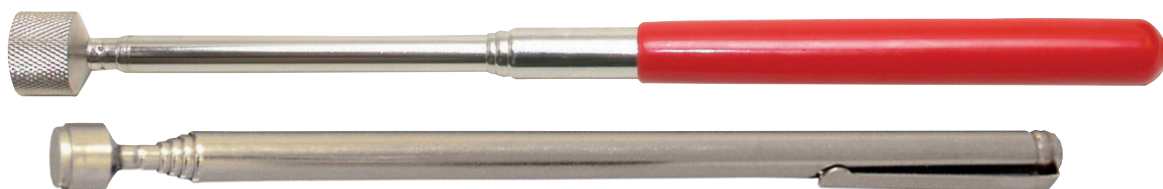

Magnetic Swarf Wand



- Stainless Steel Tube With Powerful Magnet Inside.
- Used To Collect The Ferrous Swarf .
- Assembled With Plunger to push & pull out and release the Swarf.
- A Must to have in every garage & tool room.
- Quick and safe pick up of iron and steel offcuts, filings, chips and general swarf
- Features a quick release handle
- Lightweight and extremely durable – non-rusting

Item Code No.	Description	Total Length
ABM-IMT-8600	Round	16" / 400 mm
ABM-IMT-8601	Round	1 Meter / 1000 mm

Magnetic Holder - With Clip



- Available with pocket clip.
- Used for holding in Construction, D.I.Y., Hammers, Nails etc.
- Magnetic pull 5 kgs / 11 Lbs.

Item Code No.	Size	
	Inch	mm
ABM-IMT-8615	2-1/4"	57

Tap Wrenches & Die Stock Handle



Die Holder / Handles (Zinc)



- Range of die stock handles/ holders ,used for making external/internal threads .
- Round die inverted in die stock, to make clean cutting of external threads.
- Die holders have a rugged construction with heavy duty set screws that hold the die firmly in place.
- The inside screw , tighten to make thread on screw or rod larger.
- Tighten the two outside screws to make thread on rod narrower.
- Zinc die casted body with screws for tightening the dies.
- Chrome plated handles.

Item Code No.	Suitable for Die Size (mm)	Lenght (mm)
ABM-IMT-5900	20 x 5	200
ABM-IMT-5901	20 x7	220
ABM-IMT-5902	25 x 9	224
ABM-IMT-5903	30 x 11	280
ABM-IMT-5904	38 x 14	315

Die Holder / Handles (MS) (Round Die Stock Handle)



- For holding adjustable round split Dies.
- Made from Mild steel , Black Finish.
- Three Set Screws pattern.
- Single piece Construction.
- Die holders have a rugged construction with heavy duty set screws that hold the die firmly in place. The inside screw , tighten to make thread on screw or rod larger. Tighten the two outside screws to make thread on rod narrower.

Item Code No.	Outside Dia. of Die	Total Length
ABM-IMT-5930	5/8"	5-1/2"
ABM-IMT-5931	13/16"	6-1/2"
ABM-IMT-5932	1"	8-1/2"
ABM-IMT-5933	1-5/16"	10"
ABM-IMT-5934	1-1/2"	12"
ABM-IMT-5935	2"	15"
ABM-IMT-5936	2-1/2"	19"
ABM-IMT-5937	3"	22"
ABM-IMT-5938	3-1/2"	24"
ABM-IMT-5939	4"	29"
ABM-IMT-5940	5"	33"
ABM-IMT-5941	4 Pc Set consisting of 13/16", 1", 1-1/2" and 2"	

T. Tap Wrenches / Handle (Ratchet Type)

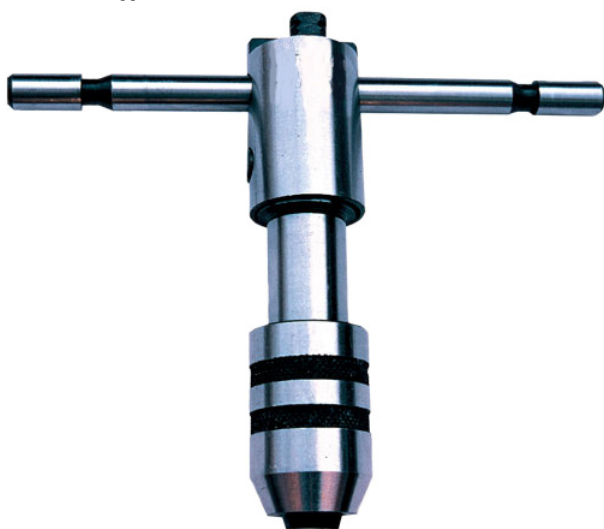

- Sliding T-Handle for fitting into tight spaces with greater leverage.
- Jaws are hardened and tempered, Jaws are replaceable.
- Shiny Ground Finish.
- Used in hand tapping.
- Can also be used with taps, reamers, screw extractors and other tools with a square shank.
- Ratchet action is reversible by changing the position of the upper knob.

Item Code No.	Tap Capacity Inch	Tap Capacity mm
ABM-IMT-5920	1/16" to 5/32"	1.5 to 4
ABM-IMT-5921	5/32" to 1/4"	4 to 6
ABM-IMT-5922	1/4" to 1/2"	6 to 12

Interchangeable Reversible Tap Wrench Holder Set



- Very Handy Tool Set which includes reversible ratchet mechanism.
- Consists of Two chucks and two handles 4" (100 mm) and 7" (175 mm) Long.
- Both Chucks and handles are interchangeable.
- Chrome plated Body.

Item Code No.	Chuck Range	
	Small Chuck Range	Big Chuck Range
ABM-IMT-5950	5/32" - 1/4"	1/4" - 1/2"

T. Tap Wrenches / Handle (Solid Jaws) (T Handle Tap Wrenches) (Standard Type)



- T handle tap wrenches , ideal for holding taps, reamers, screw extractors and other such small hand turned tools.
- T-handle tap wrench allows you to turn taps to help make screw threads.
- Fixed wrench has an extended shank for hard-to-reach tapping jobs.
- Fixed 'T' handle for tapping in open areas.
- Used in Hand Tapping.
- Can be used on other tools with a square head, such as screw extractors and reamers.
- Heavy knurled Cap for better grip.
- Ideal tool for general tapping application.

Item Code No.	Tap Capacity	
	Inch	mm
ABM-IMT-5960	1/16" to 5/32"	1.5 to 4
ABM-IMT-5961	5/32" to 1/4"	4 to 6
ABM-IMT-5962	3/16" to 5/16"	5 to 8
ABM-IMT-5963	1/4" to 1/2"	6 to 12
ABM-IMT-5964	Set of 3 Pcs consisting of ABM-IMT-5960, 5961, 5962	

T. Tap Wrenches / Handle (Replaceable Jaws)



- Tap wrenches , ideal for holding taps, reamers, screw extractors and other such small hand turned tools.
- These wrenches have sliding T handle friction ally held, that allows these tap wrenches used even in confined spaces.
- Jaws are hardened and tempered, Jaws are replaceable.
- Shiny Ground Finish.
- Used in hand tapping.
- Can also be used with drills and reamers.

Item Code No.	Tap Capacity	
	Inch	mm
ABM-IMT-5980	1/16" to 5/32"	1.5 to 4
ABM-IMT-5981	5/32" to 1/4"	4 to 6
ABM-IMT-5982	1/4" to 1/2"	6 to 12
ABM-IMT-5983	Set of 3 Pcs	Set of 3 Pcs

Piloted Spindle Tap Wrench

- Hardened and Tempered Replaceable Jaws.
- Tapping accessory for drill presses or lathes.
- Used for threading a drilled hole manually at one machine location, without moving the work piece
- Ensures identical centreline of the Tap and drilled hole.
- Can also be used as an ordinary Tap Wrench.



Item Code No.	Tap Capacity Inch	Square Size mm
ABM-IMT-5970	1/16" to 1/4"	3 - 5.0
ABM-IMT-5971	1/4" to 1/2"	5 - 7.0
ABM-IMT-5972	2 Pcs Set Consisting 1 each in a Box	



Extra Long T. Tap Wrenches



Standard Type



Ratchet Type



Replaceable Jaws

- Extra long tap wrenches are just what you need to tap those hard to reach holes. Wrenches have an extended shank for hard-to-reach tapping jobs.
- Fixed "T" handle for tapping in open areas. Adjust for right- or left-hand ratchet action, or lock in a non ratchet position.
- Hardened and Tempered Replaceable Jaws 6" (150 mm) Long, 9" (225 mm) & 12" (300 mm) .
- Shiny Ground Finish.
- Available in Solid Jaws, Replaceable Jaws and Ratchet Jaws.

Item Code No.	Type	Tap Capacity Inches	Square Size mm
ABM-IMT-5990	Solid Jaws	5/32 - 1/4	3 - 5.0
ABM-IMT-5991	Solid Jaws	1/4 - 1/2	5 - 7.0
ABM-IMT-5992	Replaceable Jaws	5/32 - 1/4	3 - 5.0
ABM-IMT-5993	Replaceable Jaws	1/4 - 1/2	5 - 7.0
ABM-IMT-5994	Ratchet Type	5/32 - 1/4	3 - 5.0
ABM-IMT-5995	Ratchet Type	1/4 - 1/2	5 - 7.0
ABM-IMT-5996	Solid Jaws	Set of 2 Pcs (One from Each Size)	
ABM-IMT-5997	Replaceable Jaws	Set of 2 Pcs (One from Each Size)	
ABM-IMT-5998	Ratchet Type	Set of 2 Pcs (One from Each Size)	



Tap Extensions



- The tap, supported by the close-fitting deep socket of the extension, held firmly in position by two socket set screws bearing 90° apart on the square of the tap.
- Eliminates need for expensive, hard to get extension taps.
- All steel construction with knurled grip chuck .
- The perfect option for reaching taps into pockets or the hub of a disc or wheel For taps.
- Attractive Finish.

Item Code No.	Tap Capacity Inch	Length	
		Inch	mm
ABM-IMT-6000	No. 0 to 12	7"	180 mm
ABM-IMT-6001	No. 12 to 1/2"	10-3/4"	275 mm
ABM-IMT-6002	2 Pcs Set Consisting 1 each in a Box		

Mini Tap Handle



- Handy Tapping tool.
- Ideal for Jeweller's, Watch Maker's and for small Tapping applications.
- They are ideal for small scale models, clocks, instruments, watches, business machines and much more.
- Can be used for a wide range of materials such as low carbon steels, stainless steel, copper, brass, aluminum, and plastics.

Item Code No.	Tap Capacity	
	Inch	mm
ABM-IMT-4573	1/4"	6 mm
ABM-IMT-4574	1/2"	12 mm
ABM-IMT-4575	2 Pc Set consisting of 1 each	

Adjustable Tap & Reamer Wrenches / Handles



- Double-end adjustable tap wrenches , also known as bar wrenches, have one threaded handle which is attached to one of the clamps.
- The clamp opened to insert the tool and then tightened down against the tool to secure it.
- This type of tap wrenches, used with larger taps and where there is room for a larger wrench.
- Hardened and tempered jaws.
- High Quality Tool for Hand Tapping Operation.
- Available in Zinc Casting Body, Drop Forged and MS casting Body.
- Small Sizes upto 1-1/8" available in Drop Forged Steel body and Large Size in Casting Body.
- Also Available in color Body and with Insulation Sleeves.

Zinc Die Casting Item Code No.	MS / Drop Forged Item Code no.	Tap Capacity		Total Length	
		Inch	mm	Inch	mm
ABM-IMT-6010	ABM-IMT-6015	1/16" to 1/4"	1.5 to 6	7"	175
ABM-IMT-6011	ABM-IMT-6016	1/16" to 3/8"	1.5 to 10	9"	225
ABM-IMT-6012	ABM-IMT-6017	5/32" to 1/2"	4 to 12	11"	275
ABM-IMT-6013	ABM-IMT-6018	5/32" to 3/4"	4 to 18	15"	375
--	ABM-IMT-6019	1/4" to 1-1/8"	6 to 27	19"	475
--	ABM-IMT-6020	3/4" to 1-1/2"	18 to 35	40"	1000
--	ABM-IMT-6021	1" to 2-1/2"	25 to 60	54"	1350
ABM-IMT-6014	--	3 Pc Die Cast Body Set Consisting ABM-IMT-6010 to ABM-IMT-6012			



Self Aligning Tap and Reamer Holder Tap and Reamer Aligner / Holder

- Hold tap and reamer true, preventing breakage.
- Hardened and replaceable jaws.
- Set consists of tapping guide, tap holder and jaw A for capacity 1/4" / M8 Tap and Jaw B for capacity 1/4" – 1/2" / M6 – M12 Tap.
- 85% Tap breakage eliminated
- Holds tool true-perfect alignment.
- Center drill or stem for floating center.

Item Code No.	Description
ABM-IMT-6025	Complete Set
ABM-IMT-6026	Set of Replacement Jaws (A + B)



Die Adapters

- Easily converts round die into hex dies.
- Just set the correct size die into adapter and tighten the screw.
- Great tool to use where conventional die stocks cannot swing due to lack of space.

Item Code No.	Size of Cutter
ABM-IMT-6739	13/16"
ABM-IMT-6740	1"
ABM-IMT-6741	1-1/2"
ABM-IMT-6742	2"
ABM-IMT-6743	2-1/2"
ABM-IMT-6744	3"
ABM-IMT-6745	Set of 4 pcs consisting of 13/16", 1", 1-1/2", 2"



T-Tap Wrench - Cam Lock

- Quality robust design T-Handle Tap Wrench for handling extreme torque, & principally based on a revolutionary cam lock system.
- Wide range of Tap holding capacity from 1/8" to 1/2" (M3 to M12) through a double size collet inside.
- Can also be used as a hand drill for sizes 1/8" – 5/16"

HOW TO USE :

1. Position the T-handle parallel to the body of the tap wrench.
2. Loosen the knurled nut, hold the desired tap & then re-tighten the nut again.
3. Reposition the T-handle 90° to the body as it was during first step, now the cam has locked the tap securely in place., which will never let the tap fall off while working.
4. To take out/ change the tap, just turn the T-handle parallel to the body as done in 1st step and the tap can be released easily.

Item Code No.
ABM-IMT-8820

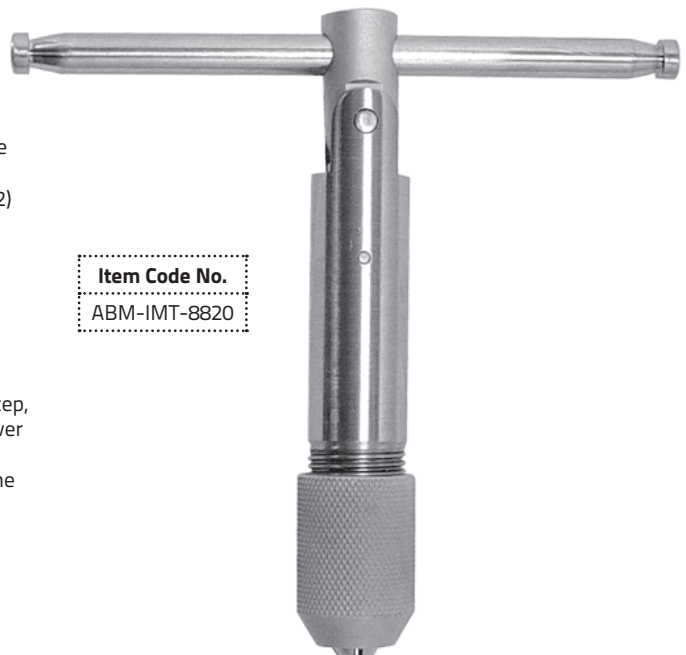

Tap Wrenches & Die Stock Handle

Large Capacity Tap Wrench

M4 to M20 Sturdy Tap Wrench

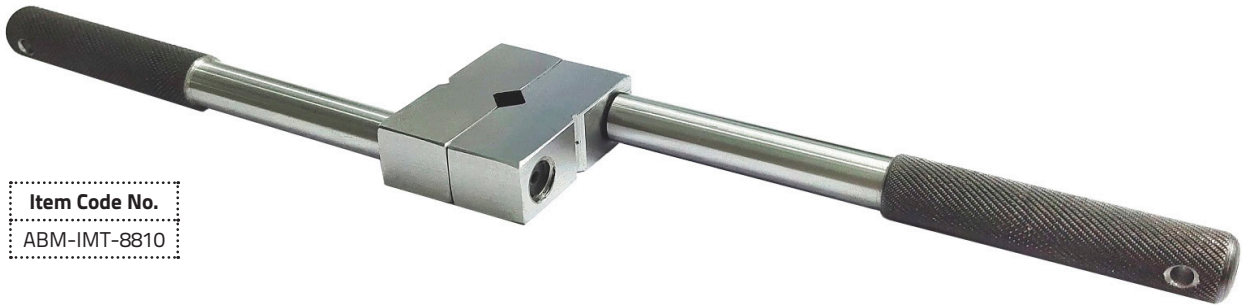

Item Code No.
ABM-IMT-8810

- Made of Quality Tool Steel
- Tap holding block (having v groove to hold taps) can be reversed to have different capacities of tap holding
- Block is hardened and Vee's are precision ground
- Knurled handle for a firm slip proof grip

Conduit Die Set



- Made from fine quality tool steel.
- Stocks & Dies made from high quality steel for longer life.

Item Code No.	Set Contents
ABM-IMT-8260	M20, M25
ABM-IMT-8261	M20, M25 & M32



Tool Holders & Boring Bars



Die Holder (Shank Type)



- Ideal for short or medium run threading of shafts.
- Can be used safely on Lathe Milling Machine and Tapping heads.
- Single piece construction.
- Shank Length 2" (50 mm). Body Length 1" (25.4 mm).
- Available with and without Round Die.

Item Code No.	Die Size		Shank Diameter		Body Diameter	
	Inch	mm	Inch	mm	Inch	mm
ABM-IMT-6430	13/16"	20	1/2"	12.7	1-1/2"	38
ABM-IMT-6431	1"	25	1/2"	12.7	1-1/2"	38
ABM-IMT-6432	1-1/2"	38	3/4"	19	2"	50
ABM-IMT-6433	2 Pc Set consisting of 13/16" (20 mm) and 1" (25 mm)					
ABM-IMT-6434	3 Pc Set consisting of 13/16" (20 mm), 1" (25 mm) and 1-1/2" (38 mm)					

Die Holder - Straight Shank



- Knurling is provided on the outer body of the holder to ease the operation by hands.
- Die holder include a straight shank for hand operations as well as for machines.

Item Code No.	Shank	Die Capacity
ABM-IMT-6425	10 mm	25 mm

Tail Stock Die Holder Set



- Double Ended Die Holder For 13/16" (20mm) & 1" (25mm) Circular Dies.
- Has MT-2 Shank.
- Guide Pin For Torque For Larger Threaded sizes.
- Aluminium Die Holder Body.
- Hardened & Grounded Shank.

Item Code No.	Size
ABM-IMT-8295	Metric
ABM-IMT-8296	Imperial

Tail Stock Die Holder Set



- Available in Metric and Imperial Sizes.
- Packed in attractive Wooden Box.
- Set of 2 Dies and 4 Dies.

Item Code No. Metric	Morse Taper	Die Holders
ABM-IMT-6073	MT1	20 & 25 mm
ABM-IMT-6074	MT2	20, 25, 30 & 38 mm
ABM-IMT-6075	MT3	20, 25, 30 & 38 mm

Item Code No. Imperial	Morse Taper	Die Holders
ABM-IMT-6076	MT1	3/16" , 1"
ABM-IMT-6077	MT2	3/16" , 1" , 1-5/16" , 1-1/2"
ABM-IMT-6078	MT3	3/16" , 1" , 1-5/16" , 1-1/2"

Floating Tail Stock Die Holder Set

- Available in Metric and Imperial Sizes.
- Packed in attractive Wooden Box.
- Set consists of Pin Punch to knock the pin out.
- Tail Stock Holder set consists of Taper Shank & 4 Die holders.
- Completely interchangeable to fit tapered shank with the help of a pin which allows about 1-1/2" travel

Item Code No. Metric	Morse Taper	Die Holders
ABM-IMT-6068	MT2	20, 25, 30 & 38 mm
ABM-IMT-6069	MT3	20, 25, 30 & 38 mm

Item Code No. Imperial	Morse Taper	Die Holders
ABM-IMT-6070	MT2	3/16", 1", 1-5/16", 1-1/2"
ABM-IMT-6071	MT3	3/16", 1", 1-5/16", 1-1/2"



Face Mill Cutters - APKT Inserts

- Good impact resistance and Durable in use.
- High strength and hardness.
- The rotary and milling feed rates 3 times more than normal milling cutter.
- Processing range: roughing, plane processing, groove cut, side processing, stairs processing.
- Ideal tool for heavy CNC milling cutting.

Item Code No.	No. of Flutes	Dia. mm	Tool Holding Bore - mm	Height mm	Insert
ABM-IMT-8190	6	40	16	40	APKT 100305
ABM-IMT-8191	6	50	22	40	APKT 100305
ABM-IMT-8192	6	63	22	40	APKT 100305
ABM-IMT-8193	6	80	27	50	APKT 100305
ABM-IMT-8194	6	100	32	50	APKT 100305



Fly Cutter Tool Holder Taper Shank

- A fly cutter usually has two cutting heads and it is able to cut with a constant depth to face any surface to obtain a uniform surface.
- Fly cutters are used in automobile industry for various facing jobs.
- In motor industry fly cutters are used extensively.
- In almost all occasions they are used for the facing.

Item Code No.	Description	Style	Drawbar
ABM-IMT-8500	Metric	MT2	M10
ABM-IMT-8501	Metric	MT3	M12
ABM-IMT-8502	Inches	MT2	3/8" BSW
ABM-IMT-8503	Inches	MT3	1/2" BSW
ABM-IMT-8504	Inches	R8	7/16" UNF



Tool Holders & Boring Bars



Fly Cutter



- For Round Tool Bit also available separately.
- Set of 3 Pcs packed in plastic pouch plus 3 Cutting bits.
- Very handy milling machine tools.
- Quality hard wearing fly cutters.

Item Code No.	Head Dia.		Shank Dia.		Tool Bit Size	
	Inch	mm	Inch	mm	Inch	mm
ABM-IMT-6450	9/16"	14	3/8"	10	1/4"	6
ABM-IMT-6451	3/4"	19	3/8"	10	5/16"	8
ABM-IMT-6452	7/8"	22	3/8"	10	3/8"	10
ABM-IMT-6453	3 Pcs above Size with Suitable Tool Bits					

R-8 Fly Cutter Holder



- Counter balanced to get smoother finishes.
- Made from Hardened Steel.

Item Code No.	Head Dia.		Suitable for Tool Bit Size	
	Inch	mm	Inch	mm
ABM-IMT-6455	2-1/2"	63.5	5/16"	8

Fly Tool Cutter Holder

- Fly cutter set, used primarily on a milling machine for machining large, flat surface areas.
- The fly cutter is a single-point cutting tool similar to a lathe tool mounted in a special holder.
- Counter balanced to get smoother finish.
- Shiny Black Finish.
- Sets supplied on wood stand.
- Supplied with and without Tool Bit.



Item Code No.	Head Dia. Inch	Shank size Inch	Holding Size of Bit
ABM-IMT-6470	3/4"	1/2"	3/16"
ABM-IMT-6471	1-1/8"	1/2"	1/4"
ABM-IMT-6472	1-1/2"	1/2"	5/16"
ABM-IMT-6473	1-1/4"	3/4"	5/16"
ABM-IMT-6474	1-1/2"	3/4"	5/16"
ABM-IMT-6475	2"	3/4"	5/16"
ABM-IMT-6476	2-1/2"	3/4"	5/16"
ABM-IMT-6477	2-1/2"	3/4"	3/8"
ABM-IMT-6478	2-1/2"	R8	3/8"
ABM-IMT-6479	2"	R8	5/16"
ABM-IMT-6480	2"	MT2	5/16"
ABM-IMT-6481	2"	MT3	5/16"
ABM-IMT-6482	3 Pcs Set ABM-IMT-6470 to 6472		
ABM-IMT-6483	3 Pcs Set ABM-IMT-6473 to 6475		
ABM-IMT-6484	5 Pcs Set Consists of 4 pcs with 1/2" (12.7 mm) shank suitable for 3/16" (4.50 mm), 1/4" (6 mm), 5/16" (8 mm), 3/8" (9.5 mm) tool bits and 1 pc with 5/8" (15.8 mm) shank suitable for 1/2" (12.7 mm) tool bits		

Indexable Carbide Turning Tool Holder Set of 5 Pcs.

Indexable Carbide Turning Tool Holder (Set of 5 Pcs).

- Versatile of Cutting in any direction.
- Built in Chip Breaker Groove.
- Ready to Use. No Grinding. No Tool Resetting.
- Heat treated and hardened shank
- Economical alternative to Brazed Tool Tip.
- Supplied with and without inserts.

Set Consist of following (5 Pcs Set)

- Style TE: Neutral Threading Tool 60 degree included angle; used for universal threading,
- V-grooving, Chamfering, turning, boring & facing
- Style TBL: Left Hand 15 degree lead angle for rough facing to center or where no shoulder is needed
- Style TAL: Left Hand suitable for facing to a square shoulder
- Style TBR: Right Hand 15 degree lead angle for rough turning where a square shoulder is not needed

Item Code No.	Size of Square Shank	Insert IC	Style	Overall Length
ABM-IMT-6230	3/8"	1/4"	TE-6	2-1/2"
ABM-IMT-6231	3/8"	1/4"	TBL-6	2-1/2"
ABM-IMT-6232	3/8"	1/4"	TAL-6	2-1/2"
ABM-IMT-6233	3/8"	1/4"	TBR-6	2-1/2"
ABM-IMT-6234	3/8"	1/4"	TAR-6	2-1/2"
ABM-IMT-6235	Set of Five Holders with 3/8" shank			
ABM-IMT-6236	1/2"	3/8"	TE-8	3-1/2"
ABM-IMT-6237	1/2"	3/8"	TBL-8	3-1/2"
ABM-IMT-6238	1/2"	3/8"	TAL-8	3-1/2"
ABM-IMT-6239	1/2"	3/8"	TBR-8	3-1/2"
ABM-IMT-6240	1/2"	3/8"	TAR-8	3-1/2"
ABM-IMT-6241	Set of Five Holders with 1/2" shank			
ABM-IMT-6242	5/8"	3/8"	TE-10	4"
ABM-IMT-6243	5/8"	3/8"	TBL-10	4"
ABM-IMT-6244	5/8"	3/8"	TAL-10	4"
ABM-IMT-6245	5/8"	3/8"	TBR-10	4"
ABM-IMT-6246	5/8"	3/8"	TAR-10	4"
ABM-IMT-6247	Set of Five Holders with 5/8" shank			
ABM-IMT-6248	3/4"	3/8"	TE-12	4-1/2"
ABM-IMT-6249	3/4"	3/8"	TBL-12	4-1/2"
ABM-IMT-6250	3/4"	3/8"	TAL-12	4-1/2"
ABM-IMT-6251	3/4"	3/8"	TBR-12	4-1/2"
ABM-IMT-6252	3/4"	3/8"	TAR-12	4-1/2"
ABM-IMT-6253	Set of Five Holders with 3/4" shank			
ABM-IMT-6254	1"	1/2"	TE-16	6"
ABM-IMT-6255	1"	1/2"	TBL-16	6"
ABM-IMT-6256	1"	1/2"	TAL-16	6"
ABM-IMT-6257	1"	1/2"	TBR-16	6"
ABM-IMT-6258	1"	1/2"	TAR-16	6"
ABM-IMT-6259	Set of Five Holders with 1" shank			



Tool Holders & Boring Bars



Indexable Carbide Turning Tool Holder Set of 7 Pcs.



- Versatile of Cutting in any direction.
- Built in Chip Breaker Groove.
- Ready to Use. No Grinding. No Tool Resetting.
- Heat treated and hardened shank
- Economical alternative to Brazed Tool Tip.
- Turning Tool Holder with indexable insert of Carbide Metal quality.
- Have four cutting edges insert shape CCMT.
- Set of 7 Pcs with Key.
- Supplied with and without inserts.

Set Consist of following (7 Pcs Set)

Left Hand Turning Tool – for Straight turning – 1 Piece

Right Hand Turning Tool – for Straight turning – 1 Piece

Right Hand Facing Tool – for Face turning – 1 Piece

Right Hand Straight Turning Tool – for Straight turning – 1 Piece

Pointed Turning Tool – for outside thread turning and straight turning – 1 Piece

Off Pointed Turning Tool – for outside thread turning and straight turning – 1 Piece

Boring Bar for right hand cutting – for turning out internal bores – 1 Piece

Item Code No.	Shank Size mm	Suitable Carbide Insert
ABM-IMT-6060	6	CCMT 060204
ABM-IMT-6061	8	CCMT 060204
ABM-IMT-6062	10	CCMT 060204
ABM-IMT-6063	12	CCMT 060204
ABM-IMT-6064	16	CCMT 060204

Boring Tool Holders (Lever Lock) (A)



- PCLNR/L 95° Approach.
- For negative 80° Rhombic Inserts.

Item Code No.	As Per ISO Designation	Suitable Inserts
ABM-IMT-6120	S25T PCLNR 12	CN_A, CN_G & CN_M
ABM-IMT-6121	S25T PCLNL 12	CN_A, CN_G & CN_M
ABM-IMT-6122	S32U PCLNR 12	CN_A, CN_G & CN_M
ABM-IMT-6123	S32U PCLNL 12	CN_A, CN_G & CN_M
ABM-IMT-6124	S40V PCLNR 12	CN_A, CN_G & CN_M
ABM-IMT-6125	S40V PCLNL 12	CN_A, CN_G & CN_M
ABM-IMT-6126	S50W PCLNR 16	CN_A, CN_G & CN_M
ABM-IMT-6127	S50W PCLNL 16	CN_A, CN_G & CN_M
ABM-IMT-6128	S50W PCLNR 19	CN_A, CN_G & CN_M

Boring Tool Holders (Lever Lock) (B)



- PSKNR/L 95° Approach.
- For negative Square Inserts.

Item Code No.	As Per ISO Designation	Suitable Inserts
ABM-IMT-6140	S25T PSKNR 12	SN_A, SN_G & SN_M
ABM-IMT-6141	S25T PSKNL 12	SN_A, SN_G & SN_M
ABM-IMT-6142	S32U PSKNR 12	SN_A, SN_G & SN_M
ABM-IMT-6143	S32U PSKNL 12	SN_A, SN_G & SN_M
ABM-IMT-6144	S40V PSKNR 19	SN_A, SN_G & SN_M

Boring Tool Holders (Screw ON)

(A)



- SCLCR/L 95° Approach.
- For 7° Positive 80° Rhombic Inserts.

Item Code No.	As Per ISO Designation	Suitable Inserts
ABM-IMT-6190	S08K SCLCR 06	CC_G, CC_M & CC_T
ABM-IMT-6191	S08K SCLCL 06	CC_G, CC_M & CC_T
ABM-IMT-6192	S10M SCLCR 06	CC_G, CC_M & CC_T
ABM-IMT-6193	S10M SCLCL 06	CC_G, CC_M & CC_T
ABM-IMT-6194	S12M SCLCR 06	CC_G, CC_M & CC_T
ABM-IMT-6195	S12Q SCLCR 09	CC_G, CC_M & CC_T
ABM-IMT-6196	S12Q SCLCL 09	CC_G, CC_M & CC_T
ABM-IMT-6197	S16R SCLCR 09	CC_G, CC_M & CC_T
ABM-IMT-6198	S16R SCLCR 09	CC_G, CC_M & CC_T
ABM-IMT-6199	S20S SCLCR 09	CC_G, CC_M & CC_T
ABM-IMT-6200	S20S SCLCL 09	CC_G, CC_M & CC_T
ABM-IMT-6201	S25T SCLCR 09	CC_G, CC_M & CC_T

Boring Tool Holders (Screw ON)

(B)



- SCLCR/L 95° Approach.
- For 7° Positive 80° Rhombic Inserts.

Item Code No.	As Per ISO Designation	Suitable Inserts
ABM-IMT-6211	S12Q SDUCR 07	DC_T & DC_W
ABM-IMT-6212	S12Q SDUCL 07	DC_T & DC_W
ABM-IMT-6213	S16R SDUCR 07	DC_T & DC_W
ABM-IMT-6214	S16R SDUCL 07	DC_T & DC_W
ABM-IMT-6215	S20S SDUCR 07	DC_T & DC_W
ABM-IMT-6216	S20S SDUCL 07	DC_T & DC_W
ABM-IMT-6217	S20S SDUCR 11	DC_T & DC_W
ABM-IMT-6218	S20S SDUCL 11	DC_T & DC_W
ABM-IMT-6219	S25T SDUCR 11	DC_T & DC_W
ABM-IMT-6220	S25T SDUCL 11	DC_T & DC_W

External Tool Holders (Lever Lock)

(A)



- PCKNRR/L 75° Approach.
- For Negative 80° Rhombic Inserts.

Item Code No.	As Per ISO Designation	Suitable Inserts
ABM-IMT-6270	PCKNR 2020K 12	CN_A, CN_G & CN_M
ABM-IMT-6271	PCKNR 2525M 12	CN_A, CN_G & CN_M
ABM-IMT-6272	PCKNL 2525M 12	CN_A, CN_G & CN_M
ABM-IMT-6273	PCKNR 3225P 12	CN_A, CN_G & CN_M
ABM-IMT-6274	PCKNL 3225P 12	CN_A, CN_G & CN_M

External Tool Holders (Lever Lock)

(B)



- PCLNR/L 95° Approach.
- Approach For Negative 80° Rhombic Inserts.

Item Code No.	As Per ISO Designation	Suitable Inserts
ABM-IMT-6275	PCLNR 1616H 12	CN_A, CN_G & CN_M
ABM-IMT-6276	PCLNL 1616H 12	CN_A, CN_G & CN_M
ABM-IMT-6277	PCLNR 2020K 12	CN_A, CN_G & CN_M
ABM-IMT-6278	PCLNL 2020K 12	CN_A, CN_G & CN_M
ABM-IMT-6279	PCLNR 2525M 12	CN_A, CN_G & CN_M
ABM-IMT-6280	PCLNL 2525M 12	CN_A, CN_G & CN_M
ABM-IMT-6281	PCLNR 2525M 16	CN_A, CN_G & CN_M
ABM-IMT-6282	PCLNL2525M 16	CN_A, CN_G & CN_M
ABM-IMT-6283	PCLNR 2525M 19	CN_A, CN_G & CN_M
ABM-IMT-6284	PCLNL 2525M 19	CN_A, CN_G & CN_M
ABM-IMT-6285	PCLNR 3225P 12	CN_A, CN_G & CN_M
ABM-IMT-6286	PCLNL 3225P 12	CN_A, CN_G & CN_M
ABM-IMT-6287	PCLNR 3225P 16	CN_A, CN_G & CN_M
ABM-IMT-6288	PCLNL 3225P 16	CN_A, CN_G & CN_M
ABM-IMT-6289	PCLNR 3232P 19	CN_A, CN_G & CN_M
ABM-IMT-6290	PCLNL 3232P 19	CN_A, CN_G & CN_M

Tool Holders & Boring Bars



External Tool Holders (Screw Clamp)

(A)



- SDJCR/L 93° Approach.
- For 7° Positive 55° Rhombic Inserts.

Item Code No.	As Per ISO Designation	Suitable Inserts
ABM-IMT-6300	SDNCN 0808D 07	DC_A, DC_G & DC_M
ABM-IMT-6301	SDNCN 1010E 07	DC_A, DC_G & DC_M
ABM-IMT-6302	SDNCN 1212F 07	DC_A, DC_G & DC_M
ABM-IMT-6303	SDNCN 1616H 11	DC_A, DC_G & DC_M
ABM-IMT-6304	SDNCN 2020K 11	DC_A, DC_G & DC_M
ABM-IMT-6305	SDNCN2525M 11	DC_A, DC_G & DC_M

External Tool Holders (Screw Clamp)

(C)



- SDJCR/L 93° Approach.
- For 7° Positive 55° Rhombic Inserts.

Item Code No.	As Per ISO Designation	Suitable Inserts
ABM-IMT-6350	SRDCN 1010E 06	RC_M, RC_A & RC_T
ABM-IMT-6351	SRDCN 1212F 06	RC_M, RC_A & RC_T
ABM-IMT-6352	SRDCN 1616H 06	RC_M, RC_A & RC_T
ABM-IMT-6353	SRDCN 1616H 08	RC_M, RC_A & RC_T
ABM-IMT-6354	SRDCN 2020K 06	RC_M, RC_A & RC_T
ABM-IMT-6355	SRDCN 2020K 08	RC_M, RC_A & RC_T
ABM-IMT-6356	SRDCN 2525M 06	RC_M, RC_A & RC_T
ABM-IMT-6357	SRDCN 2525M 08	RC_M, RC_A & RC_T

External Tool Holders (Screw Clamp)

(B)

- SDNCN 62.5° Approach.
- For 7° Positive 55° Rhombic Inserts.

Item Code No.	As Per ISO Designation	Suitable Inserts
ABM-IMT-6310	SDJCR 1010E 07	DC_A, DC_G & DC_M
ABM-IMT-6311	SDJCL 1010E 07	DC_A, DC_G & DC_M
ABM-IMT-6312	SDJCR 1212F 07	DC_A, DC_G & DC_M
ABM-IMT-6313	SDJCL 1212F 07	DC_A, DC_G & DC_M
ABM-IMT-6314	SDJCR 1212F 11	DC_A, DC_G & DC_M
ABM-IMT-6315	SDJCL 1212F 11	DC_A, DC_G & DC_M
ABM-IMT-6316	SDJCR 1616H 07	DC_A, DC_G & DC_M
ABM-IMT-6317	SDJCL 1616H 07	DC_A, DC_G & DC_M
ABM-IMT-6318	SDJCR 1616H 11	DC_A, DC_G & DC_M
ABM-IMT-6319	SDJCL 1616H 11	DC_A, DC_G & DC_M
ABM-IMT-6320	SDJCR 2020K 11	DC_A, DC_G & DC_M
ABM-IMT-6321	SDJCL 2020K 11	DC_A, DC_G & DC_M
ABM-IMT-6322	SDJCR 2525M 11	DC_A, DC_G & DC_M
ABM-IMT-6323	SDJCL 2525M 11	DC_A, DC_G & DC_M

External Tool Holders (Screw Clamp)

(D)

- SRGCR/L 90° Approach.
- For 7° Positive Round Inserts.

Item Code No.	As Per ISO Designation	Suitable Inserts
ABM-IMT-6370	SRGCR 1010E 06	RC_T, RC_A & RC_M
ABM-IMT-6371	SRGCL 1010E 06	RC_T, RC_A & RC_M
ABM-IMT-6372	SRGCR 1212F 06	RC_T, RC_A & RC_M
ABM-IMT-6373	SRGCL 1212F 06	RC_T, RC_A & RC_M
ABM-IMT-6374	SRGCR 1616H 06	RC_T, RC_A & RC_M
ABM-IMT-6375	SRGCL 1616H 06	RC_T, RC_A & RC_M
ABM-IMT-6376	SRGCR 1616H 08	RC_T, RC_A & RC_M
ABM-IMT-6377	SRGCL 1616H 08	RC_T, RC_A & RC_M
ABM-IMT-6378	SRGCR 2020K 06	RC_T, RC_A & RC_M
ABM-IMT-6379	SRGCL 2020K 06	RC_T, RC_A & RC_M
ABM-IMT-6380	SRGCR 2020K 08	RC_T, RC_A & RC_M
ABM-IMT-6381	SRGCL 2020K 08	RC_T, RC_A & RC_M
ABM-IMT-6382	SRGCR 2525M 06	RC_T, RC_A & RC_M
ABM-IMT-6383	SRGCL 2525M 06	RC_T, RC_A & RC_M
ABM-IMT-6384	SRGCR 2525M 08	RC_T, RC_A & RC_M
ABM-IMT-6385	SRGCL 2525M 08	RC_T, RC_A & RC_M

External Tool Holders (Top Clamp)

(A)



- CSBPR/L 75° Approach.
- For 11° Positive Square Inserts.

Item Code No.	As Per ISO Designation	Suitable Inserts
ABM-IMT-6400	CKNJR 2525M 16	KN_X
ABM-IMT-6401	CKJNL 2525M 16	KN_X
ABM-IMT-6402	CKJNR 3225P 16	KN_X
ABM-IMT-6403	CKJNL 3225P 16	KN_X

External Tool Holders (Top Clamp)

(B)



- CSBPR/L 75° Approach.
- For 11° Positive Square Inserts.

Item Code No.	As Per ISO Designation	Suitable Inserts
ABM-IMT-6410	CSBPR 1616H 09	SP_R & SP_N
ABM-IMT-6411	CSBPR 2020K 12	SP_R & SP_N
ABM-IMT-6412	CSBPL 2020K 12	SP_R & SP_N
ABM-IMT-6413	CSBPR 2525M 12	SP_R & SP_N
ABM-IMT-6414	CSBPL 2525M 12	SP_R & SP_N

External Tool Holders (Top Clamp)

(C)

- CSDPN 45° Approach.
- For 11° Positive Square Inserts.

Item Code No.	As Per ISO Designation	Suitable Inserts
ABM-IMT-6420	CSDPN 1616H 09	SP_R & SP_N
ABM-IMT-6421	CSDPN 2020K 12	SP_R & SP_N
ABM-IMT-6422	CSDPN 2525M 12	SP_R & SP_N

Double Ended Boring Bars

(Available with and without Holders)



Boring Bars with Holder



Boring Bars without Holder

Holder

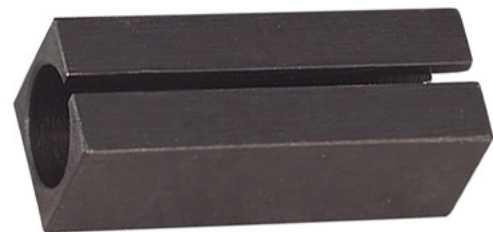

- Double Ended one piece boring bars have 90° & 45° square ends.
- Set Supplied with Boring Bar, Holder, Allen Key and Screw.
- Tool Bits also available on extra cost.
- Shiny black finish.
- Available with and without Holders.
- Only Holder and only Boring Bar also available separately.
- Single Ended Boring Bars also available.

Set Item Code No.	Bar Size		Holder Size		Square Bit Size
	Dia.	Length	Length	Square	
ABM-IMT-6100	3/8"	4-1/2"	2-1/8"	1/2"	1/8"
ABM-IMT-6101	7/16"	5-1/4"	2-1/2"	5/8"	3/16"
ABM-IMT-6102	9/16"	6-3/4"	3"	3/4"	1/4"
ABM-IMT-6103	3/4"	9"	3-3/4"	1"	5/16"
ABM-IMT-6104	7/8"	11-1/2"	4-1/2"	1-1/8"	3/8"
ABM-IMT-6105	1-1/8"	14"	5"	1-3/8"	7/16"
ABM-IMT-6106	1-1/4"	15"	5-1/4"	1-5/8"	1/2"
ABM-IMT-6107	1-3/8"	16"	6"	1-3/4"	5/8"
ABM-IMT-6108	1-1/2"	18"	6"	2"	3/4"
ABM-IMT-6109	2"	20"	7"	3"	1"

Tool Holders & Boring Bars



Double Ended Boring Bar Sets

- Double Ended one piece boring bars have 90° & 45° square ends.
- Set Supplied with Boring Bar, Holder, Allen Key and Screw.
- Tool Bits also available on extra cost.
- Shiny black finish.
- Sets with Fine Wooden Stand.
- Single Ended Boring Bars also available.



Complete Set Item Code No.	Bar Size		Holder Size		Square Bit Size
	Dia.	Length	Length	Square	
ABM-IMT-6130	3/8"	4-1/2"	2-1/8"	1/2"	1/8"
ABM-IMT-6131	7/16"	5-1/4"	2-1/2"	5/8"	3/16"
ABM-IMT-6132	9/16"	6-3/4"	3"	3/4"	1/4"
ABM-IMT-6133	3/4"	9"	3-3/4"	1"	5/16"
ABM-IMT-6134	7/8"	11-1/2"	4-1/2"	1-1/8"	3/8"
ABM-IMT-6135	1-1/8"	14"	5"	1-3/8"	7/16"
ABM-IMT-6136	1-1/4"	15"	5-1/4"	1-5/8"	1/2"
ABM-IMT-6137	1-3/8"	16"	6"	1-3/4"	5/8"
ABM-IMT-6138	1-1/2"	18"	6"	2"	3/4"
ABM-IMT-6139	2"	20"	7"	3"	1"

Lathe Boring Tools

- Made from special Steel and accurately machined.
- Individually Boxed, Contains Holder and One Double Ended Boring Bar.
- Tools Bits not included. Tool Bits also available on extra cost.
- Black Shining Finish.

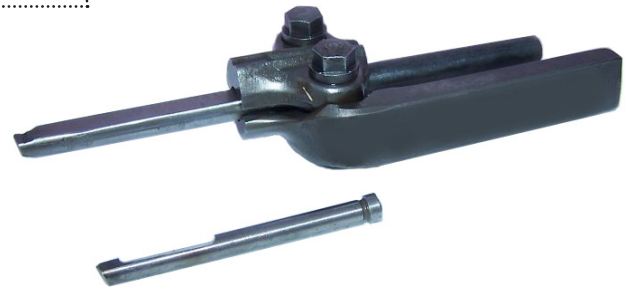

Item Code No.	Diameter of Bar	Overall Length	Bit Size
ABM-IMT-6150	MT 1	5/16" x 5/8" x 4-1/2"	3/16"
ABM-IMT-6151	MT 2	3/8" x 7/8" x 5-3/8"	3/16"
ABM-IMT-6152	MT 3	1/2" x 1-1/8" x 6-1/8"	1/4"
ABM-IMT-6153	MT 4	5/8" x 1-3/8" x 7-7/16"	5/16"

Boring Tool Holder - Heavy Duty

Ideal for boring internal diameters, threading, turning metals such as brass, aluminium, steel, copper, etc.



Item Code No.	Diameter of Bar	Holder Size	Tool Bit Size	For Lathes Swing
ABM-IMT-6160	1/2"	5/16" x 3/4" x 4-7/8"	3/16" Square	6 - 8
ABM-IMT-6161	9/16"	3/8" x 7/8" x 5-3/8"	3/16" Square	9 - 10
ABM-IMT-6162	3/4"	1/2" x 1-1/8" x 6-1/8"	1/4" Square	11 - 14
ABM-IMT-6163	15/16"	5/8" x 1-3/8" x 7-7/16"	5/16" Square	14 - 16

Calibrated Boring Bars



- Suitable for use on both ends
- Corrosion resistance
- Dimensional accuracy
- Durable finish standards
- Permanently graduated bars at 1/4" calibration to speed up the production while indicating the depth of bore
- Supplied with Allen key but without tool bits
- Assures firm clamping with all kinds of holders
- Highly precise and sharp edges to ensure smoother cuts
- Easy to insert and replace
- High resistance towards crack, bending, abrasion and chips
- Ideal for boring, reaming, cutting as well as drilling operations
- High precision and strong rigidity for accurate operations

Set Item Code No.	Boring Bar Size		Bit Size
	Dia.	Length	
ABM-IMT-6170	3/8"	6"	3/16" Round
ABM-IMT-6171	1/2"	9"	1/4" Square
ABM-IMT-6172	5/8"	10"	1/4" Square
ABM-IMT-6173	3/4"	12"	1/4" Square
ABM-IMT-6174	1"	12"	5/16" Square

Indexable End Mills

ST & MT Shanks



- Supplied with 2 Fitted Inserts, Screws & Wrench
- Manufactured from High Grade Steel
- Excellent Tool for facing off excessive material quickly ensuring smooth and even finish.

MT Shank Item Code No.	Shank	Head Dia.	No of Flutes	DrawBar
ABM-IMT-8130	MT2	25 mm	2	M10
ABM-IMT-8131	MT3	32 mm	2	M12

Straight Shank Item Code No.	Shank	Shank Dia.	Head Dia.	No. of Flutes
ABM-IMT-8135	Straight	20 mm	25 mm	2
ABM-IMT-8136	Straight	20 mm	32 mm	2

Indexable End Mills

APKT Inserts



- Supplied with 2 Fitted Inserts, Screws & Wrench
- Manufactured from High Grade Steel
- Excellent Tool for facing off excessive material quickly ensuring smooth and even finish.

Item Code No.	No. of Flutes	Shank	Head Dia.	Insert	Draw-bar
ABM-IMT-8170	3	MT2	20	APKT 100305	M10
ABM-IMT-8171	3	MT2	25	APKT 100305	M10
ABM-IMT-8172	3	MT3	25	APKT 100305	M12
ABM-IMT-8173	3	MT3	40	APKT 100305	M12

Indexable End Mills

TPKN Inserts



- Supplied with 2 Fitted Inserts, Screws & Wrench
- Manufactured from High Grade Steel
- Excellent Tool for facing off excessive material quickly ensuring smooth and even finish.

Item Code No.	No. of Flutes	Shank	Head Dia.	Insert	Drawbar
ABM-IMT-8145	2	R8	30	TPKN1603	7/16"UNF
ABM-IMT-8146	2	MT2	25	TPKN1603	M10
ABM-IMT-8147	2	MT3	30	TPKN1603	M12
ABM-IMT-8148	2	20 mm ST.	25	TPKN1603	--
ABM-IMT-8149	2	20 mm ST.	32	TPKN1603	--
ABM-IMT-8150	3	MT2	50	TPKN1603	M10
ABM-IMT-8151	3	MT3	50	TPKN1603	M12
ABM-IMT-8152	3	MT3	60	TPKN1603	M12
ABM-IMT-8153	3	ISO30	50	TPKN1603	M12
ABM-IMT-8154	3	ISO30	60	TPKN1603	M12

Tool Holders & Boring Bars



Round Tool Holders Double Ended



- A useful Tool to Hold Round Tool Steel.
- One Holder Allows two Different Sizes of Round Steel to Hold.

Item Code No.	Suitable for Tool Dia	Holder Size
ABM-IMT-8490	5 & 6 mm	8 x 8 x 60 mm
ABM-IMT-8491	8 & 10 mm	12 x 12 x 80 mm
ABM-IMT-8492	10 & 12 mm	20 x 20 x 110 mm

Turning Tool Bit Holder (English / British Pattern)



- Accurately Machined.
- Heat Treated & Hardened.
- Provided with one Wrench.
- Supplied with and without Tool Bits.
- Available in ST (Straight), LT (Left) and RT (Right) Hand Shanks.
- Please specify ST, LT or RT with order.

Item Code No.	Size of Holder	Size of Cutter
ABM-IMT-6690	7/16" x 9/4" x 4-1/2"	1/8"
ABM-IMT-6691	1/2" x 9/16" x 4-1/2"	3/16"
ABM-IMT-6692	5/8" x 3/4" x 7-1/2"	1/4"
ABM-IMT-6693	3/4" x 7/8" x 8-1/2"	5/16"
ABM-IMT-6694	7/8" x 1" x 9-1/2"	3/8"
ABM-IMT-6695	1" x 1-1/8" x 10-1/2"	7/16"
ABM-IMT-6696	1-1/8" x 1-1/4" x 11-1/2"	1/2"

Please specify ST, LT or RT while placing order

Turning Tool Bit Holder (American Pattern)

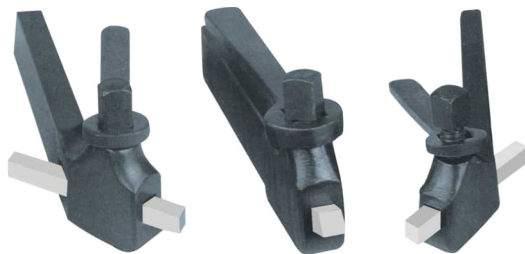

- Accurately Machined.
- Heat Treated & Hardened.
- Provided with one Wrench.
- Supplied with and without Tool Bits.
- Available in ST (Straight), LT (Left) and RT (Right) Hand Shanks.
- Please specify ST, LT or RT with order.
- Also available Turning Tool Bit Holder for Carbide Bit Holder.

Item Code No.	Size of Holder		Size of Cutter	
	Inch	mm	Inch	mm
ABM-IMT-6660	5/16 x 3/4 x 4-1/2	8 x 19 x 114	3/16	4.76
ABM-IMT-6661	3/8 x 7/8 x 5	9.5 x 22 x 127	1/4	6.35
ABM-IMT-6662	1/2 x 1-1/8 x 6	13 x 28 x 152	5/16	7.93
ABM-IMT-6663	5/8 x 1-3/8 x 7	16 x 35 x 178	3/8	9.52
ABM-IMT-6664	3/4 x 1-5/8 x 8	19 x 41 x 203	7/16	11.11
ABM-IMT-6665	7/8 x 1-3/4 x 9	22 x 44 x 228	1/2	12.7
ABM-IMT-6666	1 x 2 x 11	25 x 50 x 280	5/8	15.87
ABM-IMT-6667	1-1/4 x 2-1/4 x 13	32 x 57 x 330	3/4	19.05

Please specify ST, LT or RT while placing order

Turning Tool Bit Holder (Adjustable)



- Supplied with and without Tool Bits.
- This tool can be used for the mini lathe and standard lathe machines to hold HSS Tool Bits.
- The holders are made of steel hardened, machined and precision ground from the top and bottom.
- The holders are adjustable and can hold two different sizes of the tool bits with a rigid secure clamping.
- Holder supplied with Allen Keys.

Item Code No.	Tool Bit Size		Holder Size	
	Inch	mm	Inch	mm
ABM-IMT-6700	3/16 to 1/4	4.76 to 6.35	9/16 x 3/4 x 5	14 x 20 x 127
ABM-IMT-6701	1/4 to 5/16	6.35 to 7.93	9/16 x 7/8 x 5-1/2	14 x 22 x 140
ABM-IMT-6702	5/16 to 3/8	7.93 to 9.52	5/8 x 1 x 6	16 x 25 x 150
ABM-IMT-6703	3/8 to 1/2	9.52 to 12.7	3/4 x 1-3/16 x 8	19 x 30 x 200

Tool Holders & Boring Bars

Tool Holders & Boring Bars



Universal Tool Holder

3 Way Tool Holder



- Manufactured from high-grade steel, fully hardened.
- Supplied with suitable allen keys & nuts but without tool bit.
- Tool bit can be hold in three different directions.
- Tool Bits also available on extra cost.

Item Code No.	Capacity Square Tool		Holder Size l x w x h
	Inch	mm	
ABM-IMT-7950	1/4"	6	110 x 12 x 16
ABM-IMT-7951	3/8"	9.5	120 x 14 x 18
ABM-IMT-7952	1/2"	12.7	145 x 18 x 20
ABM-IMT-7953	5/8"	16	175 x 20 x 25
ABM-IMT-7954	3/4"	19	250 x 25 x 32

Mini Parting Holder

Clamp Type



- Grounded & Black Oxidized Surface.
- Available with and without HSS Blade.
- Small & popular holder for Model Makers & Watchmakers.
- SPARE HSS BLADE ALSO AVAILABLE 1.5 x 8.25 x 73.

With Blade Item Code No.	Shank Size mm	Suitable Blade mm
ABM-IMT-6055	8	1.5 x 8.25 x 73
ABM-IMT-6056	10	1.5 x 8.25 x 73
ABM-IMT-6057	12	1.5 x 8.25 x 73

Mini Turning Tool Holder

Sets



Item Code No.

ABM-IMT-6699

- Grounded & Black Oxidized Surface.
- Small & popular holder for Model Makers, Watchmakers & Small lathes.
- Set of 3 Pcs of Turning Tool Holders consisting Straight, Left & Right.
- Consists of HSS Square Tool Bits 1/8" (3mm) x 1" (25 mm).
- Shank Size 5/16" (8 mm)
- Packed in Wooden Finished Box.
- SPARE HSS BLADE ALSO AVAILABLE 3 x 3 x 25 (1/8 x 1/8 x 1").

Parting & Groove Holders



- Supplied with Hex Key.
- Available with and without Tin Coated Insert 3 mm.

Item Code No.	Shank Size	
	mm	Inches
ABM-IMT-6039	8	5/16"
ABM-IMT-6040	10	3/8"
ABM-IMT-6041	12	1/2"
ABM-IMT-6042	14	9/16"
ABM-IMT-6043	16	5/8"
ABM-IMT-6044	20	3/4"
ABM-IMT-6045	25	1"

Tool Holders & Boring Bars



Parting Tool Holder (Eclipse Type)

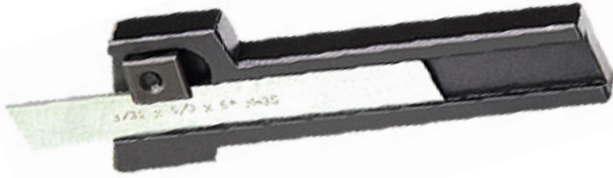

- Accurately Machined, Heat Treated & Hardened.
- Supplied with and without Tool Bits.
- Available in ST (Straight), LT (Left) and RT (Right) Hand Shanks.
- Please specify ST, LT or RT with order.

Item Code No.	Size of Holder	Size of Blade
ABM-IMT-6650	5/16" x 9/16" x 3-1/2" (8 x 14 x 90 mm)	5/16" (8 mm)
ABM-IMT-6651	1/2" x 1-1/8" x 6" (12.7 x 28 x 150 mm)	1/2" x 5/8" (12 x 16 mm)
ABM-IMT-6652	5/8" x 1-3/8" x 7" (16 x 35 x 175 mm)	3/4" x 7/8" (19 x 22 mm)
ABM-IMT-6653	3/4" x 1-1/4" x 7-1/2" (19 x 45 x 188 mm)	1" x 1-1/8" (25 x 28 mm)

J & S Type Cut Off Holder (Cut off Tool Holder) (Parting Off Holder)



- Accurately machined and ground finish in black oxidised.
- Supplied with wrench but without tool bit.
- Series ST (straight), LT (Left) and RT (Right).
- While placing order, please specify for ST, LT or RT holder.
- Heat Treated Hardened Body.
- Support the blade over a wide area, reducing chance of blade breakage.
- Provided with one wrench.

Parting Tool Holder (Cut Off Tool Blocks) (Quick Clamp Parting Tool Holder)

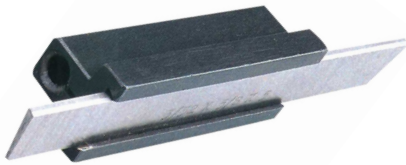

- One Piece construction with 100% Clamping power.
- Can be used both on Front and Rear Tool Post of the Cross Line.
- Holds and guides the Beveled blade in a way that it ensures equal clearance on both sides.
- Supplied with and without HSS / Cobalt Cut Off Blades.
- Blade also available separately.
- Provided with allen Keys.

Item Code No.	Blade Size (wxhxl)	Body Size
		Shank x Width x Length
ABM-IMT-6580	3/32 x 3/8 x 4	2-1/8 x 15/16 x 1
ABM-IMT-6581	3/32 x 1/2 x 4	2-1/8 x 1-3/16 x 1-1/8
ABM-IMT-6582	3/32 x 5/8 x 4	3-1/2 x 1-1/2 x 1-7/16
ABM-IMT-6583	1/8 x 3/4 x 5	3-1/2 x 1-1/2 x 1-1/4

Item Code No.	Holder Size	Blade Size
ABM-IMT-6561	5/16" x 9/16" x 3-1/2" (8 x 14 x 90 mm)	1/16" x 5/16" (1.5 x 8 mm)
ABM-IMT-6562	5/16" x 3/4" x 4-1/2" (8 x 19 x 114 mm)	3/32" x 1/2" (2.4 x 12.7 mm)
ABM-IMT-6563	3/8" x 7/8" x 5" (9.5 x 22 x 125 mm)	3/32" x 5/8" (2.4 x 16 mm)
ABM-IMT-6564	1/2" x 1-1/8" x 6" (12.7 x 28 x 150 mm)	1/8" x 3/4" (3 x 19 mm)
ABM-IMT-6565	5/8" x 1-3/8" x 7" (16 x 35 x 175 mm)	1/8" x 7/8" (3 x 22 mm)
ABM-IMT-6566	3/4" x 1-5/8" x 8" (19 x 41 x 200 mm)	3/16" x 1" (5 x 25 mm)
ABM-IMT-6567	7/8" x 1-3/4" x 9" (22 x 45 x 225 mm)	3/16" x 1-1/8" (5 x 28 mm)
ABM-IMT-6568	1" x 2" x 10" (25 x 50 x 250 mm)	1/4" x 1-1/4" (6.35 x 31.75 mm)

Mini Parting Holder

- Grounded & Black Oxidized Surface.
- Available with and without HSS Blade.
- Small & popular holder for Model Makers & Watchmakers.
- SPARE HSS BLADES ALSO AVAILABLE 1.45 x 5 x 63.

With Blade Item Code No.	Without Blade Item Code No.	Shank Size mm	Suitable Blade mm
ABM-IMT-6046	ABM-IMT-6050	6 x 6 x 80	1.45 x 5 x 63
ABM-IMT-6047	ABM-IMT-6051	8 x 8 x 80	1.45 x 5 x 63
ABM-IMT-6048	ABM-IMT-6052	10 x 10 x 80	1.45 x 5 x 63



Tool Holders & Boring Bars

Parting Tool Holder

- We offer a selection of parting tool holders suitable for Mini lathes, Standard Lathe machine and CNC Turning Centers.
- Made of case Hardened Steel.
- All Parting Tool Holders are uniformly machined and precision ground from the top and bottom.
- Positively locking device ensures rapid and powerful clamping of the cut off blade.
- Cut Off Blades are manufactured from High Speed Steel, Cobalt 5%.
- Hardened and ground all over to ensure maximum cutting efficiency.

Item Code No.	Size of Holder Shank x Width x Length	Size of Cut Off Blades HSS / Cobalt
ABM-IMT-6600	1/4" x 1/4" x 3-3/16"	1/16" x 3/16" x 2-1/2"
ABM-IMT-6601	5/16" x 5/16" x 3-3/16"	1/16" x 7/32" x 2-1/2"
ABM-IMT-6602	3/8" x 3/8" x 3-3/16"	1/16" x 7/32" x 2-1/2"
ABM-IMT-6603	3/8" x 3/8" x 3-1/4"	5/64" x 5/16" x 2-3/4"
ABM-IMT-6604	7/16" x 5/8" x 4"	5/64" x 5/16" x 3-3/16"
ABM-IMT-6605	7/16" x 23/32" x 5"	3/32" x 3/8" x 4"
ABM-IMT-6606	1/2" x 7/8" x 5-3/8"	9/64" x 1/2" x 5"
ABM-IMT-6607	1-1/4" x 2-1/4" x 13"	3/4"

Please specify ST, LT or RT while placing order



Parting Tool Holder for Blades

- Case-hardened and ground
- Positive locking ensures longer blade life
- Firm and positive clamping force by screws on top of mounting plate.

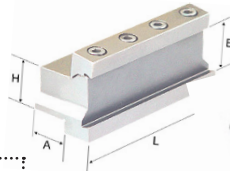

Item Code No.	Size H x A x B x L
ABM-IMT-6620	1/2" x 27/32" x 1" x 3-3/8"
ABM-IMT-6621	3/4" x 27/32" x 1" x 3-3/8"
ABM-IMT-6622	1" x 15/16" x 1-3/16" x 4-3/8"



Parting Tool Holder (Screw Clamping)

- Case-hardened and ground
- Positive locking ensures longer blade life
- Firm and positive clamping force by screws on top of mounting plate.
- Parting Tool Holder uses a blade-like cutting tool plunged directly into the workpiece to cut off the workpiece at a specific length.
- Normally used to remove the finished end of a workpiece from the bar stock that is clamped in the chuck.
- Other uses include things such as cutting the head off a bolt.
- Firm and positive clamping force by screws on top of mounting plate.

Item Code No.	Size of Holder Shank x Width x Length	Size of Cut Off Blade HSS / Cobalt
ABM-IMT-6630	3/8" x 3/4" x 2-3/16"	3/32" x 3/8" x 4"
ABM-IMT-6631	1/2" x 3/4" x 2-3/16"	3/32" x 1/2" x 4"
ABM-IMT-6632	1/2" x 3/4" x 2-3/16"	3/32" x 5/8" x 4"
ABM-IMT-6633	1/2" x 1" x 2-3/16"	1/8" x 3/4" x 6"



Tool Holders & Boring Bars



Parting Tool Holder

Komet Type

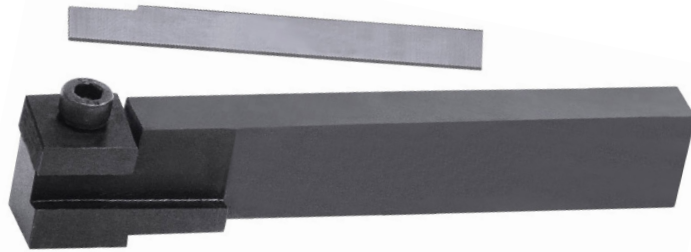

- Precision Ground with Black oxidized Surface.
- Suitable for Komet Lathes.

Item Code No. Holder Only	Item Code No. Holder with Blade	Item Code No. Spare Blade	Shank Size mm	Suitable Blade mm
ABM-IMT-7960	ABM-IMT-7970	ABM-IMT-7980	10 x 10 x 80	2 x 8 x 70
ABM-IMT-7961	ABM-IMT-7971	ABM-IMT-7981	11 x 16 x 100	2 x 8 x 80
ABM-IMT-7962	ABM-IMT-7972	ABM-IMT-7982	11 x 18 x 125	2.5 x 10 x 100
ABM-IMT-7963	ABM-IMT-7973	ABM-IMT-7983	13 x 22 x 135	3.5 x 12 x 125

Saw Holder

Saw Holder Circular

Slitting Saw Holder Straight Shank



Item Code No.

ABM-IMT-6460

- Offer flexibility in sawing operations.
- Spring load mechanism accepts Saw Blades with hole diameter 1/2" to 1".
- Blades are firmly secured in position with Hex screw.
- 1/2" Hardened Shank, 2-1/2" Overall Length.
- Holds all saws with 1/2", 3/4", 7/8" and 1" holes.

Circular Saw Holder Set



- Made from fine quality tool steel.
- For saw blades from .001 to 3/16".
- Shanks are hardened and grounded.
- Supplied in fine finished polished wooden stand & with 2 suitable hex keys.

Item Code No.	Head Dia.	Shank Size	Suitable for Saw Blade Hole Diameter
ABM-IMT-8250	1/2"	1/2"	1/4"
ABM-IMT-8251	5/8"	1/2"	3/8"
ABM-IMT-8252	3/4"	1/2"	1/2"
ABM-IMT-8253	1"	5/8"	5/8"
ABM-IMT-8254	3 Pc Set of ABM-IMT-8250, ABM-IMT-8251 & ABM-IMT-8252		
ABM-IMT-8255	4 Pc Set of ABM-IMT-8250, ABM-IMT-8251, ABM-IMT-8252 & ABM-IMT-8253		

R-8 Saw Holder



- The ring loaded mechanism readily accepts saw blades with hole diameter from 1/2" to 1".
- The blades are firmly secured in position with a hex head screw.
- Offer flexibility in sawing operations.
- Spring load mechanism accepts Saw Blades with hole diameter 1/2" to 1".
- Blades are firmly secured in position with Hex screw.
- Drawbar Thread 7/16 UNF.

Item Code No.

ABM-IMT-6465

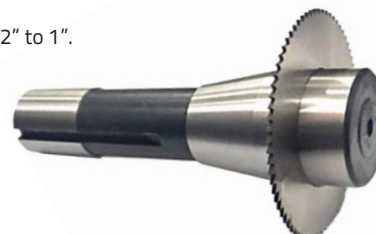

Stub Milling Arbor

For Gear Cutting



- Available in MT2/MT3/MT4.
- Three Versatile Design.
- Gives Rigidity & Stability needed in Milling Operations.
- Each stub milling arbor has its own significance.

Item Code No.	Shank	Suitable Bore	Drawbar Thread
ABM-IMT-8230	MT2	16 mm	M10
ABM-IMT-8231	MT2	22 mm	M10
ABM-IMT-8232	MT2	27 mm	M10
ABM-IMT-8233	MT2	32 mm	M10
ABM-IMT-8234	MT3	16 mm	M12
ABM-IMT-8235	MT3	22 mm	M12
ABM-IMT-8236	MT3	27 mm	M12
ABM-IMT-8237	MT3	32 mm	M12
ABM-IMT-8238	MT4	16 mm	M16
ABM-IMT-8239	MT4	22 mm	M16
ABM-IMT-8240	MT4	27 mm	M16
ABM-IMT-8241	MT4	32 mm	M16

Saw Holder

Taper Shank & MT Shank



- Offer flexibility in sawing operations.
- Accepts Saw Blades From 1/2" till 1" (12 / 16 / 22 / 27 mm).
- Blades are Firmly secured in position with hex head counter screw.
- Supplied in a combination of grinded & black epoxy finish.

Item Code No.	Shank	Drawbar Thread
ABM-IMT-8210	MT2	M10
ABM-IMT-8211	MT3	M12
ABM-IMT-8212	MT2	3/8"
ABM-IMT-8213	MT3	1/2"

Saw & Gear Cutter Holder



- Offer flexibility.
- Blades & Gear Cutting are Firmly secured in position with hex head counter screw.
- Supplied in a combination of grinded & black epoxy finish.

Item Code No.	Shank	Suitable Bore	Drawbar Thread
ABM-IMT-8215	MT2	16 mm	M10
ABM-IMT-8216	MT2	22 mm	M10
ABM-IMT-8217	MT3	16 mm	M12
ABM-IMT-8218	MT3	22 mm	M12

Saw Holder

Mini



- Offer flexibility in sawing operations.
- Supplied in grinded plus black epoxy finish.

Item Code No.	Shank Dia.	Suitable Bore
ABM-IMT-8200	10 mm	16 mm
ABM-IMT-8201	12 mm	22 mm
ABM-IMT-8202	Saw Holder 10 mm + 3 Pc Slitting Saw (45 mm)	

Tool Holders & Boring Bars



Knurling Tool Holder

Single Ended



SINGLE KNURL TOOL

- Knurls are Hob Cut from High Speed Steel and Heat Treated.
- Machined ground steel in Shiny Black Finish.
- Replacement knurls are offered as a complete spare set for knurling Tools.
- Available with Tool Steel Knurls & HSS Knurls.

Item Code No.		ABM-IMT-6529	ABM-IMT-6530
Holder Size	Inch	1/2 x 1/2 x 4-1/2	3/4 x 3/4 x 5
	mm	12.7 x 12.7 x 115	19 x 19 x 125
Size of Knurls	Inch	3/4 x 1/4 x 1/4	3/4 x 3/8 x 1/4
	mm	19 x 6.35 x 6.35	19 x 9.5 x 6.35

Knurling Tool Holder

Double Ended



- Double ended knurling Tool Holder HSS knurls Straight, Fine and Medium.
- Available with Tool Steel Knurls & HSS Knurls.
- Machined ground steel in Shiny Black Finish.

Item Code No.		ABM-IMT-6560
Holder Size	Inch	1/2 x 1/2 x 5
	mm	12.7 x 12.7 x 125
Size of Knurls	Inch	3/4 x 1/4 x 1/4
	mm	19 x 6.35 x 6.35
Knurl Pattern		Fine & Medium

Knurling Tool Holders

American Pattern - Two Wheels



SELF ADJUSTING HEAD KNURLING TOOL

- Double ended knurling Tool Holder HSS knurls Straight, Fine and Medium.
- Comes in pairs.
- Available with Tool Steel Knurls & HSS Knurls.
- Machined ground steel in Shiny Black Finish.

While Placing order please mention Tool Steel Knurls or HSS Knurls

Item Code No.	Holder Size	Size of Knurls
ABM-IMT-6541	5/16" x 3/4" x 5" (18 x 19 x 125 mm)	5/8" x 5/16" x 7/32" (16 x 8 x 5.5 mm)
ABM-IMT-6542	3/8" x 7/8" x 5-1/2" (9.5 x 22 x 138 mm)	5/8" x 5/16" x 7/32" (16 x 8 x 5.5 mm)
ABM-IMT-6543	1/4" x 1-1/8" x 6-1/2" (12.7 x 28 x 163 mm)	3/4" x 3/8" x 1/4" (19 x 9.5 x 6.35 mm)
ABM-IMT-6544	5/8" x 1-3/8" x 7-1/2" (16 x 35 x 188 mm)	3/4" x 3/8" x 1/4" (19 x 9.5 x 6.35 mm)

Knurling Tool Holders

Pivot Head (Two Knurl Wheels)



PIVOT HEAD TYPE KNURLING TOOL

- Knurls are Hob Cut from High Speed Steel and Heat Treated.
- Two knurls Tool is generally provided with medium knurls but other knurls can also be provided if required.
- Machined ground steel in Shiny Black Finish.
- Replacement knurls are offered as a complete spare set for knurling Tools.
- Available with Tool Steel Knurls & HSS Knurls.

Item Code No.	Holder Size	Size of Knurls
ABM-IMT-6531	1/2" x 1/2" x 4-1/2" (12.7 x 12.7 x 115 mm)	3/4" x 3/8" x 1/4" (19 x 9.5 x 6.35 mm)
ABM-IMT-6532	1/2" x 1/2" x 4-1/2" (12.7 x 12.7 x 115 mm)	3/4" x 1/4" x 1/4" (19 x 6.35 x 6.35 mm)
ABM-IMT-6533	5/8" x 5/8" x 4-1/2" (16 x 16 x 115 mm)	3/4" x 3/8" x 1/4" (19 x 9.5 x 6.35 mm)
ABM-IMT-6534	3/4" x 3/4" x 5" (19 x 19 x 125 mm)	1" x 3/8" x 1/4" (25 x 9.5 x 6.35 mm)

Knurling Tool Holder

Revolving Head 3 Knurl



- With the revolving head it prevents the wastage of time in changing knurls every time when required.
- Three knurls are mounted on a single tool which gives high productivity.
- Provides ease of use to operator with its revolving head.

Item Code No.	Holder Size	Size of Knurls
ABM-IMT-8005	1/2" x 1" x 6" (12.7 x 25 x 150 mm)	3/4" x 3/8" x 1/4" (19 x 9.52 x 6.35 mm)

Knurling Tool Holder

Six Knurls / Six Wheels



- Knurls are Hob Cut from High Speed Steel and Heat Treated.
- Six knurls tools is provided with one pair each of fine, medium and coarse knurls.
- Machined ground steel in Shiny Black Finish.
- Replacement knurls are offered as a complete spare set for knurling Tools.
- No of Pairs 3.
- Available with Tool Steel Knurls & HSS Knurls.

Item Code No.	Holder Size	Size of Knurls
ABM-IMT-6535	5/16" x 3/4" x 5" (8 x 19 x 125 mm)	5/8" x 5/16" x 7/32" (16 x 8 x 5.5 mm)
ABM-IMT-6536	3/8" x 7/8" x 5-1/2" (9.5 x 22 x 138 mm)	5/8" x 5/16" x 7/32" (16 x 8 x 5.5 mm)
ABM-IMT-6537	1/2" x 1-1/8" x 6-1/2" (12.7 x 28 x 163 mm)	3/4" x 3/8" x 1/4" (19 x 9.5 x 6.35 mm)
ABM-IMT-6538	5/8" x 1-3/8" x 7-1/2" (16 x 35 x 188 mm)	3/4" x 3/8" x 1/4" (19 x 9.5 x 6.35 mm)

Knurling Tool Holders

Multi Head



MULTI HEAD ATTACHMENT KNURLING TOOL

- Knurling Tool Holder comes with Straight, Fine and Medium Knurl Pair.
- Comes in pairs.
- Available with Tool Steel Knurls & HSS Knurls.
- Machined ground steel in Shiny Black Finish.
- Multi head Knurling Tool holder provides flexibility of using 3 Knurling heads with a single shank.
- 2 Single Knurl Head comes with fitted knurls with medium pattern Straight Line.
- Pivot head knurl head comes fitted with 2 Knurls with Left & Right medium pattern.
- Heads are interchangeable and firmly held with screw in the shank.
- Weldon Shank at the heads provides no slip grip into the shanks.
- While Placing order please mention Tool Steel Knurls or HSS Knurls

Item Code No.	Holder Size	Size of Knurls
ABM-IMT-6553	3/4" x 3/4" x 4" (19 x 19 x 100 mm)	3/4" x 3/8" x 1/4" (19 x 9.52 x 6.35 mm)
		3/4" x 3/8" x 1/4" (19 x 9.52 x 6.35 mm)

Hand Knurling Holder



- This tool puts vertical line knurls into the steel. Set Straight Medium Pitch Knurls.
- The knurls it does make are very crisp and clear.
- Available with Tool Steel Knurls & HSS Knurls.
- Machined ground steel in Shiny Black Finish.

Item Code No.	Holder Size	Size of knurls	Working Capacity
ABM-IMT-6490	9/16 x 2-3/4 x 8" (14 x 69 x 200 mm)	1/2 x 1/4 x 3/16" (12.7 x 6.35 x 4.95)	1/8 - 1" (3-25 mm)

Tool Holders & Boring Bars



Knurling Tool Holder

3 Interchangeable Heads

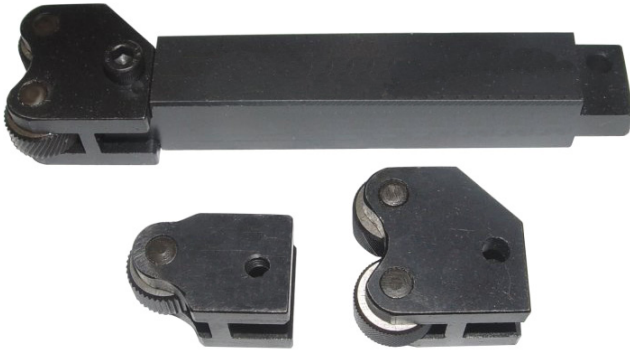

- Have 3 Interchangeable Heads for Center Height Up to 12 & 16mm.
- Usually comes with alloy steel knurls.
- Can also be supplied with high speed steel knurls.
- Manufactured from fine quality steel & finely black oxidized.
- Ideal tool for numerous knurling applications.

Item Code No.	Holder Size	Size of Knurls
ABM-IMT-8000	5/8" x 5/8" x 4-7/8" (16 x 16 x 120 mm)	5/8" x 5/16" x 1/4" (16 x 8 x 6 mm)

Knurling Tool Holder

Linear



- Knurling Tool Holders are manufactured from fine quality steel & finely blackoxidized.
- Knurling Tool Holders are ideal tool for numerous knurling applications.
- This knurling tool is made of high quality 45 # carbon steel, and the wheels are made of CR15, durable in use
- Designed for mini lathe tools, this product is designed for use on mini lathes.
- The quality and gorgeous appearance make you feel stress-free and very convenient, giving you the perfect product experience.
- Great design helps reducing the load on the lathe spindle bearings compared to any other standard knurling tool.
- Apply pressure by rotating the screw instead of the lathe cross slide, which allows you to easily complete the rotating screw with less effort, giving you great convenience.
- It also works for any quick change tool post, a variety of features for you to use.
- Working Capacity is 5 - 33 mm.

Item Code No.	Holder Size	Size of Knurls
ABM-IMT-7990	3/8" x 3/8" x 4" (10 x 10 x 100 mm)	3/4" x 3/8" x 1/4" (14 x 9.52 x 6.35 mm)

Knurling Tool Holder

V Clamp Type

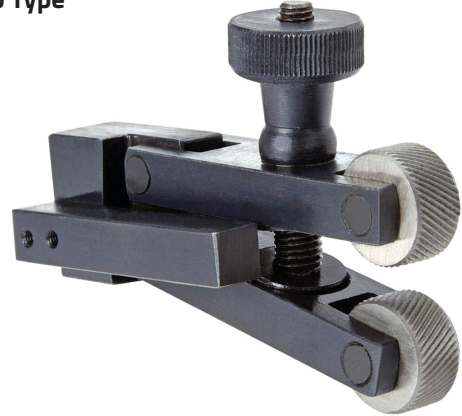

V CLAMP TYPE KNURLING TOOL FOR QUICK CHANGE TOOL POST

- Tool Steel / HSS Knurl Pair LH and RH Medium.
- Knurling pressure is absorbed by Tool Holder.
- Sturdy V Clamp type knurling clamp.
- Can be clamped in Standard Holder of the Quick change tool post on the lathe.
- Working Capacity 3/16" - 3/4" (5 - 20 mm).

Item Code No.	Total Length	Shank Size	Size of Knurls
ABM-IMT-6524	3-3/16" (80 mm)	3/8" x 3/8" x 2-1/4" (9.5 x 9.5 x 56 mm)	3/4" x 3/8" x 1/4" (19 x 9.5 x 6.35 mm)

Knurling Tool Holders

High Capacity - Special



Item Code No.
ABM-IMT-6526

- Designed to have least strain on the light duty lathe's spindle while knurling.
- Pressure adjustment on both arms using fine feed lever.
- Floating Jaws will follow the Work piece and enable knurling to be started in its middle.
- Perfect to make knurls on material like aluminium, Brass where utmost care if required not to tear the material.
- Knurling Capacity Ranges from 0- 4 Inches. (0- 100 mm)
- Both Straight as well as Diamond knurls are available.

Knurling Tool Holder Adjustable Clamp Type

CLAMP TYPE KNURLING TOOL WITH KNOB

- Suitable for Mini Lathe Machine, Small lathe Machine and Medium size lathes.
- Adjustable Spring loaded clamp type knurling type.
- With medium diamond pattern knurls.
- Tool Steel / HSS Knurl LH and RH Medium.
- Pressure is applied by turning screw instead of the lathe cross slide.
- Helps reducing the load on the lathe spindle bearings compared to any other standard knurling tool.
- Self adjusting head automatically adjust to center height.

Item Code No.	Holder Size	Size of Knurls	Working Capacity
ABM-IMT-6522	5/8" x 3/8" x 3" (16 x 9.5 x 75 mm)	3/4" x 3/8" x 1/4" (19 x 9.5 x 6.35 mm)	1/8" - 1" (3 - 25 mm)
ABM-IMT-6523	3/8" x 3/8" x 5-3/4" (9.5 x 9.5 x 145 mm)	3/4" x 3/8" x 1/4" (19 x 9.5 x 6.35 mm)	1/8" - 1" (3 - 25 mm)

While Placing order please mention Tool Steel Knurls or HSS Knurls



Knurling Tool Holder Adjustable Clamp Type Spring Loaded

SPRING LOADED CLAMP TYPE KNURLING TOOL

- Suitable for Mini Lathe Machine.
- Adjustable Spring loaded clamp type knurling type.
- Flexible and adjustable Knurling Tool Holder System.
- Tool Steel / HSS Knurl LH and RH Medium.
- Knurling pressure absorbed by Tool Holder

Item Code No.	Holder Size	Size of Knurls	Working Capacity
ABM-IMT-6520	3/8" x 3/8" x 5-3/4" (9.5 x 9.5 x 147 mm)	3/4" x 3/8" x 1/4" (19 x 9.5 x 6.35 mm)	1/8" - 1" (3 - 25 mm)
ABM-IMT-6521	3/8" x 5/8" x 5-3/8" (9.5 x 16 x 135 mm)	3/4" x 3/8" x 1/4" (19 x 9.5 x 6.35 mm)	1/8" - 1" (3 - 25 mm)

While Placing order please mention Tool Steel Knurls or HSS Knurls

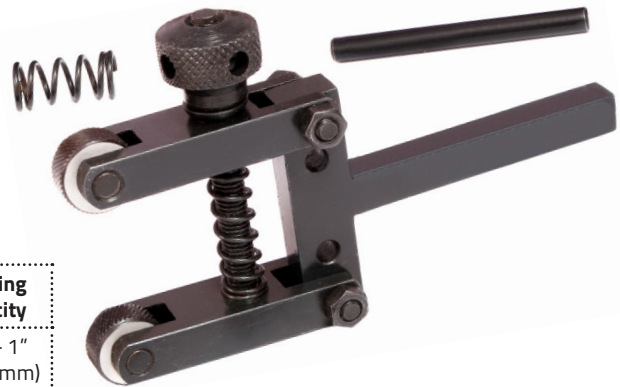

Knurling Tool Holder Adjustable Clamp Type

SPRING LOADED CLAMP TYPE KNURLING TOOL

- Flexible and adjustable Holder System.
- Knurling Tool Holder suitable for CNC Turning Center Tool Steel / HSS Knurl LH and RH Medium.
- Knurling pressure absorbed by Tool Holder

Item Code No.	Holder Size	Size of Knurls	Working Capacity
ABM-IMT-6555	1" x 3/4" x 8-3/4" (25 x 19 x 219 mm)	3/4" x 3/8" x 1/4" (19 x 9.5 x 6.35 mm)	3/16" - 2" (5 - 50 mm)
ABM-IMT-6556	1-3/16" x 1-5/32" x 12-1/4" (30 x 29 x 307 mm)	3/4" x 3/8" x 1/4" (19 x 9.5 x 6.35 mm)	1-3/16" - 4" (30 - 100 mm)
ABM-IMT-6557	3/4" x 3/4" x 6-9/16" (19 x 19 x 165 mm)	3/4" x 3/8" x 1/4" (19 x 9.5 x 6.35 mm)	3/16" - 2" (5 - 50 mm)

While Placing order please mention Tool Steel Knurls or HSS Knurls

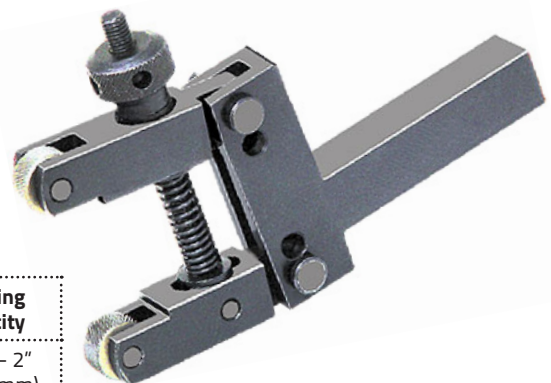

Knurling Tool - Quick Acting

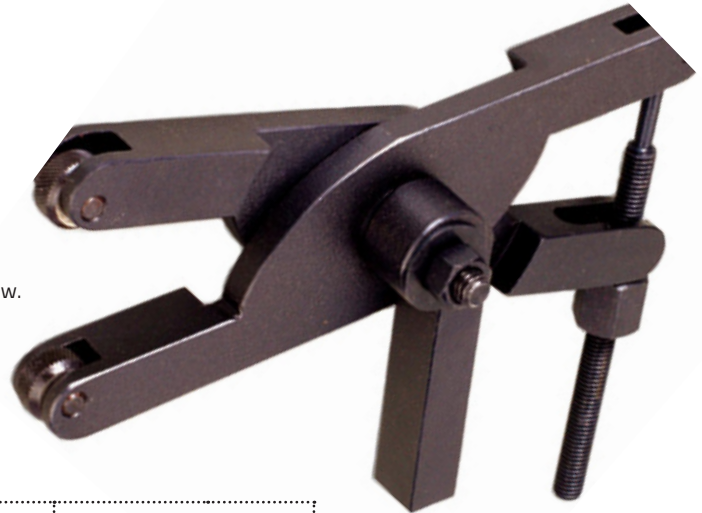

- Fast setup knurling tool.
- Minimizes pressure on lathes compound, centre or crossfeed screw.
- Depth of knurling impression can be preset for production work.
- Furnished with one set of medium diamond pattern knurls 3/4" x 3/8" x 1/4" (19 x 9.5 x 6.35).

Item Code No.	Length		Straight Shank (h x w)		Capacity	
	Inch	mm	Inch	mm	Inch	mm
ABM-IMT-6550	6	150	1/2 x 5/8	12.7 x 15.87	1/16 - 2-1/4	1.6 - 57
ABM-IMT-6551	8-1/4	210	5/8 x 3/4	15.87 x 19.05	2-1/2 - 4-1/2	63 - 112

Spare Knurls



- Available in Tool Steel Knurls & HSS Knurls.
- Knurls are individually cut to obtain sharp, perfectly formed teeth.
- Heat Treated, Tempered and Tested.
- Knurls are finished in pairs to fit all standard makes of knurling Tools.
- Knurls available with us in many shapes like Extra Fine, Medium, Coarse, Left, Right, Straight and Checkered.
- Diamond pattern knurls are provided as a set of right hand and Left Hand knurl.
- Machined ground steel in Shiny Black Finish.

Diamond Pattern Item Code No.	Straight Pattern Item Code No.	Knurling Dimension			Pitch
		Dia.	Width	Holes	
ABM-IMT-6500	ABM-IMT-6509	5/8"	5/16"	7/32"	14
ABM-IMT-6501	ABM-IMT-6510	5/8"	5/16"	7/32"	21
ABM-IMT-6502	ABM-IMT-6511	5/8"	5/16"	7/32"	33
ABM-IMT-6503	ABM-IMT-6512	3/4"	3/8"	1/4"	14
ABM-IMT-6504	ABM-IMT-6513	3/4"	3/8"	1/4"	21
ABM-IMT-6505	ABM-IMT-6514	3/4"	3/8"	1/4"	33
ABM-IMT-6506	ABM-IMT-6515	1"	3/8"	5/16"	14
ABM-IMT-6507	ABM-IMT-6516	1"	3/8"	5/16"	21
ABM-IMT-6508	ABM-IMT-6517	1"	3/8"	5/16"	33

Shank Types

- MAS 403.

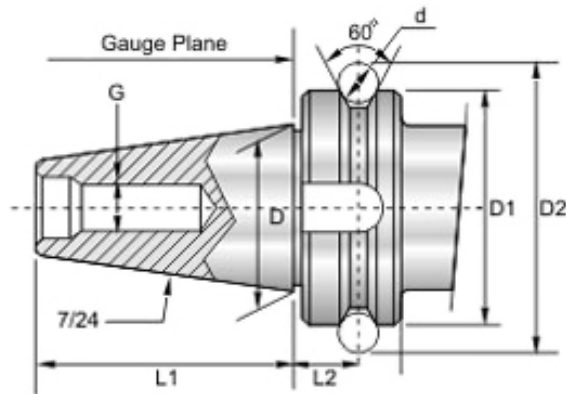

Dimension in mm

Item Code No.	Type	D	D1h8	D2±0.005	G 6H	Measuring Pin d	L1 ± 0.2	L2 ± 0.1
ABM-IMT-6746	BT 30	Ø31.75	Ø46	54.144	M12	Ø8	48.4	13.6
ABM-IMT-6747	BT 40	Ø44.45	Ø63	75.679	M16	Ø10	65.4	16.6
ABM-IMT-6748	BT 45	Ø57.15	Ø85	100.216	M20	Ø12	82.8	21.2
ABM-IMT-6749	BT 50	Ø69.85	Ø100	119.020	M24	Ø15	101.8	23.2

- DIN 69871 / ISO 7388.
- DIN 69871 - Form B for coolant holes through flange.
- DIN 69871 - Form A without coolant holes through flange.
- TC is also called as SK.
- TC type can be used in place of CAT and ANSI.

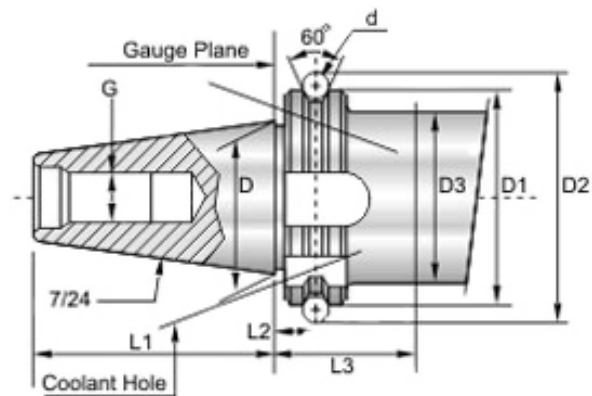

Dimension in mm

Item Code No.	Type	D	D1 0.1	D2±0.005	D3 Max	G 6H	Measuring Pin d	L1 ± 0.3	L2 ± 0.1	L3 min
ABM-IMT-6770	TC 30	Ø31.75	Ø50.00	59.30	M12	M12	--	47.8	--	--
ABM-IMT-6771	TC 40	Ø44.45	Ø63.55	72.30	M16	M16	Ø7	68.4	11.1	35
ABM-IMT-6772	TC 45	Ø57.15	Ø82.55	91.35	M20	M20	--	82.7	--	--
ABM-IMT-6773	TC 50	Ø69.85	Ø97.50	107.25	M24	M24	--	101.75	--	--

Item Code No.
ABM-IMT-6780

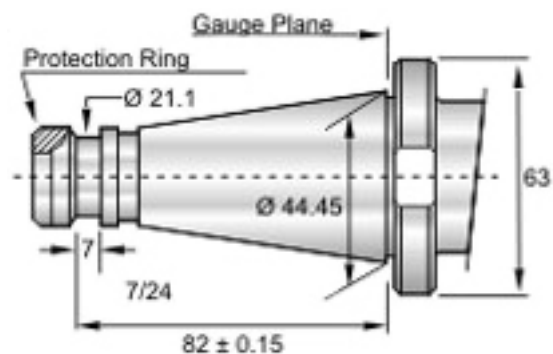

- DIN 2080 / ISO 40.
- Universal type Suitable for Conventional & CNC milling machines with DRAW BAR.
- CNC milling machines like deckel mikron, maho fitted with hydraulic clamping arrangement.

Collet Holders BT MAS 403 / ER

- Form A & AD is without Coolent holes through flanges.
- Form B is with Coolent holes through flanges.

Dimension in mm

Form A & AD Item Code No.	Form B Item Code No.	Type	D	D1	L	L1	L2	G	G1
ABM-IMT-6800	--	BT 30 / ER 16 x 080	28	28	80	69.5	51.5	M 12	M 12
ABM-IMT-6801	-	BT 30 / ER 16 x 100	28	28	100	89.5	71.5	M 12	M 12
ABM-IMT-6802	-	BT 30 / ER 25 x 060	42	46	60	48.5	28.4	M 12	M 12
ABM-IMT-6803	-	BT 30 / ER 25 x 100	42	46	100	88.4	68.4	M 12	M 12
ABM-IMT-6804	-	BT 30 / ER 32 x 060	50	40	60	47.3	--	M 12	M 12
ABM-IMT-6805	-	BT 30 / ER 32 x 100	50	46	100	87.3	62.0	M 12	M 12
ABM-IMT-6806	ABM-IMT-6835	BT 40 / ER 16 x 070	28	28	70	59.5	41.5	M 16	M 12
ABM-IMT-6807	ABM-IMT-6836	BT 40 / ER 16 x 100	28	28	100	89.5	71.5	M 16	M 12
ABM-IMT-6808	ABM-IMT-6837	BT 40 / ER 16 x 150	28	28	150	139.5	121.5	M 16	M 12
ABM-IMT-6809	ABM-IMT-6838	BT 40 / ER 25 x 70	42	42	70	58.0	38.0	M 16	M 12
ABM-IMT-6810	ABM-IMT-6839	BT 40 / ER 25 x 100	42	42	100	88.0	68.0	M 16	M 12
ABM-IMT-6811	ABM-IMT-6840	BT 40 / ER 25 x 150	42	42	150	138.0	118.0	M 16	M 12
ABM-IMT-6812	ABM-IMT-6841	BT 40 / ER 32 x 150	50	63	70	57.0	35.0	M 16	M 12
ABM-IMT-6813	ABM-IMT-6842	BT 40 / ER 32 x 150	50	50	100	87.0	65.0	M 16	M 12
ABM-IMT-6814	ABM-IMT-6843	BT 40 / ER 32 x 150	50	50	150	137.0	115.0	M 16	M 12
ABM-IMT-6815	ABM-IMT-6844	BT 40 / ER 40 x 150	63	63	80	65.5	43.5	M 16	M 12
ABM-IMT-6816	ABM-IMT-6845	BT 40 / ER 40 x 150	63	63	100	85.5	63.5	M 16	M 12
ABM-IMT-6817	ABM-IMT-6846	BT 40 / ER 40 x 150	63	50	150	135.5	--	M 16	M 12
ABM-IMT-6818	ABM-IMT-6847	BT 50 / ER 16 x 100	28	28	100	89.5	71.5	M 24	M 12
ABM-IMT-6819	ABM-IMT-6848	BT 50 / ER 16 x 150	28	28	150	139.5	121.5	M 24	M 12
ABM-IMT-6820	ABM-IMT-6849	BT 50 / ER 32 x 100	50	50	100	87.5	65.5	M 24	M 12
ABM-IMT-6821	ABM-IMT-6850	BT 50 / ER 32 x 160	50	50	160	147.5	125.5	M 24	M 12
ABM-IMT-6822	ABM-IMT-6851	BT 50 / ER 40 x 100	63	63	100	85.5	63.5	M 24	M 12
ABM-IMT-6823	ABM-IMT-6852	BT 50 / ER 40 x 160	63	50	160	147.5	--	M 24	M 12
ABM-IMT-6824	ABM-IMT-6853	BT 50 / ER 50 x 100	78	64	100	79.5	--	M 24	M 12

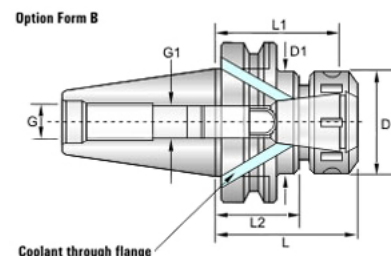
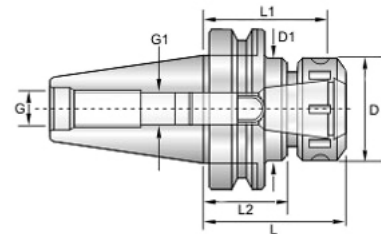

Morse Taper Adaptor BT MAS 403 / MTA

Dimension in mm

Item Code No.	Type	D	D1	L	G
ABM-IMT-6870	BT 30 / MTA1 x 045	MT1	25	45	M12
ABM-IMT-6871	BT 30 / MTA1 x 100	MT1	25	100	M 12
ABM-IMT-6872	BT 30 / MTA2 x 060	MT2	32	60	M 12
ABM-IMT-6873	BT 30 / MTA2 x 120	MT2	32	120	M 12
ABM-IMT-6874	BT 30 / MTA3 x 075	MT3	40	75	M 12
ABM-IMT-6875	BT 30 / MTA3 x 135	MT3	40	135	M 12
ABM-IMT-6876	BT 40 / MTA1 x 045	MT1	25	45	M 16
ABM-IMT-6877	BT 40 / MTA1 x 120	MT1	25	120	M 16
ABM-IMT-6878	BT 40 / MTA2 x 060	MT2	32	60	M 16
ABM-IMT-6879	BT 40 / MTA2 x 120	MT2	32	120	M 16
ABM-IMT-6880	BT 40 / MTA3 x 075	MT3	40	75	M 16
ABM-IMT-6881	BT 40 / MTA3 x 135	MT3	40	135	M 16
ABM-IMT-6882	BT 40 / MTA4 x 095	MT4	48	95	M 16
ABM-IMT-6883	BT 40 / MTA4 x 165	MT4	48	165	M 16
ABM-IMT-6884	BT 50 / MTA1 x 045	MT1	25	45	M 24
ABM-IMT-6885	BT 50 / MTA1 x 120	MT1	25	120	M 24
ABM-IMT-6886	BT 50 / MTA1 x 180	MT1	25	180	M 24
ABM-IMT-6887	BT 50 / MTA2 x 045	MT2	32	45	M 24
ABM-IMT-6888	BT 50 / MTA2 x 120	MT2	32	120	M 24
ABM-IMT-6889	BT 50 / MTA2 x 180	MT2	32	180	M 24
ABM-IMT-6890	BT 50 / MTA3 x 065	MT3	40	65	M 24
ABM-IMT-6891	BT 50 / MTA3 x 135	MT3	40	135	M 24
ABM-IMT-6892	BT 50 / MTA3 x 180	MT3	40	180	M 24
ABM-IMT-6893	BT 50 / MTA4 x 075	MT4	48	75	M 24
ABM-IMT-6894	BT 50 / MTA4 x 180	MT4	48	180	M 24
ABM-IMT-6895	BT 50 / MTA5 x 105	MT5	63	105	M 24

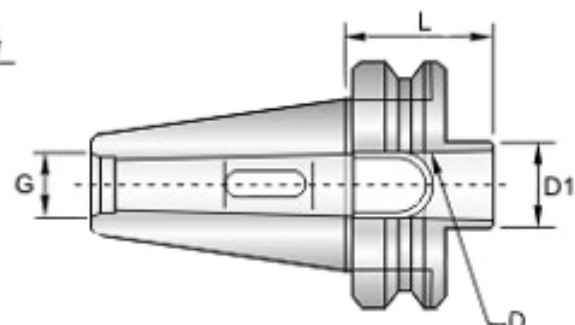
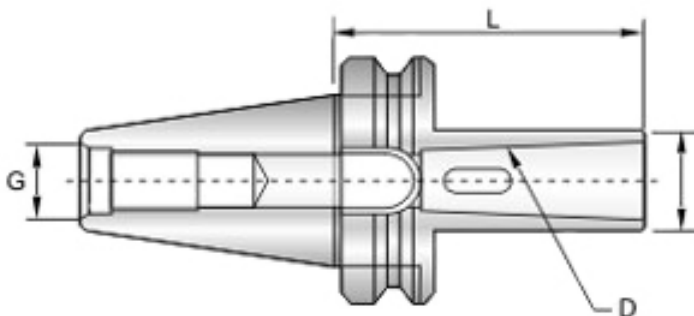

End Mill Holder (Weldon) BT MAS 403 / SL-SLA

Dimension in mm

Item Code No.	Type	D	D1	L	L1	L2	G	G1
ABM-IMT-6950	BT 30 / SL 6 x 065	6	25	65	17.5	--	M 12	M 6
ABM-IMT-6951	BT 30 / SL 8 x 065	8	28	65	17.5	--	M 12	M 8
ABM-IMT-6952	BT 30 / SL 10 x 065	10	35	65	19.5	--	M 12	M 10
ABM-IMT-6953	BT 30 / SL 12 x 065	12	42	65	22.0	--	M 12	M 12
ABM-IMT-6954	BT 30 / SL 14 x 065	14	44	65	22.0	--	M 12	M 12
ABM-IMT-6955	BT 30 / SL 16 x 065	16	48	65	23.5	--	M 12	M 14
ABM-IMT-6956	BT 30 / SL 18 x 065	18	50	65	23.5	--	M 12	M 14
ABM-IMT-6957	BT 30 / SL 20 x 090	20	52	90	24.5	--	M 12	M 16
ABM-IMT-6958	BT 40 / SLA 25 x 090	25	65	90	23.5	--	M 12	M 18 x 2
ABM-IMT-6959	BT 40 / SL 6 x 065	6	25	65	17.5	--	M 16	M 6
ABM-IMT-6960	BT 40 / SL 8 x 065	8	28	65	17.5	--	M 16	M 8
ABM-IMT-6961	BT 40 / SL 10 x 065	10	35	65	19.5	--	M 16	M 10
ABM-IMT-6962	BT 40 / SL 12 x 065	12	42	65	22.0	--	M 16	M 12
ABM-IMT-6963	BT 40 / SL 14 x 065	14	44	65	22.0	--	M 16	M 12
ABM-IMT-6964	BT 40 / SL 16 x 065	16	48	65	23.5	--	M 16	M 14
ABM-IMT-6965	BT 40 / SL 18 x 065	18	50	65	23.5	--	M 16	M 14
ABM-IMT-6966	BT 40 / SL 20 x 090	20	52	90	24.5	--	M 16	M 16
ABM-IMT-6967	BT 40 / SLA 25 x 090	25	65	90	23.5	25	M 16	M 18 x 2
ABM-IMT-6968	BT 40 / SLA 32 x 090	32	72	90	23.5	28	M 16	M 20 x 2
ABM-IMT-6969	BT 50 / SL 6 x 075	6	25	75	17.5	--	M 24	M 6
ABM-IMT-6970	BT 50 / SL 8 x 075	8	28	75	17.5	--	M 24	M 8
ABM-IMT-6971	BT 50 / SL 10 x 075	10	35	75	19.5	--	--	M 10
ABM-IMT-6972	BT 50 / SL 12 x 075	12	42	75	22.0	--	M 24	M 12
ABM-IMT-6973	BT 50 / SL 14 x 075	14	44	75	22.0	--	M 24	M 12
ABM-IMT-6974	BT 50 / SL 16 x 075	16	48	75	23.5	--	M 24	M 14
ABM-IMT-6975	BT 50 / SL 18 x 075	18	50	75	23.5	--	M 24	M 14
ABM-IMT-6976	BT 50 / SL 20 x 105	20	52	105	24.5	--	M 24	M 16
ABM-IMT-6977	BT 50 / SL 25 x 105	25	65	105	23.5	25	M 24	M 18 x 2
ABM-IMT-6978	BT 50 / SL 32 x 105	32	72	105	23.5	28	M 24	M 20 x 2
ABM-IMT-6979	BT 50 / SL 40 x 105	40	84	105	23.5	34	M 24	M 24 x 2

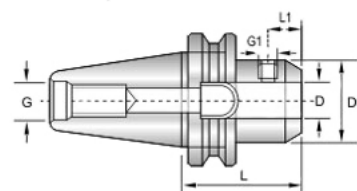
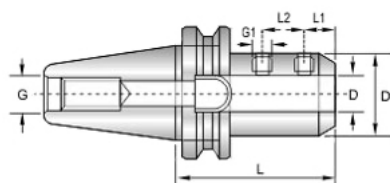

Face Mill Arbor BT MAS 403 / FMB

Dimension in mm

Item Code No.	Type	D	D1	L	L1	G	G1
ABM-IMT-7000	BT 30 / FMB 16 x 045	16	40	45	17	M 12	M 8
ABM-IMT-7001	BT 30 / FMB 22 x 047	22	45	47	19	M 12	M 10
ABM-IMT-7002	BT 30 / FMB 27 x 050	27	63	50	21	M 12	M 12
ABM-IMT-7003	BT 40 / FMB 22 x 055	22	45	55	19	M 16	M 10
ABM-IMT-7004	BT 40 / FMB 27 x 060	27	63	60	21	M 16	M 12
ABM-IMT-7005	BT 40 / FMB 27 x 090	27	63	90	21	M 16	M 12
ABM-IMT-7006	BT 40 / FMB 32 x 060	32	78	60	24	M 16	M 16
ABM-IMT-7007	BT 40 / FMB 32 x 090	32	78	90	24	M 16	M 16
ABM-IMT-7008	BT 40 / FMB 40 x 060	40	90	60	27	M 16	M 20
ABM-IMT-7009	BT 40 / FMB 40 x 075	40	90	75	27	M 16	M 20
ABM-IMT-7010	BT 50 / FMB 27 x 045	27	63	45	21	M 24	M 12
ABM-IMT-7011	BT 50 / FMB 27 x 090	27	63	90	21	M 24	M 12
ABM-IMT-7012	BT 50 / FMB 27 x 150	27	63	150	21	M 24	M 12
ABM-IMT-7013	BT 50 / FMB 32 x 060	32	78	60	24	M 24	M 16
ABM-IMT-7014	BT 50 / FMB 32 x 090	32	78	90	24	M 24	M 16
ABM-IMT-7015	BT 50 / FMB 40 x 060	40	90	60	27	M 24	M 20
ABM-IMT-7016	BT 50 / FMB 40 x 075	40	90	75	27	M 24	M 20
ABM-IMT-7017	BT 50 / FMB 40 x 105	40	90	105	27	M 24	M 20

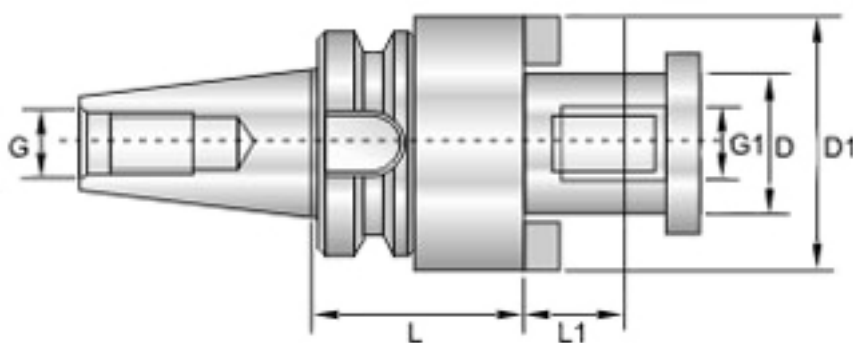

Comb-Shell / Shoulder Mill Arbor BT MAS 403 / FMC

Dimension in mm

Item Code No.	Type	D	D1	L	L1	G	G1
ABM-IMT-7050	BT 30 / FMC 22 x 045	22	40	45	19	M 12	M 10
ABM-IMT-7051	BT 30 / FMC 22 x 045	22	40	45	19	M 16	M 10
ABM-IMT-7052	BT 30 / FMC 22 x 090	22	40	90	19	M 16	M 10
ABM-IMT-7053	BT 40 / FMC 27 x 060	27	48	60	21	M 16	M 12
ABM-IMT-7054	BT 40 / FMC 27 x 090	27	48	90	21	M 16	M 12
ABM-IMT-7055	BT 40 / FMC 32 x 060	32	58	60	24	M 16	M 16
ABM-IMT-7056	BT 40 / FMC 32 x 075	32	58	75	24	M 16	M 16
ABM-IMT-7057	BT 40 / FMC 40 x 060	40	76	60	27	M 16	M 20
ABM-IMT-7058	BT 50 / FMC 22 x 060	22	40	60	19	M 24	M 10
ABM-IMT-7059	BT 50 / FMC 22 x 105	22	40	105	19	M 24	M 10
ABM-IMT-7060	BT 50 / FMC 27 x 045	27	48	45	21	M 24	M 12
ABM-IMT-7061	BT 50 / FMC 27 x 090	27	48	90	21	M 24	M 12
ABM-IMT-7062	BT 50 / FMC 27 x 150	27	48	150	21	M 24	M 12
ABM-IMT-7063	BT 50 / FMC 32 x 045	32	58	45	24	M 24	M 16
ABM-IMT-7064	BT 50 / FMC 32 x 075	32	58	75	24	M 24	M 16
ABM-IMT-7065	BT 50 / FMC 32 x 105	32	58	105	24	M 24	M 16
ABM-IMT-7066	BT 50 / FMC 40 x 060	40	76	60	27	M 24	M 20

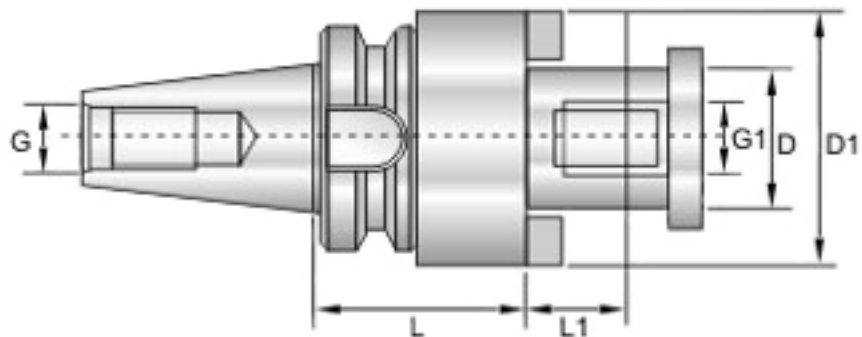

Shell End Mill Arbor BT MAS 403 / SMS

Dimension in mm

Item Code No.	Type	D	D1	L	L1	G	G1
ABM-IMT-7100	BT 30 / SMS 16 x 030	16	32	30	14	M 12	M 8
ABM-IMT-7101	BT 30 / SMS 22 x 030	22	40	30	16	M 12	M 10
ABM-IMT-7102	BT 40 / SMS 16 x 060	16	32	60	14	M 16	M 8
ABM-IMT-7103	BT 40 / SMS 16 x 120	16	32	120	14	M 16	M 8
ABM-IMT-7104	BT 40 / SMS 22 x 060	22	40	60	16	M 16	M 10
ABM-IMT-7105	BT 40 / SMS 22 x 120	22	40	120	16	M 16	M 10
ABM-IMT-7106	BT 40 / SMS 27 x 045	27	48	45	18	M 16	M 12
ABM-IMT-7107	BT 40 / SMS 27 x 105	27	48	105	18	M 16	M 12
ABM-IMT-7108	BT 40 / SMS 32 x 045	32	58	45	20	M 16	M 16
ABM-IMT-7109	BT 40 / SMS 32 x 075	32	58	75	20	M 16	M 16
ABM-IMT-7110	BT 50 / SMS 16 x 075	16	32	75	14	M 24	M 8
ABM-IMT-7111	BT 50 / SMS 16 x 120	16	32	120	14	M 24	M 8
ABM-IMT-7112	BT 50 / SMS 22 x 075	22	40	75	16	M 24	M 10
ABM-IMT-7113	BT 50 / SMS 22 x 120	22	40	120	16	M 24	M 10
ABM-IMT-7114	BT 50 / SMS 27 x 060	27	48	60	18	M 24	M 12
ABM-IMT-7115	BT 50 / SMS 27 x 105	27	48	105	18	M 24	M 12
ABM-IMT-7116	BT 50 / SMS 32 x 045	32	58	45	20	M 24	M 16
ABM-IMT-7117	BT 50 / SMS 32 x 075	32	58	75	20	M 24	M 16
ABM-IMT-7118	BT 50 / SMS 40 x 045	40	70	45	23	M 24	M 20
ABM-IMT-7119	BT 50 / SMS 40 x 075	40	70	75	23	M 24	M 20
ABM-IMT-7120	BT 50 / SMS 50 x 060	50	90	60	26	M 24	M 24

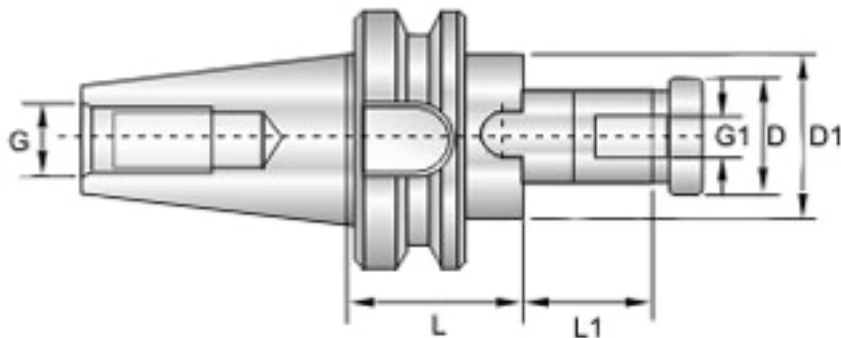

Collet Holders SK-DIN 69871 / ER

- Form A & AD is without Coolent holes through flanges.
- Form B is with Coolent holes through flanges.

Dimension in mm

Form A & AD Item Code No.	Form B Item Code No.	Type	D	D1	L	L1	L2	G	G1
ABM-IMT-7150	ABM-IMT-7200	SK 30 / ER 16 x 070	28	28	70	59.5	41.5	M 12	M 12
ABM-IMT-7151	ABM-IMT-7201	SK 30 / ER 16 x 100	28	28	100	89.5	71.5	M 12	M 12
ABM-IMT-7152	ABM-IMT-7202	SK 30 / ER 25 x 060	42	32	60	48.4	--	M 12	M 12
ABM-IMT-7153	ABM-IMT-7203	SK 30 / ER 25 x 100	42	40	100	52.4	--	M 12	M 12
ABM-IMT-7154	ABM-IMT-7204	SK 30 / ER 32 x 065	50	40	65	52.4	--	M 12	M 12
ABM-IMT-7155	ABM-IMT-7205	SK 30 / ER 32 x 100	50	40	100	87.3	--	M 12	M 12
ABM-IMT-7156	ABM-IMT-7206	SK 40 / ER 16 x 070	28	44.45	70	59.5	33.0	M 16	M 12
ABM-IMT-7157	ABM-IMT-7207	SK 40 / ER 16 x 100	28	44.45	100	89.4	35.0	M 16	M 12
ABM-IMT-7158	ABM-IMT-7208	SK 40 / ER 16 x 150	28	44.45	150	139.4	56.0	M 16	M 12
ABM-IMT-7159	ABM-IMT-7209	SK 40 / ER 25 x 070	42	44.45	70	58.0	38.0	M 16	M 12
ABM-IMT-7160	ABM-IMT-7210	SK 40 / ER 25 x 100	42	44.45	100	88.0	33.50	M 16	M 12
ABM-IMT-7161	ABM-IMT-7211	SK 40 / ER 25 x 150	42	44.45	150	138.0	33.50	M 16	M 12
ABM-IMT-7162	ABM-IMT-7212	SK 40 / ER 32 x 070	50	44.45	70	57.5	35.5	M 16	M 12
ABM-IMT-7163	ABM-IMT-7213	SK 40 / ER 32 x 100	50	44.45	100	87.0	65.5	M 16	M 12
ABM-IMT-7164	ABM-IMT-7214	SK 40 / ER 32 x 150	50	44.45	150	137.5	115.5	M 16	M 12
ABM-IMT-7165	ABM-IMT-7215	SK 40 / ER 40 x 080	63	44.45	80	65.5	35.0	M 16	M 12
ABM-IMT-7166	ABM-IMT-7216	SK 40 / ER 40 x 100	63	44.45	100	85.5	34.5	M 16	M 12
ABM-IMT-7167	ABM-IMT-7217	SK 40 / ER 40 x 150	63	44.45	150	135.5	35.0	M 16	M 12
ABM-IMT-7168	ABM-IMT-7218	SK 50 / ER 16 x 100	28	28	100	89.5	71.5	M 24	M 12
ABM-IMT-7169	ABM-IMT-7219	SK 50 / ER 16 x 150	28	28	150	139.5	121.5	M 24	M 12
ABM-IMT-7170	ABM-IMT-7220	SK 50 / ER 32 x 100	50	69.85	100	87.5	35.0	M 24	M 12
ABM-IMT-7171	ABM-IMT-7221	SK 50 / ER 32 x 160	50	69.85	160	147.5	38.5	M 24	M 12
ABM-IMT-7172	ABM-IMT-7222	SK 50 / ER 40 x 100	63	69.85	100	85.5	39.0	M 24	M 12
ABM-IMT-7173	ABM-IMT-7223	SK 50 / ER 40 x 160	63	69.85	160	145.5	48.5	M 24	M 12
ABM-IMT-7174	ABM-IMT-7224	SK 50 / ER 50 x 100	78	69.85	100	79.3	49.5	M 24	M 12

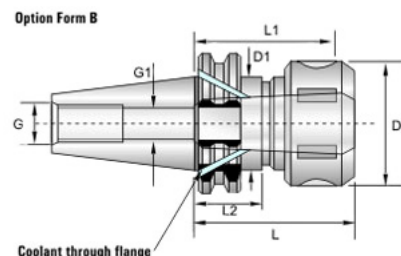
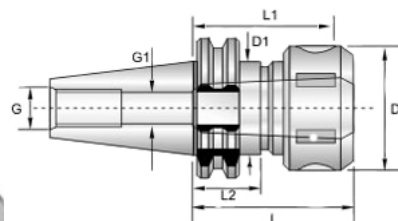

Morse Taper Adaptor SK-DIN 69871 / MTA

Dimension in mm

Item Code No.	Type	D	D1	L	G
ABM-IMT-7240	SK 30 / MTA1 x 045	MT1	25	45	M 12
ABM-IMT-7241	SK 30 / MTA1 x 100	MT1	25	100	M 12
ABM-IMT-7242	SK 30 / MTA2 x 060	MT2	32	60	M 12
ABM-IMT-7243	SK 30 / MTA2 x 120	MT2	32	120	M 12
ABM-IMT-7244	SK 30 / MTA3 x 075	MT3	40	75	M 12
ABM-IMT-7245	SK 30 / MTA3 x 135	MT3	40	135	M 12
ABM-IMT-7246	SK 40 / MTA1 x 045	MT1	25	45	M 16
ABM-IMT-7247	SK 40 / MTA1 x 120	MT1	25	120	M 16
ABM-IMT-7248	SK 40 / MTA2 x 060	MT2	32	60	M 16
ABM-IMT-7249	SK 40 / MTA2 x 120	MT2	32	120	M 16
ABM-IMT-7250	SK 40 / MTA3 x 75	MT3	40	75	M 16
ABM-IMT-7251	SK 40 / MTA3 x 135	MT3	40	135	M 16
ABM-IMT-7252	SK 40 / MTA4 x 095	MT4	48	95	M 16
ABM-IMT-7253	SK 40 / MTA4 x 165	MT4	48	165	M 16
ABM-IMT-7254	SK 50 / MTA1 x 045	MT1	25	45	M 24
ABM-IMT-7255	SK 50 / MTA1 x 120	MT1	25	120	M 24
ABM-IMT-7256	SK 50 / MTA1 x 180	MT1	25	180	M 24
ABM-IMT-7257	SK 50 / MTA2 x 045	MT2	32	45	M 24
ABM-IMT-7258	SK 50 / MTA2 x 120	MT2	32	120	M 24
ABM-IMT-7259	SK 50 / MTA2 x 180	MT2	32	180	M 24
ABM-IMT-7260	SK 50 / MTA3 x 065	MT3	40	65	M 24
ABM-IMT-7261	SK 50 / MTA3 x 135	MT3	40	135	M 24
ABM-IMT-7262	SK 50 / MTA3 x 180	MT3	40	180	M 24
ABM-IMT-7263	SK 50 / MTA4 x 075	MT4	48	75	M 24
ABM-IMT-7264	SK 50 / MTA4 x 180	MT4	48	180	M 24
ABM-IMT-7265	SK 50 / MTA5 x 105	MT5	63	105	M 24

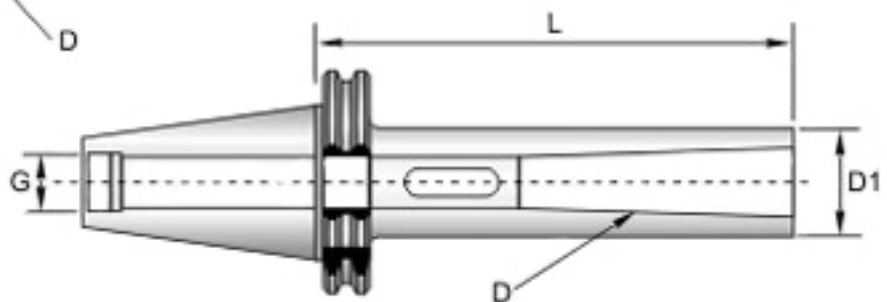
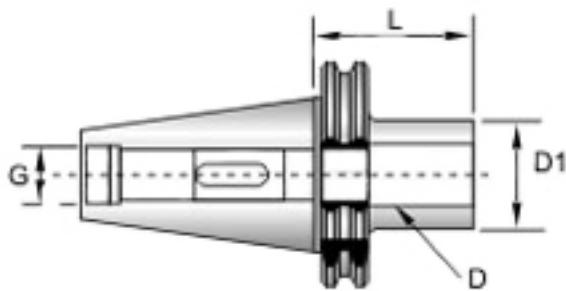

End Mill Holder (Weldon) DIN 69871 AD

Dimension in mm

Item Code No.	Type	D	D1	L	L1	L2	G	G1
ABM-IMT-7280	SK 30 / SL 6 x 065	6	25	65	17.5	--	M 12	M 6
ABM-IMT-7281	SK 30 / SL 8 x 065	8	28	65	17.5	--	M 12	M 8
ABM-IMT-7282	SK 30 / SL 10 x 065	10	35	65	19.5	--	M 12	M 10
ABM-IMT-7283	SK 30 / SL 12 x 065	12	42	65	22.0	--	M 12	M 12
ABM-IMT-7284	SK 30 / SL 14 x 065	14	44	65	22.0	--	M 12	M 12
ABM-IMT-7285	SK 30 / SL 16 x 065	16	48	65	23.5	--	M 12	M 14
ABM-IMT-7286	SK 30 / SL 18 x 065	18	50	65	23.5	--	M 12	M 14
ABM-IMT-7287	SK 30 / SL 20 x 090	20	52	90	24.5	--	M 12	M 16
ABM-IMT-7288	SK 30 / SL 25 x 090	25	65	90	23.5	25	M 12	M 18 X 2
ABM-IMT-7289	SK 40 / SL 6 x 065	6	25	65	17.5	--	M 16	M 6
ABM-IMT-7290	SK 40 / SL 8 x 065	8	28	65	17.5	--	M 16	M 8
ABM-IMT-7291	SK 40 / SL 10 x 065	10	35	65	19.5	--	M 16	M 10
ABM-IMT-7292	SK 40 / SL 12 x 065	12	42	65	22.0	--	M 16	M 12
ABM-IMT-7293	SK 40 / SL 14 x 065	14	44	65	22.0	--	M 16	M 12
ABM-IMT-7294	SK 50 / SL 16 x 065	16	48	65	23.5	--	M 16	M 14
ABM-IMT-7295	SK 50 / SL 18 x 065	18	50	65	23.5	--	M 16	M 14
ABM-IMT-7296	SK 50 / SL 20 x 090	20	52	90	24.5	--	M 16	M 16
ABM-IMT-7297	SK 50 / SLA25 x 090	25	65	90	24.5	25	M 16	M 18 x 2
ABM-IMT-7298	SK 50 / SLA32 x 090	32	72	90	23.5	28	M 16	M 20 x 2
ABM-IMT-7299	SK 50 / SL 6 x 075	6	25	75	17.5	--	M 24	M 6
ABM-IMT-7300	SK 50 / SL 8 x 075	8	28	75	17.5	--	M 24	M 8
ABM-IMT-7301	SK 50 / SL 10 x 075	10	35	75	19.5	--	--	M 10
ABM-IMT-7302	SK 50 / SL 12 x 075	12	42	75	22.0	--	M 24	M 12
ABM-IMT-7303	SK 50 / SL 14 x 075	14	44	75	22.0	--	M 24	M 12
ABM-IMT-7304	SK 50 / SL 16 x 075	16	48	75	23.5	--	M 24	M 14
ABM-IMT-7305	SK 50 / SL 18 x 075	18	50	75	23.5	--	M 24	M 14
ABM-IMT-7306	SK 50 / SL 20 x 105	20	52	105	24.5	--	M 24	M 16
ABM-IMT-7307	SK 50 / SLA 25 x 105	25	65	105	23.5	25	M 24	M 18 x 2
ABM-IMT-7308	SK 50 / SLA 32 x 105	32	72	105	23.5	28	M 24	M 20 x 2
ABM-IMT-7309	SK 50 / SLA 40 x 105	40	84	105	23.5	34	M 24	M 24 x 2

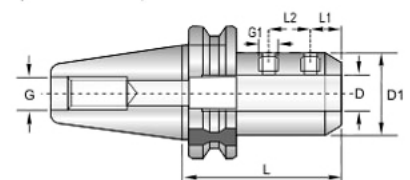
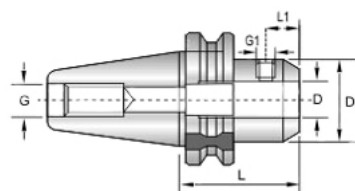

Face Mill Arbor SK-DIN 69871 SK / FMB

Dimension in mm

Item Code No.	Type	D	D1	L	L1	G	G1
ABM-IMT-7350	SK 30 / FMB 16 x 045	16	40	45	17	M 12	M 8
ABM-IMT-7351	SK 30 / FMB 22 x 047	22	45	47	19	M 12	M 10
ABM-IMT-7352	SK 30 / FMB 27 x 050	27	63	50	21	M 12	M 12
ABM-IMT-7353	SK 40 / FMB 22 x 055	22	45	55	19	M 16	M 10
ABM-IMT-7354	SK 40 / FMB 27 x 060	27	63	60	21	M 16	M 12
ABM-IMT-7355	SK 40 / FMB 27 x 090	27	63	90	21	M 16	M 12
ABM-IMT-7356	SK 40 / FMB 32 x 060	32	78	60	24	M 16	M 16
ABM-IMT-7357	SK 40 / FMB 32 x 090	32	78	90	24	M 16	M 16
ABM-IMT-7358	SK 40 / FMB 40 x 060	40	90	60	27	M 16	M 20
ABM-IMT-7359	SK 40 / FMB 40 x 075	40	90	75	27	M 16	M 20
ABM-IMT-7360	SK 50 / FMB 27 x 045	27	63	45	21	M 24	M 12
ABM-IMT-7361	SK 50 / FMB 27 x 090	27	63	90	21	M 24	M 12
ABM-IMT-7362	SK 50 / FMB 27 x 150	27	63	150	21	M 24	M 12
ABM-IMT-7363	SK 50 / FMB 32 x 060	32	78	60	24	M 24	M 16
ABM-IMT-7364	SK 50 / FMB 32 x 090	32	78	90	24	M 24	M 16
ABM-IMT-7365	SK 50 / FMB 40 x 060	40	90	60	27	M 24	M 20
ABM-IMT-7366	SK 50 / FMB 40 x 075	40	90	75	27	M 24	M 20
ABM-IMT-7367	SK 50 / FMB 40 x 105	40	90	105	27	M 24	M 20

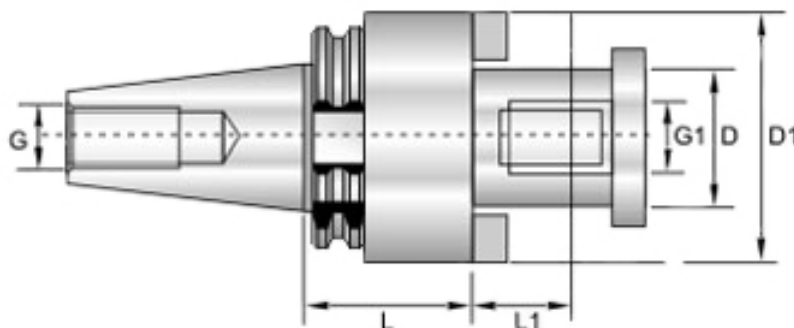

Shoulder Mill Arbor SK-DIN 69871 SK / FMC

Dimension in mm

Item Code No.	Type	D	D1	L	L1	G	G1
ABM-IMT-7390	SK 30 / FMC 22 x 045	22	40	45	19	M 12	M 10
ABM-IMT-7391	SK 40 / FMC 22 x 045	22	40	45	19	M 16	M 10
ABM-IMT-7392	SK 40 / FMC 22 x 090	22	40	90	19	M 16	M 10
ABM-IMT-7393	SK 40 / FMC 27 x 060	27	48	60	21	M 16	M 12
ABM-IMT-7394	SK 40 / FMC 27 x 090	27	48	90	21	M 16	M 12
ABM-IMT-7395	SK 40 / FMC 32 x 060	32	58	60	24	M 16	M 16
ABM-IMT-7396	SK 40 / FMC 32 x 075	32	58	75	24	M 16	M 20
ABM-IMT-7397	SK 40 / FMC 40 x 060	40	76	60	27	M 16	M 16
ABM-IMT-7398	SK 50 / FMC 22 x 060	22	40	60	19	M 24	M 10
ABM-IMT-7399	SK 50 / FMC 22 x 105	22	40	105	19	M 24	M 10
ABM-IMT-7400	SK 50 / FMC 27 x 045	27	48	45	21	M 24	M 12
ABM-IMT-7401	SK 50 / FMC 27 x 090	27	48	90	21	M 24	M 12
ABM-IMT-7402	SK 50 / FMC 27 x 150	27	48	150	21	M 24	M 12
ABM-IMT-7403	SK 50 / FMC 32 x 045	32	58	45	24	M 24	M 16
ABM-IMT-7404	SK 50 / FMC 32 x 075	32	58	75	24	M 24	M 16
ABM-IMT-7405	SK 50 / FMC 32 x 105	32	58	105	24	M 24	M 16
ABM-IMT-7406	SK 50 / FMC 40 x 060	40	76	60	27	M 24	M 20

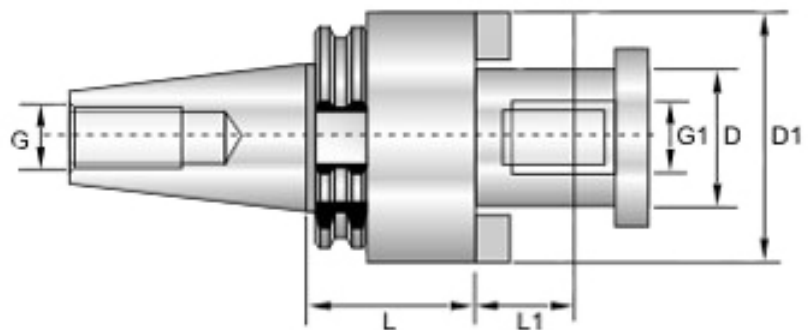

Collets & Holders

Shell End Mill Arbor SK-DIN 69871 SK / SMS

Dimension in mm

Item Code No.	Type	D	D1	L	L1	G	G1
ABM-IMT-7430	SK 30 / SMS 16 x 030	16	32	30	14	M 12	M 8
ABM-IMT-7431	SK 30 / SMS 16 x 030	22	40	30	16	M 12	M 10
ABM-IMT-7432	SK 40 / SMS 16 x 060	16	32	60	14	M 16	M 8
ABM-IMT-7433	SK 40 / SMS 16 x 120	16	32	120	14	M 16	M 8
ABM-IMT-7434	SK 40 / SMS 16 x 060	22	40	60	16	M 16	M 10
ABM-IMT-7435	SK 40 / SMS 16 x 120	22	40	120	16	M 16	M 10
ABM-IMT-7436	SK 40 / SMS 27 x 045	27	48	45	18	M 16	M 12
ABM-IMT-7437	SK 40 / SMS 27 x 105	27	48	105	18	M 16	M 12
ABM-IMT-7438	SK 40 / SMS 32 x 045	32	58	45	20	M 16	M 16
ABM-IMT-7439	SK 40 / SMS 32 x 075	32	58	75	20	M 16	M 16
ABM-IMT-7440	SK 40 / SMS 16 x 075	16	32	75	14	M 24	M 8
ABM-IMT-7441	SK 40 / SMS 16 x 120	16	32	120	14	M 24	M 8
ABM-IMT-7442	SK 50 / SMS 22 x 075	22	40	75	16	M 24	M 10
ABM-IMT-7443	SK 50 / SMS 22 x 075	22	40	120	16	M 24	M 10
ABM-IMT-7444	SK 50 / SMS 27 x 075	27	48	60	18	M 24	M 12
ABM-IMT-7445	SK 50 / SMS 27 x 075	27	48	105	18	M 24	M 12
ABM-IMT-7446	SK 50 / SMS 32 x 075	32	58	45	20	M 24	M 16
ABM-IMT-7447	SK 50 / SMS 32 x 075	32	58	75	20	M 24	M 16
ABM-IMT-7448	SK 50 / SMS 40 x 045	40	70	45	23	M 24	M 20
ABM-IMT-7449	SK 50 / SMS 40 x 075	40	70	75	23	M 24	M 20
ABM-IMT-7450	SK 50 / SMS 50 x 060	50	90	60	26	M 24	M 24

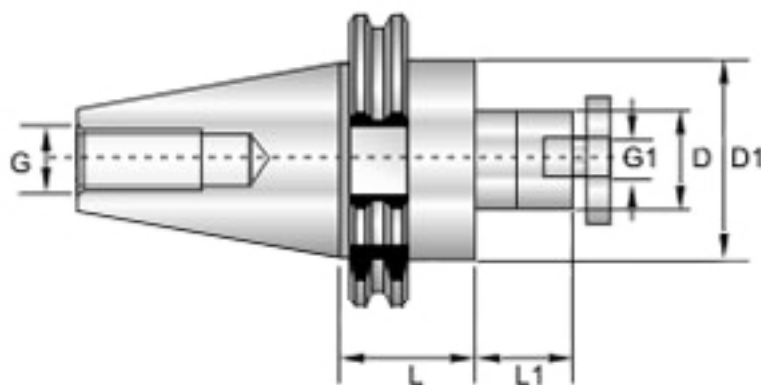

Tool Holders for Drill Chucks DIN 69871A

Dimension in mm

Item Code No.	BT Taper D	Mount D1	Draw Bar Threads G
ABM-IMT-7470	40	B16	M16
ABM-IMT-7471	40	B18	M16
ABM-IMT-7472	50	B16	M24

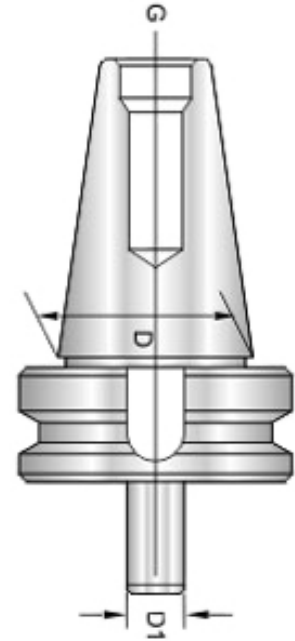

Tool Holders for Drill Chucks MAS 403 BT

Dimension in mm

Item Code No.	BT Taper D	Mount D1	Draw Bar Threads G
ABM-IMT-7480	40	B16	M16
ABM-IMT-7481	50	B16	M24

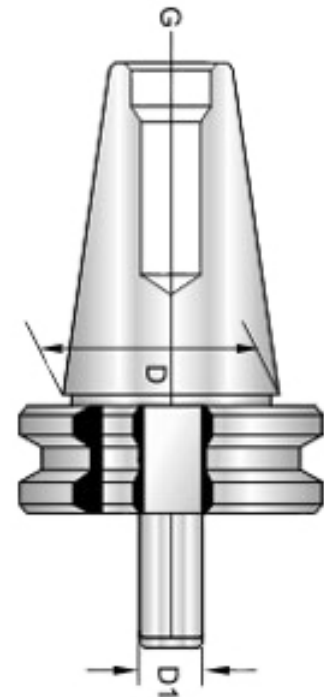

Collet Holders DIN 6327 C-Tr / ER

Dimension in mm

Item Code No.	Type A x D - L1	L	L2	G
ABM-IMT-7500	A16 x ER16A - 50	90	40	M 5 x 0.8 P
ABM-IMT-7501	A16 x ER16A - 150	190	40	M 5 x 0.8 P
ABM-IMT-7502	A20 x ER16A - 50	85	40	M 10 x 1.5 P
ABM-IMT-7503	A20 x ER20A - 60	100.5	41.5	M 12 x 1.75 P
ABM-IMT-7504	A20 x ER25A - 100	151	51	M 12 x 1.75 P
ABM-IMT-7505	A20 x ER32A - 100	151.5	51.5	M 12 x 1.75 P
ABM-IMT-7506	A25 x ER25A - 50	101	51	M 12 x 1.75 P

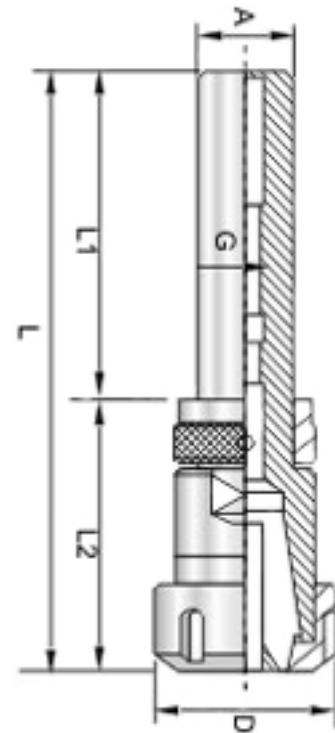

Pull Studs BT MAS 403

Dimension in mm

Item Code No.	Suitable for Tool Shank MAS 403 BT	D	D1	D2	D3	L	L1	L2	L3	L4	G	Ø°	ØA
ABM-IMT-7530	B 30	11	16.5	12.5	7	43	23	5	18	4	M 12	60	--
ABM-IMT-7531	B 30	11	16.5	12.5	7	43	23	5	18	4	M 12	45	--
ABM-IMT-7532	B 40	15	23	17	10	60	35	6	28	5	M 16	60	--
ABM-IMT-7533	B 40	15	23	17	10	60	35	6	28	5	M 16	45	--
ABM-IMT-7534	B 45	19	31	21	14	70	40	8	31	6	M 20	60	--
ABM-IMT-7535	B 45	19	31	21	14	70	40	8	31	6	M 20	45	--
ABM-IMT-7536	B 50	23	38	25	17	85	45	10	35	8	M 24	60	--
ABM-IMT-7537	B 50	23	38	25	17	85	45	10	35	8	M 24	45	--
ABM-IMT-7538	A 40	15	23	17	10	60	35	6	28	5	M 16	60	4
ABM-IMT-7539	A 40	15	23	17	10	60	35	6	28	5	M 16	45	4
ABM-IMT-7540	A 50	23	38	25	17	85	45	10	35	8	M 24	60	6

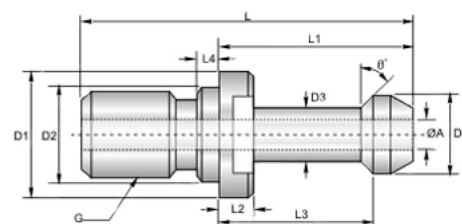
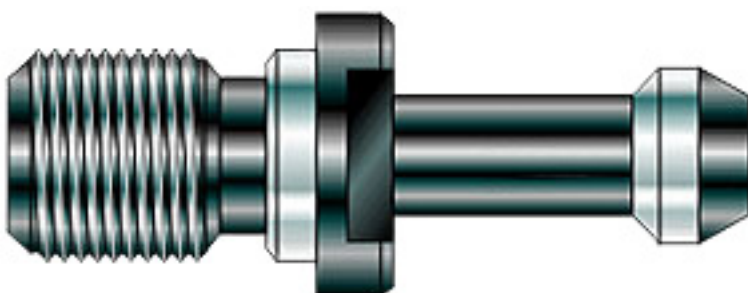

Pull Studs DIN 69872

Dimension in mm

Item Code No.	Suitable for Tool Shank DIN 69872	D	D1	D2	D3	L	L1	L2	L3	L4	G	Ø°	ØA
ABM-IMT-7570	B 40	19	23	17	14	54	26	4	20	7	M 16	75	--
ABM-IMT-7571	B 45	23	30	21	17	65	30	5	23	8	M 20	75	--
ABM-IMT-7572	B 50	28	36	25	21	74	34	5	25	10	M 24	75	--
ABM-IMT-7573	A 40	19	23	17	14	54	26	4	20	7	M 16	75	7
ABM-IMT-7574	A 45	23	30	21	17	65	30	5	23	8	M 20	75	9.5
ABM-IMT-7575	A 50	28	36	25	21	74	34	5	25	10	M 24	75	11.5

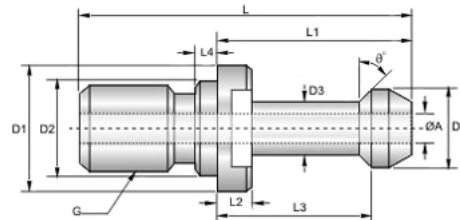
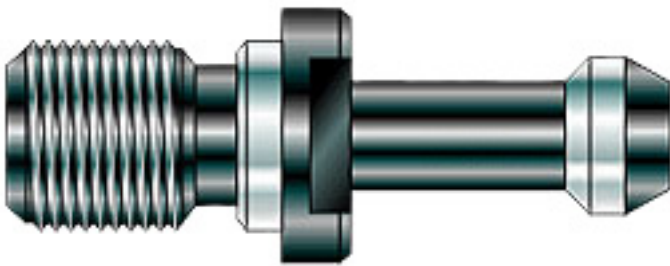

Pull Studs ISO 7388 B

Dimension in mm

Item Code No.	Suitable for Tool Shank ISO 7388 B	D	D1	D2	D3	L	L1	L2	L3	L4	G	Ø°	ØA
ABM-IMT-7590	B 40	18.95	22.5	17	12.95	44.5	16.4	3.25	11.15	7	M 16	45	--
ABM-IMT-7591	B 45	24.05	30	21	16.3	56	20.95	4.25	14.85	8	M 20	45	--
ABM-IMT-7592	B 50	29.10	37	25	19.6	65.5	25.55	5.25	17.95	10	M 24	45	--
ABM-IMT-7593	A 40	18.95	22.5	17	12.95	44.5	16.40	3.25	11.15	7	M 16	45	7.35
ABM-IMT-7594	A 45	24.05	30	21	16.3	56	20.95	4.25	14.85	8	M 20	45	9.25
ABM-IMT-7595	A 50	29.10	37	25	19.6	65.5	25.55	5.25	17.95	10	M 24	45	11.55

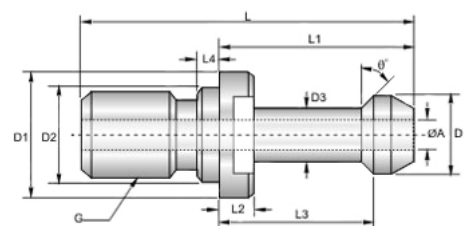
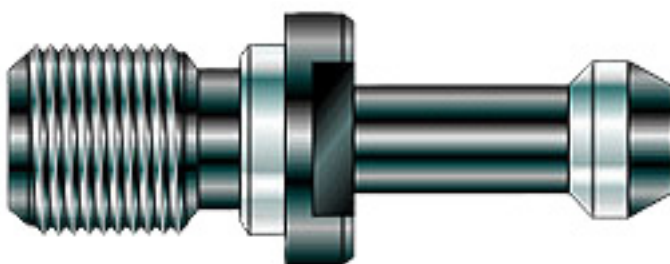

Assembling AIDS

- Type : Rotational, for assembling Tools without reclamping.
- Application : For assembling and disassembling of ST types tool holder

Dimension in mm

Item Code No.	Mount ST	Length	Width
ABM-IMT-7620	40	180	80
ABM-IMT-7621	50	233	98



ER Wrenches System DIN 6499

- Tightening wrenches for heavy milling collet chucks.

Dimension in mm

Item Code No.	Type	A	L
ABM-IMT-7640	ER 25T	65	205
ABM-IMT-7641	ER 32T	75	245
ABM-IMT-7642	ER 40T	90	292
ABM-IMT-7643	ER 50T	110	345

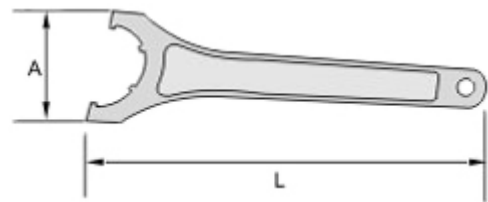

ER Mini Wrenches

Dimension in mm

Item Code No.	Type	A	L
ABM-IMT-7660	ER 11M	16.5	100
ABM-IMT-7661	ER 16M	22.5	130
ABM-IMT-7662	ER 20M	26	140
ABM-IMT-7663	ER 25M	29.5	160
ABM-IMT-7664	ER 32M	37.5	195

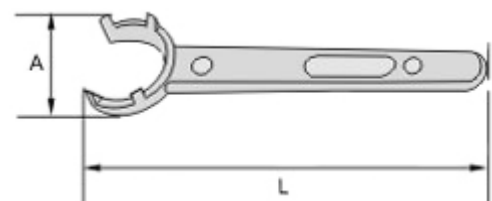

5C Collet Fixture

Item Code No.

ABM-IMT-8690



- 5C collet for secure & accurate milling, tapping, drilling, reaming, grinding & slotting etc.
- Can be Mounted on any angle plate, for vertical & Horizontal use.
- You can Use any standard 5C collet for a capacity 1-1/8" round.
- Base Dimension: 4-1/4" x 5" (108 mm x 127 mm)
- Overall Height : 4-1/4" (108 mm)

5C Collet Fixture H & V

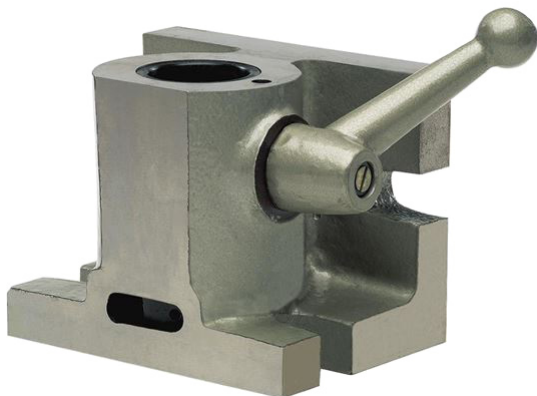

Item Code No.

ABM-IMT-8670

- 5C collet Fixture used for secure & accurate milling, tapping, drilling, reaming, grinding & slotting etc.
- Can be Mounted on any angle plate, for vertical & Horizontal use.
- Uses any standard 5C collet for a capacity 1-1/8" round.
- Base Size: 4-1/4" x 5" (108 mm x 127 mm)
- Height : 4-1/4" (108 mm)

An indispensable fixture with cam-operated sleeve for opening and closing the collet.

The collet remains in a fixed position for positive depth control.

The spring-loaded handle can be indexed to any desired position for ease of operation while mounted vertically or horizontally.

BT 40 Tool Holder Locking Device

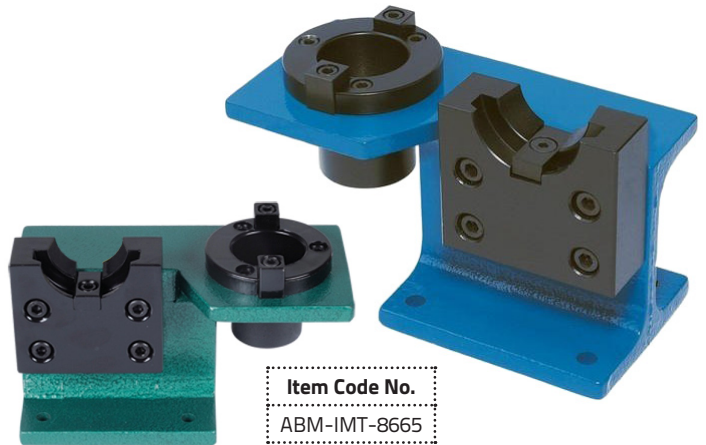

Item Code No.

ABM-IMT-8665

- Accepts both imperial & metric sized tool.
- Presence of BT 40 makes it Symmetrical about the spindle axis.
- Having greater stability & more balance at high speeds.
- Tool Holder Bearing Lock Knife Seat Block Locking Device BT40 Ball Lock Cutter For Automatic Tool Change Cutting

Quick Change Chuck Adapter

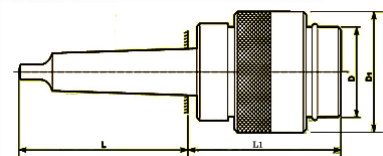

Made from 20MnCr5 & Case Hardened to 55-58 HRC.

Item Code No.	ABM-IMT-7677	ABM-IMT-7678	ABM-IMT-7679	ABM-IMT-7680
Size	MT2	MT3	MT4	MT5
L mm	75	94	117.5	149.5
L1 mm	75	86	97.5	122.5
Bore Size mm	26	34	46	60
D mm	36	46	62	80
D1 mm	48	61	85	104
D2 mm	17.780	23.825	31.267	44.399
Suitable for Collets	CO 21, 22	CO 31, 32, 33	CO 41, 42, 43, 44	CO 51, 52, 53, 54, 55

Collet Spanner

▪ For ER25 / ER32 Collet Holders.

Item Code No.	Type
ABM-IMT-8400	ER 25
ABM-IMT-8401	ER 32



ER Spring Collet Sets

- ER COLLET SYSTEM provides an advantage of holding any type of round shank tool.
- ER COLLET can be used in tapping, reaming, drilling etc.
- Provides high accuracy.

Item Code No.	Model	No. of Pcs.	Clamping Range mm
ABM-IMT-8391	ER 25	15 Pcs.	2 - 16
ABM-IMT-8392	ER 32	19 Pcs.	2 - 20



Collet Holders

- Collet chuck use for holding collet.

Dimension in mm

Item Code No.	Shank	Collet Type	Drawbar	Overall Length
ABM-IMT-8375	MT0	ER16	M5	92 mm
ABM-IMT-8376	MT2	ER25	M10	120 mm
ABM-IMT-8377	MT3	ER25	M12	135 mm
ABM-IMT-8378	MT4	ER25	M16	150 mm
ABM-IMT-8379	20 mm ST.	ER25	--	151 mm
ABM-IMT-8380	25 mm ST.	ER25	--	101 mm
ABM-IMT-8381	R8	ER32	7/16" UNF	172 mm



Collets & Adapter Sets

Collet set adapter and spanner set for various spindle noses R8, MT3, MT40, ISO30, ISO40



Item Code No.	Sets Description
ABM-IMT-7670	Set BT-40-ES-32 (3 to 20mm) Set of 11 Collets + One Adaptor + One Spanner (3,4,5,6,8,10,12,14,16,18,20)
ABM-IMT-7671	Set BT-40-ES-40 (5 to 25mm) Set of 12 Collets + One Adaptor + One Spanner (5,6,8,10,12,14,16,18,20,22,24,25)
ABM-IMT-7672	Set ISO-40-ER-40 (5 to 25mm) Set of 12 Collets + One Adaptor + One Spanner (5,6,8,10,12,14,16,18,20,22,24,25)
ABM-IMT-7673	Set ISO-40-ER-40 Tail (5 to 25mm) Set of 12 Collets + One Adaptor + One Spanner (5,6,8,10,12,14,16,18,20,22,24,25)
ABM-IMT-7674	Set ISO-40-ER-40 Schaublin (5 to 25mm) Set of 12 Collets + One Adaptor + One Spanner (5,6,8,10,12,14,16,18,20,22,24,25)

Adjustable Bevels



- Polished Wood Stock.
- With Solid Brass Fitting.
- With Forged Brass Wing Nut & Tips.
- Chemically Blacked Steel blades.
- Fully Adjustable To Any Angle For Marking, Checking Or Transferring Angle.
- For Use on Inside or Outside Corners For Perfect Layout.
- Hardened steel blade for holding angles between 0° and 180°.
- It locks with the wing nut

Item Code No.	Size	
	MM	Inch
ABM-WWT-7900	75	3"
ABM-WWT-7901	190	7-1/2"
ABM-WWT-7902	225	9"
ABM-WWT-7903	265	10-1/2"

Sliding T Bevel Aluminium



- An Adjustable Gauge for setting & transferring angels.
- Stainless Steel Blade & Heavy Duty Aluminium Handel.

Item Code No.	Size	
	MM	Inch
ABM-EPT-9710	200	8"
ABM-EPT-9711	250	10"
ABM-EPT-9712	300	12"

Carpenter Try Square

Cast Iron

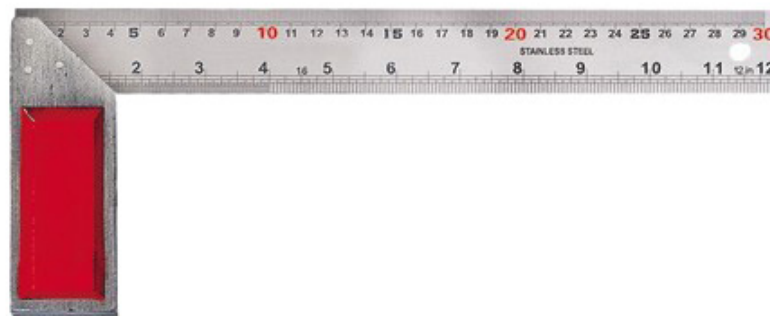

- Carbon steel blade.
- Graduation in Cms / Inches.
- Made of Cast Iron.
- Graduation available on Single Side / Both Side.
- While placing order please mention Graduation Single or Both Side.

Item Code No.	Size	
	Inch	mm
ABM-EPT-7810	6	150
ABM-EPT-7811	8	200
ABM-EPT-7812	9	225
ABM-EPT-7813	10	250
ABM-EPT-7814	12	300
ABM-EPT-7815	14	350
ABM-EPT-7816	16	400
ABM-EPT-7817	18	450



Combination Square

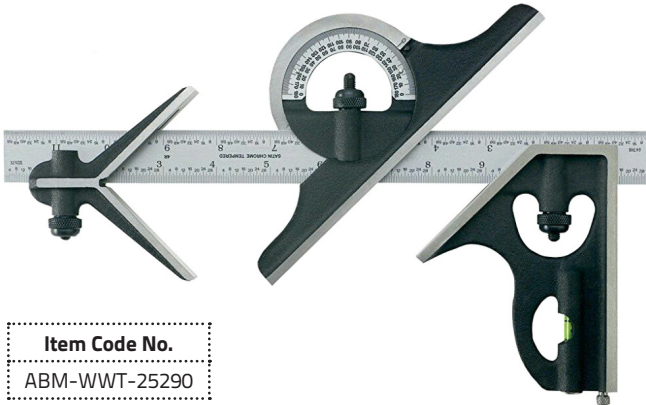

Item Code No.
ABM-WWT-25290

- Made from Workshop grade squareness standards having a black wrinkled finished on the machined cast iron heads.
- Hardened and Tempered blade has imperial and metric readings.
- It slides in a cast iron stock with machines 45 Degree and 90 Degree Faces.
- Useful for Mechanics, toolmakers and pattern makers.
- Compact design small size and light weight.
- Size 12" / 300 mm

Adjustable Steel Square

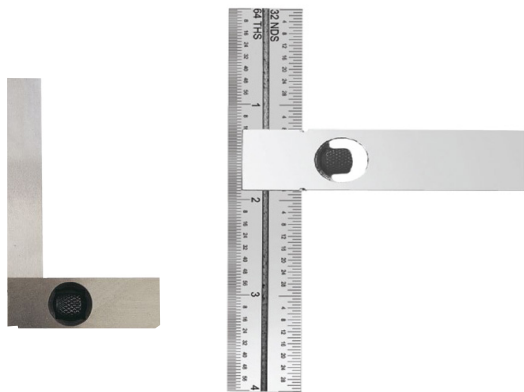

- Especially used to check squareness in places where conventional squares cannot be used.
- Working faces/ blades are hardened and ground for Straightness & parallelism.
- Supplied with two blades, one with square ends, the other with a 45 degree on one end and 30 degree on the other end and a 100 mm steel rule.
- Easy to operate knurled lock nut for setting the stock in any position.
- Stock is Precision Ground.
- Can be used for many applications as compared to the conventional square, which comes with a fixed stock.

Item Code No.	Height	
	Inch	MM
ABM-EPT-8550	4	100
ABM-EPT-8551	6	150

Precision Steel Squares Engineers



Sets also Available

- Available in 'A' Grade & 'Workshop' Grade.
- Made of finest quality ground steel with heavy thick stock.
- Blade is hardened and ground for straightness and parallelism.
- Squares are accurate both inside and outside.
- Sizes 18" (450 mm) and above are supplied in finished wooden box.
- Effective Blade length measured from inner edge of the beam of the blade and is approximately 1/4" (6 mm) more than sizes shown.
- Available in DIN 875/II, 875/I or BS939B.

Item Code No.	Blade Length		Stock Length	
	Inch	MM	Inch	mm
ABM-EPT-8570	1	25	1-1/2	38
ABM-EPT-8571	2	50	2	50
ABM-EPT-8572	3	75	2-1/2	63
ABM-EPT-8573	4	100	3	75
ABM-EPT-8574	5	125	3-1/2	89
ABM-EPT-8575	6	150	4	100
ABM-EPT-8576	8	200	5	125
ABM-EPT-8577	9	225	6	150
ABM-EPT-8578	10	250	6	150
ABM-EPT-8579	12	300	8	200
ABM-EPT-8580	18	450	10	250
ABM-EPT-8581	24	600	13	330
ABM-EPT-8582	36	915	17-1/2	445

ABM-EPT-9518 Set of 4 pcs
2", 3", 4" & 6"

While placing order please mention 'A' Grade or Workshop Grade

Sets also available as per desired sizes

Bevelled Edge Steel Squares



- Blades beveled on both sides to make line contact with job.
- Both Blade & Stock is Hardened & ground for straightness & parallelism.
- Single piece construction from fine quality tool steel.
- Accuracy within 5 microns.
- Sets Supplied in Fine Finished Wooden Boxes.

Item Code No.	Blade Length		Stock Length	
	Inch	mm	Inch	mm
ABM-EPT-9701	2"	50	1-1/2"	38.5
ABM-EPT-9702	3"	75	2"	50
ABM-EPT-9703	4"	100	2-3/4"	70
ABM-EPT-9704	6"	150	3-3/16"	97
ABM-EPT-9705	8"	200	5-1/8"	130
ABM-EPT-9706	2 Pc Set of 2" & 4"			
ABM-EPT-9707	3 Pc Set of 4", 6" & 8"			

Beam Trammel



- Useful instrument for draftsmen.
- Tool makers and Machinists with fine adjustments for accurate layout work.
- Special sizes also available on Order.

Item Code No.	Beam Size		Scribes Size	
	Inch	MM	Inch	MM
ABM-EPT-7930	10-1/2	265	18	450
ABM-EPT-7931	14-1/2	365	26	650
ABM-EPT-7932	20	500	36	900

Precision Steel Squares

Flat & Back Base

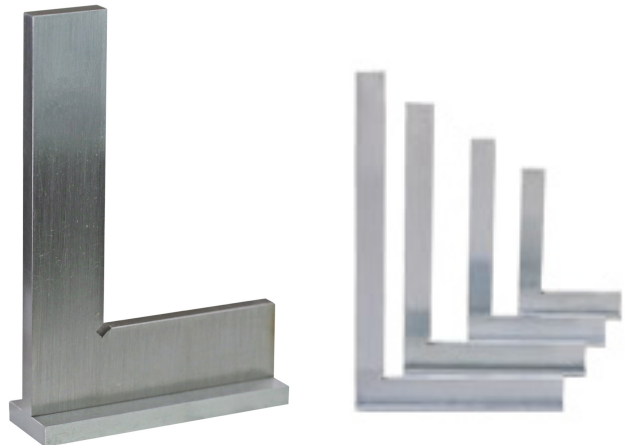

PLATED STEEL SQUARES CONTROL STEEL SQUARES

- Made from Special Steel.
- Ground and then Zinc Coated to prevent Rust.
- Dimensions as per DIN 875 standard.
- Available in Flat style and with Back (with and without base).

Flat Base Item Code No.	Back Base Item Code No.	Size mm L1 x L2
ABM-EPT-8508	ABM-EPT-8510	50 x 40
ABM-EPT-8509	ABM-EPT-8511	75 x 50
ABM-EPT-8500	ABM-EPT-8520	100 x 70
ABM-EPT-8501	ABM-EPT-8521	150 x 100
ABM-EPT-8502	ABM-EPT-8522	200 x 130
ABM-EPT-8503	ABM-EPT-8523	250 x 165
ABM-EPT-8504	ABM-EPT-8524	300 x 200
ABM-EPT-8505	ABM-EPT-8525	400 x 230
ABM-EPT-8506	ABM-EPT-8526	500 x 330
ABM-EPT-8507	ABM-EPT-8527	600 x 330

Trammel Point Set

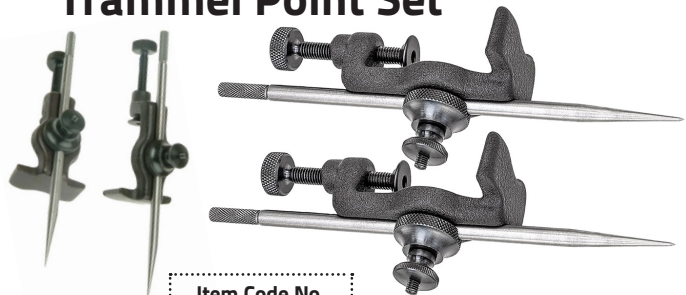

Item Code No.
ABM-EPT-10050

- Trammel Points to make circles and arcs of any diameter from 3" (75 mm) to a big room size.
- Accepts any beam size upto 1-1/2" wide, & hardened steel 6" scribing sharpened pins.
- A pencil may be substituted for any of the pin in the set.

Measuring & Marking Tools



Trammel Set - 2 Pcs.



Item Code No.
ABM-WWT-7905

- Zinc Die Cast Body.
- used for Scribing Parallel Lines, Circles & Arcs.
- Radius Lengths as required with your own made beams.
- Knurled screws width 3/8 (10 mm) to 1-1/4 (32 mm).
- With Pencil Holder.

Firm Joint (Odd Leg) Jenny Callipers

- These are supplied with one end straight and one end bent.
- Polish Finish.
- Used in Layout works for locating and testing centres.
- Properly shaped and finished legs.



Item Code No.	Size	
	MM	Inch
ABM-EPT-8040	100	4
ABM-EPT-8041	150	6
ABM-EPT-8042	200	8
ABM-EPT-8043	250	10
ABM-EPT-8044	300	12
ABM-EPT-8045	450	18
ABM-EPT-8046	600	24

Firm Joint Callipers & Dividers



- Legs machined to rigid and balance.
- Polish finish

Divider Item Code No.	Inside Callipers Item Code No.	Outside Callipers Item Code No.	Size	
			Inch	MM
ABM-EPT-7960	ABM-EPT-7990	ABM-EPT-8010	4	100
ABM-EPT-7961	ABM-EPT-7991	ABM-EPT-8011	6	150
ABM-EPT-7962	ABM-EPT-7992	ABM-EPT-8012	8	200
ABM-EPT-7963	ABM-EPT-7993	ABM-EPT-8013	10	250
ABM-EPT-7964	ABM-EPT-7994	ABM-EPT-8014	12	300
ABM-EPT-7965	ABM-EPT-7995	ABM-EPT-8015	16	400
ABM-EPT-7967	ABM-EPT-7997	ABM-EPT-8017	18	450
ABM-EPT-7968	ABM-EPT-7998	ABM-EPT-8018	20	500
ABM-EPT-7969	ABM-EPT-7999	ABM-EPT-8019	24	600
ABM-EPT-7970	ABM-EPT-8000	ABM-EPT-8020	36	900
ABM-EPT-7971	ABM-EPT-8001	ABM-EPT-8021	40	1000

Spring Callipers & Dividers Premium Quality



- Professional Grade dividers and calipers with rugged construction.
- Used for checking dimensions with rule, Vernier or micrometer and transferring measurements carbon steel legs.
- Hardened and ground measuring points hardened to 35 HRS.
- Quick spring Nut for making quick positive adjustments.
- Chrome Plated Fittings and Black Finish.
- Also available in any color Powder Coating.

Divider Item Code No.	Inside Callipers Item Code No.	Outside Callipers Item Code No.	Size	
			Inch	MM
ABM-EPT-8170	ABM-EPT-8175	ABM-EPT-8180	4	100
ABM-EPT-8171	ABM-EPT-8176	ABM-EPT-8181	6	150
ABM-EPT-8172	ABM-EPT-8177	ABM-EPT-8182	8	200
ABM-EPT-8173	ABM-EPT-8178	ABM-EPT-8183	10	250
ABM-EPT-8174	ABM-EPT-8179	ABM-EPT-8184	12	300

Measuring & Marking Tools

Wing Compass

- Heavy duty with cast alloy Body.
- Hardened steel Points.
- Fully Polished.

Item Code No.	Size	
	Inch	MM
ABM-EPT-8190	6	150
ABM-EPT-8191	8	200
ABM-EPT-8192	10	250
ABM-EPT-8193	12	300
ABM-EPT-8194	18	450
ABM-EPT-8195	24	600



Wing Compass (German Type , Square Leg)

- High Quality Thick Dividers.
- Square Legs for Balance and Grip.
- Hardened and Ground Points.
- Manufactured with Rivet or Screw Hinge.



Woodworking Callipers



Woodturner's calipers which allow the measurement of internal and external diameters as well as the ability to measure wall thickness. A reading at one end is accurately transferred to the other end.

Item Code No.	Name of Item	Size	
		Inch	MM
ABM-WWT-25111	Double Ended Outside	7	175
ABM-WWT-25112	Inside & Outside	9	225
ABM-WWT-25113	Inside & Outside	7	175
ABM-WWT-25114	Inside & Outside	4	100
ABM-WWT-25115	Double Ended Outside	6	150
ABM-WWT-25116	Double Ended Outside	6	150
ABM-WWT-25117	Inside & Outside	8	200
ABM-WWT-25118	Inside & Outside	10	250
ABM-WWT-25119	Inside & Outside	12	300

Style A Item Code No.	Style B Item Code No.	Size	
		Inch	MM
ABM-EPT-8220	ABM-EPT-8240	6	150
ABM-EPT-8221	ABM-EPT-8241	7	175
ABM-EPT-8222	ABM-EPT-8242	8	200
ABM-EPT-8223	ABM-EPT-8243	10	250
ABM-EPT-8224	ABM-EPT-8244	12	300
ABM-EPT-8225	ABM-EPT-8245	16	400
ABM-EPT-8226	ABM-EPT-8246	20	500
ABM-EPT-8227	ABM-EPT-8247	24	600
ABM-EPT-8228	ABM-EPT-8248	32	800
ABM-EPT-8229	ABM-EPT-8249	40	1000

Woodworking Callipers

Brass Wing Nut



Woodturner's calipers which allow the measurement of internal and external diameters as well as the ability to measure wall thickness. A reading at one end is accurately transferred to the other end.

Item Code No.	Name of Item	Size	
		Inch	MM
ABM-WWT-25125	Double Ended	4	100
ABM-WWT-25126	Inside & Outside	6	150
ABM-WWT-25127	Double Ended	7	175
ABM-WWT-25128	Inside & Outside	8	200
ABM-WWT-25129	Inside & Outside	9	225
ABM-WWT-25130	Double Ended	7	175

Spring Callipers & Dividers (Flat Leg)



- Spring is hardened & tempered.
- Solid nut and washer permits fast and positive adjustments.
- Made of high grade polished steel, Heat Treated points.
- Legs well balanced & uniform tension and polished finish.
- All callipers & dividers are measured from joint to the point.

Divider Item Code No.	Inside Callipers Item Code No.	Outside Callipers Item Code No.	Size	
			Inch	MM
ABM-EPT-8080	ABM-EPT-8090	ABM-EPT-8100	3	75
ABM-EPT-8081	ABM-EPT-8091	ABM-EPT-8101	4	100
ABM-EPT-8082	ABM-EPT-8092	ABM-EPT-8102	5	125
ABM-EPT-8083	ABM-EPT-8093	ABM-EPT-8103	6	150
ABM-EPT-8084	ABM-EPT-8094	ABM-EPT-8104	8	200
ABM-EPT-8085	ABM-EPT-8095	ABM-EPT-8105	10	250
ABM-EPT-8086	ABM-EPT-8096	ABM-EPT-8106	12	300
ABM-EPT-8087	ABM-EPT-8097	ABM-EPT-8107	18	450
ABM-EPT-8088	ABM-EPT-8098	ABM-EPT-8108	24	600
ABM-EPT-8089	ABM-EPT-8099	ABM-EPT-8109	36	900

Quick Release Callipers (German Type) (Square Leg Spring Divider) (Precision)



- Professional Grade dividers and calipers with rugged construction.
- Legs made from heavy square stock machines to smooth taper.
- Hardened and ground measuring points, Heat Treated points.
- Quick spring Nut for making quick positive adjustments.

Divider Item Code No.	Inside Callipers Item Code No.	Outside Callipers Item Code No.	Size	
			Inch	MM
ABM-EPT-8130	ABM-EPT-8141	ABM-EPT-8152	3	75
ABM-EPT-8131	ABM-EPT-8142	ABM-EPT-8153	4	100
ABM-EPT-8132	ABM-EPT-8143	ABM-EPT-8154	5	125
ABM-EPT-8133	ABM-EPT-8144	ABM-EPT-8155	6	150
ABM-EPT-8134	ABM-EPT-8145	ABM-EPT-8156	8	200
ABM-EPT-8135	ABM-EPT-8146	ABM-EPT-8157	9	225
ABM-EPT-8136	ABM-EPT-8147	ABM-EPT-8158	10	250
ABM-EPT-8137	ABM-EPT-8148	ABM-EPT-8159	12	300
ABM-EPT-8138	ABM-EPT-8149	ABM-EPT-8160	16	400
ABM-EPT-8139	ABM-EPT-8150	ABM-EPT-8161	20	500
ABM-EPT-8140	ABM-EPT-8151	ABM-EPT-8162	40	1000

Wing Compass (German Type, Square Leg)

Square Leg Pencil Holders - Heavy Duty

- High Quality Thick Dividers.
- Square Legs for Balance and Grip.
- Hardened and Ground Points.
- Manufactured with Rivet or Screw Hinge.
- While Placing order please mention One Point or Two Point Compass

Rivet Joint Wing Item Code No.	Screw Hinge Item Code No.	Size	
		Inch	MM
ABM-EPT-8290	ABM-EPT-8310	6	150
ABM-EPT-8291	ABM-EPT-8311	7	175
ABM-EPT-8292	ABM-EPT-8312	8	200
ABM-EPT-8293	ABM-EPT-8313	10	250
ABM-EPT-8294	ABM-EPT-8314	12	300
ABM-EPT-8295	ABM-EPT-8315	16	400
ABM-EPT-8296	ABM-EPT-8316	20	500
ABM-EPT-8297	ABM-EPT-8317	24	600
ABM-EPT-8298	ABM-EPT-8318	32	800
ABM-EPT-8299	ABM-EPT-8319	40	1000

While Placing order please mention One Point or Two Point Compass



Hermaphrodite Callipers

A hermaphrodite caliper has one leg bent inward and one straight leg ending in a sharp point; this type of caliper is used for scribing lines at a specified distance from a flat or curved surface.

- Used in layout works for locating and testing centres
- Properly shaped and finished legs.

Item Code No.	Size
ABM-EPT-8060	4" Hermaphrodite Calliper
ABM-EPT-8061	6" Hermaphrodite Calliper
ABM-EPT-8062	8" Hermaphrodite Calliper



Spring Divider Interchangeable Points

- Manufactured from forged steel.
- Thick square legs.
- Quick release nut.
- Have interchangeable Points

Item Code No.	Size	
	Inch	MM
ABM-EPT-9830	3	75
ABM-EPT-9831	4	100
ABM-EPT-9832	5	125
ABM-EPT-9833	6	150
ABM-EPT-9834	7	175
ABM-EPT-9835	8	200
ABM-EPT-9836	10	250
ABM-EPT-9837	12	300
ABM-EPT-9838	20	500



Compass with Pencil Holder

- Made from High Quality steel.
- Hardened and Ground Points.
- Spring is hardened and tempered.
- Fully Polished.
- Ideal tool for laying out the distance between two points and marking areas and circles.

Item Code No. Flat Leg Single Point	Item Code No. Flat Leg Double Point	Item Code No. Square Leg Single Point	Item Code No. Square Leg Double Point	Size	
				Inch	MM
ABM-EPT-9790	ABM-EPT-9800	ABM-EPT-9810	ABM-EPT-9820	6	150
ABM-EPT-9791	ABM-EPT-9801	ABM-EPT-9811	ABM-EPT-9821	8	200
ABM-EPT-9792	ABM-EPT-9802	ABM-EPT-9812	ABM-EPT-9822	10	250
ABM-EPT-9793	ABM-EPT-9803	ABM-EPT-9813	ABM-EPT-9823	12	300
ABM-EPT-9794	ABM-EPT-9804	ABM-EPT-9814	ABM-EPT-9824	18	450
ABM-EPT-9795	ABM-EPT-9805	ABM-EPT-9815	ABM-EPT-9825	24	600



Wing Compass With & Without Pencil Holder

- Heavy duty High Quality Thick Dividers.
- Hardened and Ground Points.
- Available with Rivet or Screw Hing.
- Square Legs for Balance and Grip.
- Available with and without pencil holder.
- Fully Polished.
- While Placing order placing mention with or without Pencil Holder

Pencil Holder Item Code No.	Without Pencil Holder Item Code No.	Size	
		Inch	MM
ABM-EPT-8198	ABM-EPT-8207	6	150
ABM-EPT-8199	ABM-EPT-8208	8	200
ABM-EPT-8200	ABM-EPT-8209	10	250
ABM-EPT-8201	ABM-EPT-8210	12	300
ABM-EPT-8202	ABM-EPT-8211	14	350
ABM-EPT-8203	ABM-EPT-8212	16	400
ABM-EPT-8204	ABM-EPT-8213	18	450
ABM-EPT-8205	ABM-EPT-8214	20	500
ABM-EPT-8206	ABM-EPT-8215	24	600





Zero Point Setter

- Available in Non Magnetic and Magnetic Grip.
- Useful for fast and easy locating of the reference point in axial direction of the machine spindle.
- When the setter is positioned on to the workpiece and the tool is moved to the spring based probe surface till the zero position is reached, the distance between the tool tip to workpiece is 50 mm.

Non Magnetic Item Code No.	Magnetic Grip Item Code No.
ABM-EPT-8805	ABM-EPT-8810



Economy Micrometer



- Available in Metric and Inch sizes.
- Best for hobbyists and for general use.
- Very handy tool for measuring.

Item Code No.	Range
ABM-EPT-8620	0 - 1"
ABM-EPT-8621	0 - 25 mm

Micrometer Stand Base (Standard)



Item Code No.
ABM-EPT-8630

- An indispensable clamping device for precise and stand measurements.
- Most useful to speed up production and quality inspection.
- Provides desirable measuring position and angle for measurement.
- Allows clamping and positioning of the micrometer with a single clamp
- Diameter of Base 4-3/8" (110 mm).
- Holding Capacity 9/16" (15 mm)

Brass Vernier Callipers

Sliding Gauge Brass



- Stepped Jaw construction for Inside & Outside measurement.
- Graduated in mm. and inch sizes.
- Made of Brass.
- Laser etched fine marking for better readouts.

Item Code No.	Size	
	MM	Inch
ABM-EPT-7939	0 - 60	0 - 2-1/2"
ABM-EPT-7940	0 - 75	0 - 3"
ABM-EPT-7941	0 - 100	0 - 4"

Brass Vernier Callipers

(Sliding Gauge Brass) Round Jaws

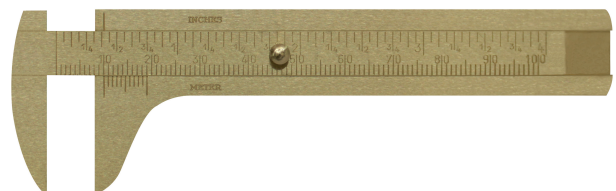

- Round Jaws construction for Inside & Outside measurement.
- Graduated in mm. and inch sizes.
- Made of Brass.
- Laser etched fine marking for better readouts.

Item Code No.	Size	
	MM	Inch
ABM-EPT-7949	0 - 60	0 - 2-1/2"
ABM-EPT-7950	0 - 75	0 - 3"
ABM-EPT-7951	0 - 100	0 - 4"

Measuring & Marking Tools

Vernier Callipers



- Graduated in m.m. and inch sizes.
- Handy Tool for measuring Inside, Outside and Depth.
- Thumb control with Locking Device.
- Columbus Type features thumb controlled movement with locking device.
- Moderately priced. Best for hobbist and for general use.

Item Code No.	Size	
	Inch	mm
ABM-WWT-7950	0 - 5"	0 - 125
ABM-WWT-7951	0 - 6"	0 - 150

Dial Comparator Stand (Fine Adjustments)

- Compact and Versatile Comparator Stand.
- Rugged Enameled Cast Iron base.
- Rust Proof chrome plated Pillar at right angle to the base.
- Hardened and Precise ground Anvil.
- Provided with fine Adjustment Knob for Zero Setting.
- Suitable for all dial gages including 3/8" and 5/16" dia stem.
- Base Dimension : 5" x 4" (125 x 100mm).
- Pillar diameter : 1" (25.4 mm).
- Supplied without Dial Gage.



Item Code No.	Description	Anvil Size		Throat Depth		Measuring Range		Fine Adjustments	
		Inch	mm	Inch	mm	Inch	mm	Inch	mm
ABM-EPT-8600	Round Serrated	2-3/8	60	3	75	5	125	1/8	3
ABM-EPT-8601	Round Flat	2-3/8	60	3	75	5	125	1/8	3
ABM-EPT-8602	Square Flat	2-3/8	60	3	75	5	125	1/8	3
ABM-EPT-8603	Square Serrated	2-3/8	60	3	75	5	125	1/8	3
ABM-EPT-8604	Round Serrated	2-3/8	60	3	75	11	280	1/8	3
ABM-EPT-8605	Round Flat	2-3/8	60	3	75	11	280	1/8	3
ABM-EPT-8606	Square Flat	2-3/8	60	3	75	11	280	1/8	3
ABM-EPT-8607	Square Serrated	2-3/8	60	3	75	11	280	1/8	3

Machinist Scraper



- Extremely useful accessory for scraping.
- Made of hardened and tempered steel.
- Available in Triangular, Flat and Half Round shapes.
- Set Consists of one Triangular, Flat and Half Round shape.

Item Code No.	Styles	Size	
		Inch	mm
ABM-EPT-8730	Triangular	4	100
ABM-EPT-8731	Flat	4	100
ABM-EPT-8732	Half Round	4	100
ABM-EPT-8733	Triangular	6	150
ABM-EPT-8734	Flat	6	150
ABM-EPT-8735	Half Round	6	150
ABM-EPT-8736	Triangular	8	200
ABM-EPT-8737	Flat	8	200
ABM-EPT-8738	Half Round	8	200
ABM-EPT-8739	Triangular	10	250
ABM-EPT-8740	Flat	10	250
ABM-EPT-8741	Half Round	10	250
ABM-EPT-8742	Half Round	12	300
ABM-EPT-8743	Triangular	12	300
ABM-EPT-8744	Flat	12	300
ABM-EPT-8745	3 Pcs Set of 4" Flat, Triangular & Half Round		
ABM-EPT-8746	3 Pcs Set of 6" Flat, Triangular & Half Round		
ABM-EPT-8747	3 Pcs Set of 8" Flat, Triangular & Half Round		
ABM-EPT-8748	3 Pcs Set of 10" Flat, Triangular & Half Round		
ABM-EPT-8749	3 Pcs Set of 12" Flat, Triangular & Half Round		

Triangular Scraper



- Very popular small tool.
- Useful for scraping, trimming and deburring metals, tubing and other material.
- Hardened and Tempered
- Triple edge Blade is secured in wooden handle with steel ferrule.
- Available with Solid Cutting Edge as well as Hollow Ground Cutting Edges.

Item Code No.	Description
ABM-EPT-8840	Hollow Ground Cutting Edges
ABM-EPT-8841	Solid Cutting Edges

Adjustable Scraper & Deburring Tool



Item Code No.
ABM-EPT-10040

- Hardened high speed steel (HSS) blades, adjustable for best suited working length.
- Triangular Blade profile.
- Bull nose collet face serves as a non-marring edge guide.
- Good balanced, & comfortable hand grip , 4-1/2" length.

Scribers / Scrapers

(a) Scriber / Scraper (Marking Knife Scriber)



- **ITEM CODE NO. ABM-EPT-8650**
- Made from Tool Steel, both end hardened.
- One end chisel.
- Overall Length 7" (175 mm).

(b) Pocket Scraper

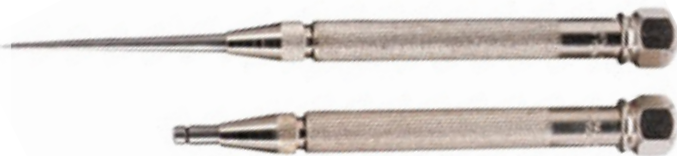

- **ITEM CODE NO. ABM-EPT-8655**
- Replaceable hardened and center less ground point.
- Point reverses into knurled body for safety.
- Overall Length 5-7/8" (147 mm).

(c) Single Point Scriber



- **ITEM CODE NO. ABM-EPT-8700**

(d) Two Point Scriber



- **ITEM CODE NO. ABM-EPT-8670**
- This scriber consists of short straight and short end points.
- Overall Length 9" (225 mm).

(e) Three Point Scriber



- **ITEM CODE NO. ABM-EPT-8665**
- Steel knurled body, with three interchangeable threaded points, Short Straight, Short bent and Long bent.
- Overall Length of tool with two short point is 9" (225 mm) and with one short and one long point is length 12" (300 mm).

(f) Carbide Scraper



- Can be used on hard surfaces.
- Long life, fixed points. 6" Long.
- Available in Plastic and Steel body.

Item Code No.	Description
ABM-EPT-8680	Plastic body
ABM-EPT-8685	Steel Body

Scribers / Scrapers

(g) Pocket Scraper - Eclipse Type

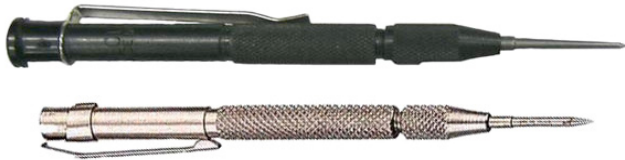

Item Code No.

ABM-EPT-8660

- Hardened, Tempered Point.
- Overall Length 5-7/8" (147 mm).

(h) Two Fixed Point Scriber



- **ITEM CODE NO. ABM-EPT-8675**
- Hardened and ground steel needle points are fixed to a knurled body, has one straight point and one bent point.
- Overall Length 7-1/2" (190 mm), 8-1/2" (212 mm.)

Steel Rules

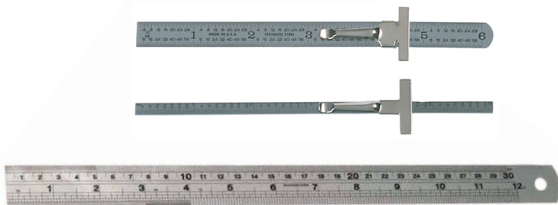

- Made from Stainless Steel.
- Etched Fine Black Graduations.
- Rules for every one.
- Pocket Rules are provided with clip for convenience as well as dual use as a depth gauge.

Item Code No.	Type	Graduation
ABM-EPT-7910	6" Pocket Rule	In inches 32nd 64ths
ABM-EPT-7911	6" Pocket Rule	In inches and m.m.
ABM-EPT-7912	6" Pocket Rule Diagonal Cut	In inches and m.m.
ABM-EPT-7913	6" Rule	In inches and m.m.
ABM-EPT-7914	12" Rule	In inches and m.m.
ABM-EPT-7915	18" Rule	In inches and m.m.
ABM-EPT-7916	24" Rule	In inches and m.m.
ABM-EPT-7917	36" Rule / 1 Meter	In inches and m.m.
ABM-EPT-7918	48"	In inches and m.m.
ABM-EPT-7919	1000 mm	In inches and m.m.
ABM-EPT-7920	1500 mm	In inches and m.m.
ABM-EPT-7921	2000 mm / 2 Meter	In inches and m.m.
ABM-EPT-7922	3000 mm / 3 Meter	In inches and m.m.

(i) Carbide Scraper - Magnetic Tip



- Can be used on hard surfaces.
- Long life, fixed points. 6" Long.
- Available in Steel body.
- With Magnetic Top Tip.

Item Code No.

ABM-EPT-8690

Description

Steel Body

(j) O Ring Hook & Scriber - 2 Pcs Set



Item Code No.

ABM-EPT-9980

- Knurled Center Tips.
- Hardened tips .
- Used for retrieving small parts, nuts & washers etc.
- O Ring & Steel pick For Easy removing & installing.

Adjustable Hook Rules

Stainless Steel



- Manufactured from high quality stainless Steel.
- Graduations are properly etched for accurate measurements.
- Packed in Attractive plastic pouch.

Item Code No.	Size	Style Code
ABM-EPT-9720	6"	4R
ABM-EPT-9721	12"	4R
ABM-EPT-9722	18"	4R
ABM-EPT-9723	24"	4R
ABM-EPT-9724	150 mm	Metric
ABM-EPT-9725	300 mm	Metric
ABM-EPT-9726	450 mm	Metric
ABM-EPT-9727	600 mm	Metric



Welding Taper Bore Gauge & Steel Ruler

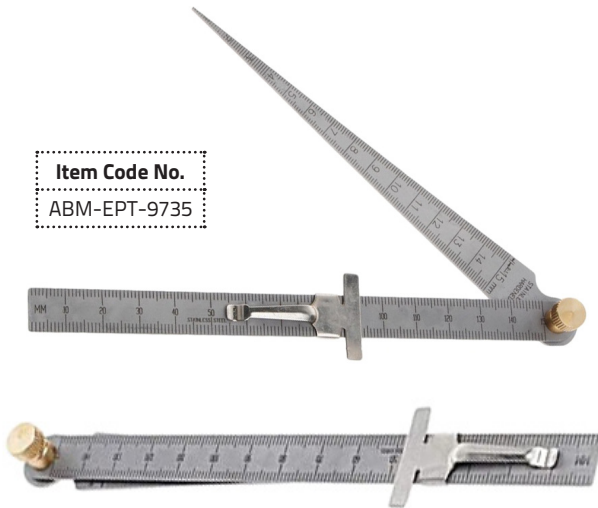

Item Code No.
ABM-EPT-9735

- It's a Combination of 1-15 mm Bore Gauge and Pocket Rule with clip MM & 0.5mm Locked with Adjustable Brass Screw.

Model Railroad Ruler



Item Code No.
ABM-EPT-9715

- Model railroader Ruler has scale graduations in HO, O, S and N Gauge with inch and millimeter calibrations.
- Also included a decimal equivalent chart and reference table on the opposite side.
- A versatile stainless steel Flexible Ruler for the model railroader. 1 inch wide x 12 inch long

Round Bar Centre Finder

- Accurately and quickly locates center on round workpiece.
- For execution place the tool in drill chuck or collet and line up pointer with line scribed on shaft.
- Supplied with instructions



Item Code No.	Shank Dia.		Overall Length	
	Inch	mm	Inch	mm
ABM-EPT-8760	1/4	6	3	75
ABM-EPT-8761	3/8	9.5	4-1/8	105

Drill Point Gauge

With Hook Ruler

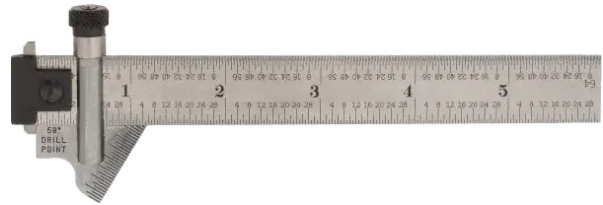

This gage was designed specifically for use in drill grinding. It provides a quick, accurate way for determining the correct drill point angle of 59° and the correct length of drill lips necessary for clean-cut drilling at maximum feeds and speeds.

The head is beveled to 59 degree (the correct drill point angle) It is also graduated in 1/32 along the 59 degree face for measuring the drill lips which should be of equal lengths
The hook rule has accurate, machine-divided graduations in 1/8, 1/16, quick-reading 1/32 and 64
Hook is adjustable and can be shortened or extended on either side of the rule, and may also be removed if desired
This gage was designed specifically for use in drill grinding, It provides a quick, accurate way for determining the correct drill point angle of 59 degree and the correct length of drill lips necessary for clean-cut drilling at maximum feeds and speeds
These rugged steel measures feature a satin chrome finish, sliding heads and adjustable and removable hook rules.

- For properly grinding 59° drill points and for measuring drill tips.
- Rule and slide are made of steel with satin chrome finish.
- Rigid rule is calibrated in 8ths, 16ths, 32nds and 64ths.
- End clip / Hook is adjustable and removable.
- Slide is calibrated in 32nds and 64ths.

Item Code No.	Size	
	Inch	mm
ABM-EPT-9745	6"	150 mm
ABM-EPT-9746	12"	300 mm

Wigglers Centre Finders



- ITEM CODE NO. ABM-EPT-8705**
- These sets are fast effective way of locating the Working centre on lathes, bench drills and milling machines.
- Hardened steel points and contacts ensure accurate location.
- The four attachments snap fit into the chuck without removing the collet nut and reducing down time. 5 pieces set imperial
- Chuck with 4 arms.
- Comes in attractive plastic pouch.
- Set consists of Snap in Holder, Needle Point Attachment, Ball Contact Attachment, Disc Contact Attachment and Off Set Indicator Holder.

Centre Square

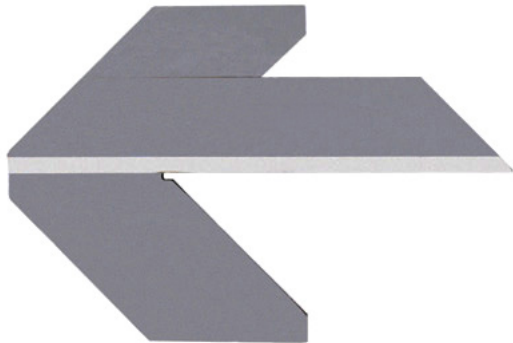

- Made From Tool Quality Steel.
- Blade Hardened And Tempered
- Designed For Fast And Accurate Location of The Centre of The Face of a Round Bar or Disc Within The Sizes Mentioned.
- Useful Square for Machinist's And Tool Makers.

Item Code No.	Work Diameter	
	Inch	mm
ABM-EPT-8540	1-1/2"	38
ABM-EPT-8541	3"	75
ABM-EPT-8542	Set of above two pcs.	

Electronic Edge Finder

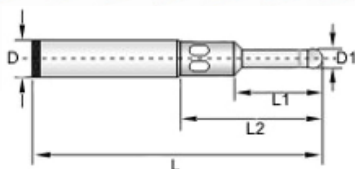

- This edge finder is very useful for centering the spindle above the workpiece for outside and inside centering as well as for counter boring on bores.
- It is also useful for measuring heights / depths.
- This can be used while the spindle is rotating or stationary.
- The sensor is highly sensitive and the red light is visible all round.
- The ball of the edge finder is suspended elastically and is pushed to the side when the reference edge is reached.
- Shank accuracy H7 and concentricity ± 0.005 mm.

Item Code No.	D	D1	L	L1	L2
ABM-EPT-8820	20	10	160	85	50

Engineers Bell Punch Center Finder



Item Code No.
ABM-EPT-8762

- Bell Punch Easily locates and allows center punching of ends on round stock of upto 35mm.
- Hardened to 48 – 52 HRC.
- Engineer's Bell Punch Hand DIY Center Finding Tool to Find Centre of Round Bar-Quickly, Easy & Accurate Engineering Machine Workshop Tools.
- A very Handy Precise Tool for Finding Center of a Round Bar upto 35 mm Diameter.
- Punch is made of EN31 Alloy Steel -Hard & Ground for Long Life Performance.
- It will center punch of a round bar upto 35 mm Diameter- Quickly, Easily and Accurately with out any significant Efforts.
- Its helpful when you want to drill any round piece and needs to find its center precisely.

Edge & Center Finder Set



- Edge & Center Finders are time saving positioning tools for use in Jig Boring, Milling Machines etc.
- Edge Finder Set Hardened Steel made of Tool Steel – Body and contacts both.
- Hardened, Ground and Lapped to close tolerances for diameter and concentrically.
- Cone Double End 1/2" x 3/16" Single End 3/8" x 3/16"
- Easily Helps to quickly locate working edges, shoulders, grooves, center points and scribe lines.
- Duly packed in Wooden Box Packing.

SET OF 5 Pcs.

Item Code No.
ABM-EPT-9523

Edge Finder / Centre Finders

- Hardened all over and ground on all working surfaces.
- Edge Finder Works Well on Round or Straight Surfaces.
- The centre finder will pick up cross lines to Machine Drill or Bore Holes to a layout.
- To Locate working edges like shoulders, centering points and scribed lines easily & accurately.
- Time saving positioning tool for Jig Borers and other machines.
- Available in inches and mm.
- Useful inspection tool for fast & efficient dimensional inspection on production parts.

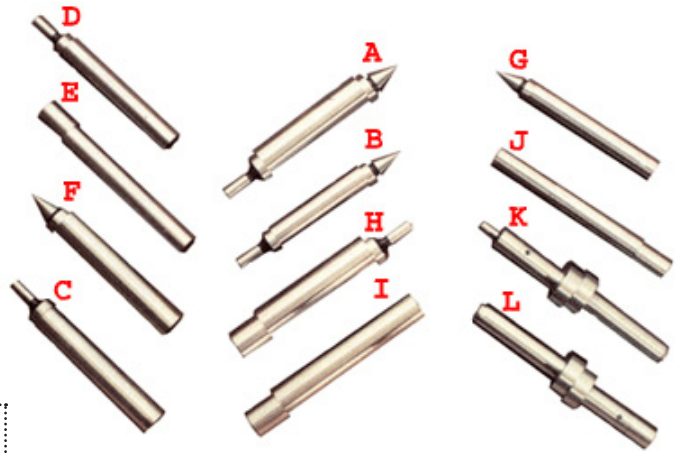

Imperial / Inch Item Code No.	Picture	Shank Dia.	Tip Dia.	Type
ABM-EPT-8765	A	1/2"	.2000"	Combination Edge & Centre Finder
ABM-EPT-8766	A	1/2"	.5000"	Combination Edge & Centre Finder
ABM-EPT-8767	B	3/8"	.2000"	Combination Edge & Centre Finder
ABM-EPT-8768	B	3/8"	.375"	Combination Edge & Centre Finder
ABM-EPT-8769	F	3/8	.375"	Center Finder Single End
ABM-EPT-8770	G	1/2"	.5000"	Center Finder Single End
ABM-EPT-8771	E	1/2"	.5000"	Plain Edge Finder Single End
ABM-EPT-8772	H	1/2"	.2000"	Edge Finder Double End
ABM-EPT-8773	C	3/8"	.2000"	Edge Finder Single End
ABM-EPT-8774	C	1/2"	.2000"	Edge Finder Single End
ABM-EPT-8775	E	0.500"	0.500"	Plain Edge Finder
ABM-EPT-8776	H	0.500"	0.200"	Double Edge Finder
ABM-EPT-8777	A	0.500"	0.200"	Combination Edge & Centre Finder
ABM-EPT-8778	B	0.375"	0.200"	Combination Edge & Centre Finder
ABM-EPT-8779	E	0.375"	0.200"	Edge Finder
ABM-EPT-8780	E	0.500"	0.200"	Edge Finder

Imperial / Inch Item Code No.	Picture	Shank Dia.	Tip Dia.	Type
ABM-EPT-8785	E	10 mm	10 mm	Plain Edge Finder Single End
ABM-EPT-8786	C	12 mm	5 mm	Edge Finder Single End
ABM-EPT-8787	A	10 mm	4 mm	Combination Edge & Centre Finder
ABM-EPT-8788	C	12 mm	4 mm	Edge Finder Single End
ABM-EPT-8789	H	12 mm	4 mm	Edge Finder Double End
ABM-EPT-8790	C	10 mm	4 mm	Edge Finder Single End
ABM-EPT-8791	E	12 mm	12 mm	Plain Edge Finder
ABM-EPT-8792	C	12 mm	4 mm	Edge Finder Single End
ABM-EPT-8793	A	12 mm	5 mm	Combination Edge & Centre Finder
ABM-EPT-8794	B	9 mm	5 mm	Combination Edge & Centre Finder
ABM-EPT-8795	D	9 mm	--	Edge Finder
ABM-EPT-8796	F	12 mm	--	Center Finder
ABM-EPT-8797	G	9 mm	--	Center Finder
ABM-EPT-8798	H	12 mm	5 mm	Double Edge Finder
ABM-EPT-8799	J	9 mm	--	Stepped Shank Edge Finder
ABM-EPT-8800	K	10 mm	4 mm	Edge Finder Metric Z Type Edge Finder
ABM-EPT-8801	L	10 mm	10 mm	Edge Finder Metric Z Type Edge Finder

Sine Bar Economy

- Body and rolls made of hardened Tool Steel.
- Precision Ground on all sides.
- Perfect tool for angular inspection and measurement.
- Moderately priced.

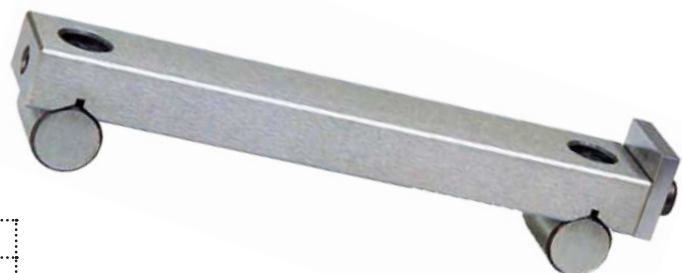

Item Code No.	Width	Distance Between Rolls
ABM-EPT-8330	1"	2-1/2"
ABM-EPT-8331	1"	5"

Measuring & Marking Tools



Sine Bar Precision



- Body and rolls made of hardened Tool Steel.
- Precision Ground on all sides.
- Perfect tool for angular inspection and measurement.
- Distance between center of rolls + .004".

Item Code No.	Model	Width	Distance Between Rolls
ABM-EPT-9960	AA	15/16"	5"
ABM-EPT-9961	AA	1"	10"
ABM-EPT-9962	BB	1"	2-1/2"
ABM-EPT-9963	BB	1"	5"
ABM-EPT-9964	CC	30 mm	100 mm
ABM-EPT-9965	CC	30 mm	100 mm
ABM-EPT-9966	DD	7/32"	3"

Wavy Parallels (Set of 8 Pcs.)



- Hardened
- Relieved spring steel.
- Height and parallelism.
- For the precise positioning of workpieces for milling, etc.
- Ideal for use with thin and fragile workpieces to avoid damage.
- Guaranteed to size in height and parallelism to +/- 0.002
- For supporting a work piece in a machine vice, to elevate the workpiece above the vice jaws.
- Supplied complete with wooden storage case.
- Set contains 8 Pcs in Pairs.

Item Code No.	Length mm	Height mm
ABM-EPT-9940	110	9, 11, 13, 15, 17, 19, 21 & 23
ABM-EPT-9941	110	25, 27, 29, 31, 33, 35, 37 & 39

V Sine Bar

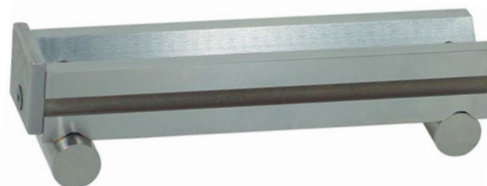

- Hardened & ground.
- Clamp included.
- Accurate to .0005"
- 1" round capacity

Item Code No.	Length	Width
ABM-EPT-9975	5"	1-1/4"

Working Block Pairs



Ultra Precision Working Block Pairs / Parallel Clamping Blocks

- Comes in various sizes and designs.
- The squareness and parallelism is controlled well within 2-3 microns / 0.0002".
- Hardened, Matched Pair, Precision Ground, Even Chamfering on all 6 sides.
- These matched pair can be bolted through any plain hole to the tapped hole to use as a Steps blocks, feelers, jigs, Angle plate, orientation and setting up tool.
- 23 holes consists of 5 tapped holes that are 5/8 -11 for clamping and 18 untapped holes
- Heat treated and case hardened to HRC 57-62
- Made of precision-grade tool steel hardened and ground on all 6 sides of block
- Cross drilling design allows for efficient use of lower weight with maximum strength
- Accurate installation work is possible.
- Used to set up, layout, and check jobs. Suitable for all kinds of machine tools.
- Scope of application: For clamping support, installation design and inspection work.

Item Code No.	Size of Block	No of Drill / Block
ABM-EPT-10060	1" x 2" x 3"	0
ABM-EPT-10061	1" x 2" x 3"	1
ABM-EPT-10062	1" x 2" x 3"	23 (5 Tapped Drills Included 3/8" x 16 TPI)
ABM-EPT-10063	2" x 4" x 6"	0
ABM-EPT-10064	2" x 4" x 6"	1
ABM-EPT-10065	2" x 4" x 6"	23 (5 Tapped Drills Included 3/8" x 16 TPI)

Steel Parallels

- Made from fine quality tool steel, hardened and ground.
- Packed in attractive wooden case.
- Made from EN-31, Hardness 50 to 58 HRC
- Accuracy 5 – 8 Micron (upto .008 mm)
- Very useful milling & drilling.
- Very useful in tool rooms for inspection, measuring, lathing off & setup jobs..
- Supplied in matched pairs

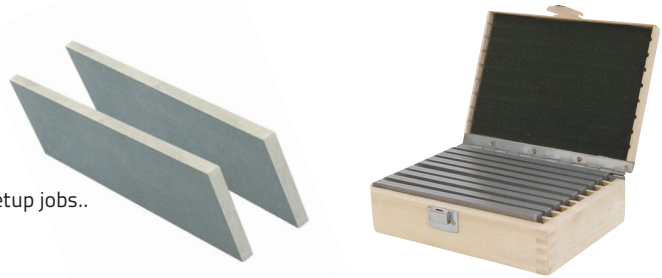

(a) Steel Parallels - Sets in Pairs (Packed in Wooden Box)

Item Code No.	Length mm	Thickness mm	Width of Each Pair							Quantity in each Sets
			1st	2nd	3rd	4th	5th	6th	7th	
ABM-EPT-8260	120	8	10	15	20	25	30	35	40	7 Pairs
ABM-EPT-8261	160	8	10	15	20	25	30	35	40	7 Pairs
ABM-EPT-8262	200	8	15	20	25	30	35	40	45	7 Pairs
ABM-EPT-8263	120	4	10	15	20	25	30	35	--	6 Pairs
ABM-EPT-8264	160	4	10	15	20	25	30	35	40	7 Pairs

(b) Steel Parallels - Pairs

Item Code No.	Length mm	Thickness mm	Width mm
ABM-EPT-8270	150	6	12
ABM-EPT-8271	150	6	19
ABM-EPT-8272	150	12	25
ABM-EPT-8273	100	5	10
ABM-EPT-8274	125	10	20
ABM-EPT-8275	150	15	30
ABM-EPT-8276	200	19	40
ABM-EPT-8277	250	25	50
ABM-EPT-8278	A Set of 3 Pairs containing on pair each of ABM-EPT-8270 to ABM-EPT-8272		

(c) Steel Parallels - Pairs

Item Code No.	Length mm	Height mm	Thickness mm	No of Pairs
ABM-EPT-8265	100	10-14-18-22-26-30-34-38-42	4	9
ABM-EPT-8266	160	10-14-18-22-26-30-34-38-42	4	9
ABM-EPT-8267	120	14-16-18-20-22-24-26-28-30-32-35-34-40	10	12
ABM-EPT-8268	150	14-16-18-20-22-24-26-28-30-32-35-34-40-45-50	10	14

Magnetic Chuck Parallels and Universal V Blocks

- Ground Steel used for highest magnetic transfer and is cast integrally with aluminium.
- Parallels are ground all over., V-Blocks are universal.

Item Code No.	Description	Size Inch
ABM-IMT-5570	One Pair Magnetic Chuck Parallel	1 x 2 x 4
ABM-IMT-5571	One Pair Magnetic Chuck V Block	1-7/8 x 2-3/8 x 2" Large V Capacity 2" Round Small V Capacity 1/2" Round
ABM-IMT-5572	One Magnetic Chuck Long V Block	1-7/8 x 2-3/8 x 4-3/8" Large V Capacity 2" Round Small V Capacity 1/2" Round
ABM-IMT-5573	One Pair Magnetic Chuck Long V Block	
ABM-IMT-5574	Combination Set of ABM-IMT-5570 & ABM-IMT-5571	

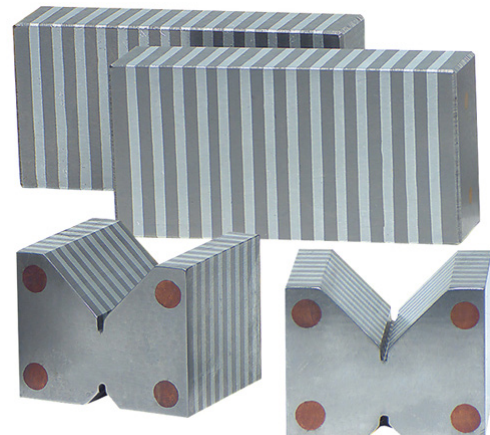

Engineer's Steel Parallels & Sets

- Made from fine quality tool steel, hardened and ground.
- Packed in attractive wooden case.
- Made from EN-31
- Hardness 50 to 58 HRC
- Accuracy 5 – 8 Micron (upto .008 mm)
- Very useful milling & drilling.
- Very useful in tool rooms for inspection, measuring, lathing off & setup jobs..
- Supplied in matched pairs

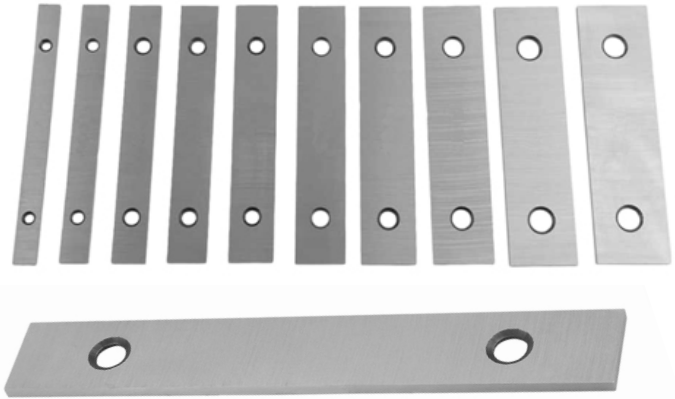

Item Code No.	Length Inch	Height Inch	Thickness Inch	No of Pairs
ABM-EPT-8280	6	2-1/2"	1/2, 5/8, 3/4, 7/8, 1, 1-1/8, 1-1/4, 1-3/8, 1-1/2 & 1-5/8	10
ABM-EPT-8281	3	3"	1/2, 5/8, 3/4, 7/8, 1, 1-1/8, 1-1/4, 1-3/8, 1-1/2 & 1-5/8	10
ABM-EPT-8282	6	3-1/2"	1/2 to 1-11/16, in 1/16 Steps	20
ABM-EPT-8283	1-1/2	5"	1/8, 5/32, 3/16, 7/32, 1/4, 9/32, 1/4, 9/32, 5/16, 11/32 & 3/8	9
ABM-EPT-8284	4	5-1/2"	1/2, 5/8, 3/4, 7/8, 1, 1-1/8, 1-1/4, 1-3/8, 1-1/2 & 1-5/8	10
ABM-EPT-8285	5	6"	1/2, 5/8, 3/4, 7/8, 1, 1-1/8, 1-1/4, 1-3/8, 1-1/2 & 1-5/8	10

Magnetic V Block Set

- Magnetic V Blocks required for Quality Control, Tool Room and Standard Room for variety of application in Tooling and Inspection purposes.
- Magnetic V-Block has a total 3 Magnetic surfaces.
- Top and bottom with 90° V-Angle and end surface opposite to switch.
- All working surfaces are precision ground.
- Ideal for holding, inspection and light machining.
- Suitable for holding Round or Irregular shaped for Scribing, Grinding etc., Grinding, Measuring and Machining.
- Accuracy of Vee is within 0.0003" (0.007 mm).
- A powerful, permanent magnet is controlled by Rotary ON / OFF Switch.
- Supplied in fine finished Wooden Box.
- Available in single and Dual Vee.



Item Code No.	Pcs.	Length		Width		Height	
		Inches	mm	Inches	mm	Inches	mm
ABM-IMT-5590	Single	2-3/16	55	1-3/4	45	1-15/16	50
ABM-IMT-5591	Single	2-3/4	70	2-1/8	73	2-7/8	73
ABM-IMT-5592	Single	4	100	2-3/4	70	3-3/4	95
ABM-IMT-5593	Pair	4	100	2-3/4	70	3-3/4	95
ABM-IMT-5594	Single	6	150	3	75	3-3/4	95
ABM-IMT-5595	Pair	6	150	3	75	3-3/4	95
ABM-IMT-5596	Single	8	200	6	150	4	100
ABM-IMT-5597	Pair	8	200	6	150	4	100



V Block Jig Fixture For Center Drilling of Round Work

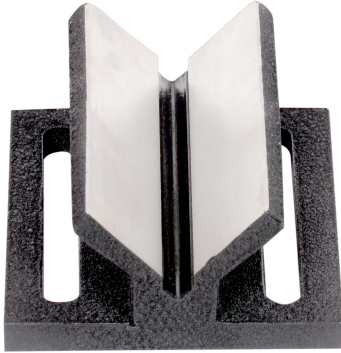

Item Code No.
ABM-EPT-10030

- It's a very important and useful accessory for you Drill Press & Mills.
- It makes drilling through the center of a Round bar or tubing so easy.
- It also works great when you need to hold a Round work-piece for sawing.
- Measures 5 Long x 4 Wide.
- The V-capacity is 2 (50 mm) maximum.
- The lengthwise T-slot width 10 mm gives the freedom of clamping it on any mill/ press easily.
- It is made of Graded Quality CI and much have higher strength than Aluminium version of it.
- Also our supply will have a Precise grounded V and base. The rest of the body shall be black painted

Elongated Vee Blocks

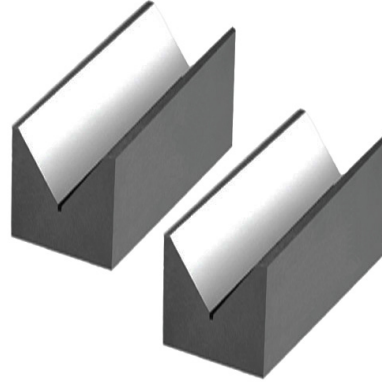

- All Side precision ground parallel and square.
- 'V' Grooves ground central & Parallel and square.
- Perfect alignment in matched pair.
- Holds the square and round work perfectly.

Item Code No.	Length x Width x Height mm	V Capacity mm
ABM-EPT-9870	75 x 40 x 30	5 - 40
ABM-EPT-9871	100 x 47 x 40	5 - 55
ABM-EPT-9872	150 x 55 x 45	5 - 60
ABM-EPT-9873	200 x 65 x 55	5 - 75

Vee Blocks - Non Protruding



- Supplied in Matched pairs.
- Made from High Quality steel, hardened throughout upto 55-60 HRC.
- Accurately machined & precision ground to extreme accuracy.
- Each block is aligned with 90 Degree 'V'.
- Sturdy type clamp allows the block to be used on the side face including to the base.
- Provided with two-black oxidized clamp.

Item Code No.	Length x Width x Height	Clamping Capacity
ABM-EPT-9860	2-3/4" x 2-1/2" x 1-3/4" (70 x 63 x 45 mm)	1-1/2" (38 mm)
ABM-EPT-9861	4-7/8" x 3-1/2" x 2-3/4" (125 x 88 x 70 mm)	2-1/8" (54 mm)

Triple Vee Blocks



- Manufactured from steel.
- Every angle 90 Degree.
- Matched Pairs.

Item Code No.	Length mm	Width mm	Height mm	Suitable for Dia.
ABM-EPT-9880	50	20	14	5 - 33
ABM-EPT-9881	75	24	35	6 - 45
ABM-EPT-9882	100	33	52	8 - 60
ABM-EPT-9883	125	44	69	8 - 75

Machinist V-Block Set (Tool Maker's)



- All sides are ground square and parallel to each other.
- V's are central, parallel and square and are matched in pairs.
- Made of properly heat treated and hardened tool steel.
- Precision made from machinist's and tool-maker use.
- Designed for Machine Shop.
- Set Consists of Two V-Blocks and Two Clamps.
- Geometrical Accuracy as per BS 3731 / DIN 2274 Grade2.
- Permissible height difference for matched pair within .0003" or 8 microns.
- Parallelism tolerance of Vee axis to base within .0004" or (10+L/50) microns.
- Perpendicularity tolerance of end and side faces to base within .0005" or (10+H/25) microns.

Item Code No.	Length x Width x Height		Clamping Capacity	
	Inch	MM	Inch	mm
ABM-EPT-8440	1-5/8 x 1-1/4 x 1-1/4	40 x 32 x 32	1	25
ABM-EPT-8441	1-3/4 x 1-5/8 x 1-7/16	45 x 40 x 36	1	25
ABM-EPT-8442	2 x 1-1/2 x 1-1/2	50 x 37 x 37	1-1/2	38
ABM-EPT-8443	2-3/8 x 1-5/8 x 2	60 x 40 x 50	1-1/2	38
ABM-EPT-8444	2-3/4 x 1-3/4 x 1-5/8	70 x 45 x 40	2	50
ABM-EPT-8445	3 x 2-3/16 x 2-3/16	75 x 55 x 55	2	50
ABM-EPT-8446	3-3/16 x 2-5/8 x 2-5/8	80 x 65 x 65	2-1/2	63
ABM-EPT-8447	4 x 3 x 3	100 x 75 x 75	2-3/4	70
ABM-EPT-8448	5 x 3-1/2 x 2-3/4	100 x 90 x 70	1-7/8	45

V - Block (Casted)

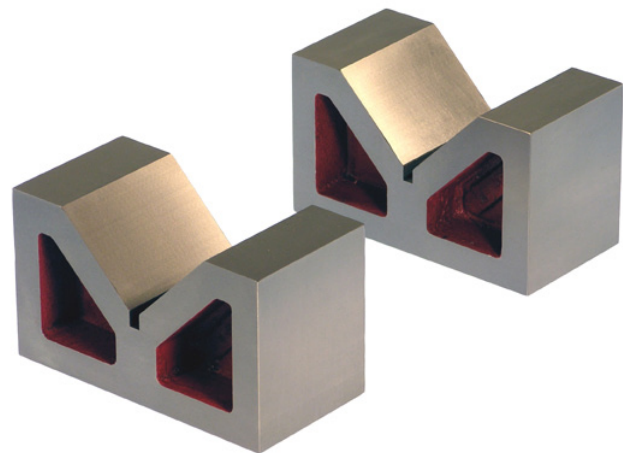

- Supplied in Machined and Numbered pairs.
- Made of High Quality Seasoned Castings.
- Blocks are accurately Machined Square and Parallel.

Item Code No.	Length		Height		Thickness of Each Block		Width of VEE	
	Inches	mm	Inches	mm	Inches	mm	Inches	mm
ABM-EPT-8350	2	50	1-1/4	32	1	25	1	25
ABM-EPT-8351	3	75	2-3/8	60	1-1/4	32	1-3/4	45
ABM-EPT-8352	4	100	2-5/8	65	1-5/8	40	2	50
ABM-EPT-8353	5	125	3-1/8	80	2	50	2	50
ABM-EPT-8354	6	150	3-1/2	90	2-1/2	63	3-1/4	82
ABM-EPT-8355	7	175	4-1/2	115	3	75	3-1/2	90
ABM-EPT-8356	8	200	5-1/2	140	4	125	4	100
ABM-EPT-8357	10	250	6-5/8	168	5	125	5	125
ABM-EPT-8358	12	300	8	200	7	180	6-1/2	165

Precision V-Block & Clamp Set (Multi Side Use) Vee Block Stepped Groove

- Multi-Use : Holds both Square and Round Work.
- Stepped Groove Construction permits both Low and High Clamping.
- Side Hole-Provided in each block to facilitate clamping.
- Made of Hardened Tool Steel, Machined and Ground in Pairs.
- All Sides Precision Ground Parallel and Square to an accuracy of 0.0003".
- Set Consists of Two V-Blocks and Two Clamps.
- Capacity : 2" (50 mm) Round and 1-7/16" (36.5 mm) Square.

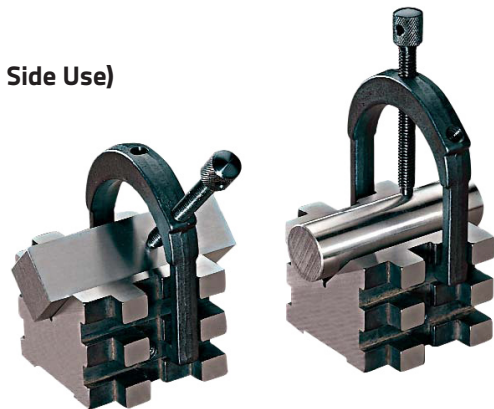

Item Code No.	Length		Width		Height	
	Inch	mm	Inch	mm	Inch	mm
ABM-EPT-8460	2-3/8	60	2-3/4	70	2	50

Precision V-Block & Clamp (Ultimate) (All Angle)

- Ultimate V-Block for Grinding, Milling or Drilling work.
- Made of hardened and Precision ground tool steel.
- The sides are parallel and VEE is central and ground.
- Central Hole is provided for Drilling or removing Pins.
- Clamp is smaller than outside width of the V-Block and has adjustable side screw for support.
- V-Block has four 3-8/16" tapped holes two in the base and one on each side for angle Iron clamping.
- Block is provided with black oxidized clamp.
- Holding Capacity 1-5/16" (33 mm).
- Vee Blocks are capable of being used on base, on end and flat in either sides as the clamp is within the outside width of the Block.

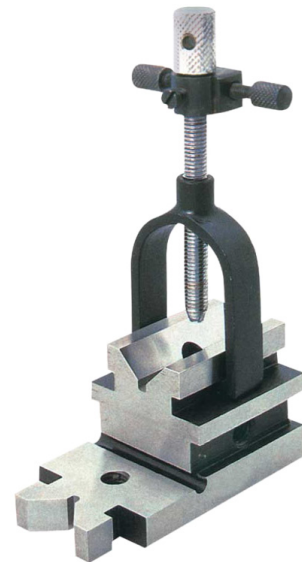

Single Clamp Item Code No.	Pair Clamps Item Code No.	Length		Width		Height	
		Inch	mm	Inch	mm	Inch	mm
ABM-EPT-8465	ABM-EPT-8470	3-5/8	92	1-7/8	48	1-7/8	48

Precision Adjustable Angle Block Sets

- Ideal for Fast Angle Positioning for layout, drilling, grinding and milling setup tasks where a surface face to a particular angle is required.
- Has a 0 - 60° adjustable angle which can be used by locking hex screw on bottom.
- 1 graduation and ± 10 minute angle accuracy.
- Squarness : 0.0004" (0.01 mm). Hardened to 50 - 55 HRC.

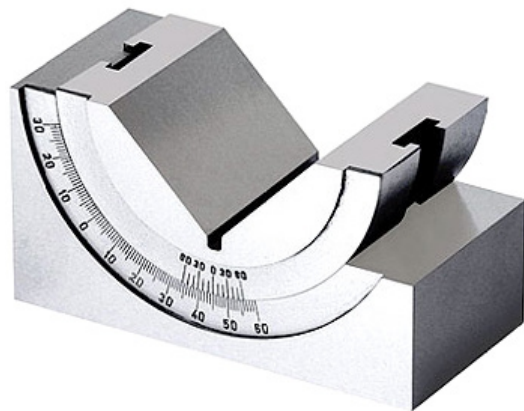

Item Code No.	Overall Length		Overall Width		Overall Height		V Capacity	
	Inch	mm	Inch	mm	Inch	mm	Inch	mm
ABM-EPT-8490	3	75	1-11/32	34	1	25	1-5/32	29.5
ABM-EPT-8491	3-3/4	95	2	50	1-3/16	30	1-29/32	48.5
ABM-EPT-8492	3-3/4	95	2	50	1-3/4	45	1-29/32	48.5

V - Block Quadruple

Four Way Vee Blocks

- Made from seasoned closed grained cast Iron.
- Universal V-Block consisting of Four different size grooves.
- Supplied in Pairs.
- Very useful tool for laying out round work & holding it for machining.
- Each block incorporates 4 different sized V's, therefore support wide range of jobs.



Item Code No.	Length		Height		Thickness		Width of VEE	
	Inches	mm	Inches	mm	Inches	mm	Inches	mm
ABM-EPT-8370	3-3/4	95	2-3/4	70	1-3/8	35	3/4 x 1-3/16 x 1-9/16 x 2	20 x 30 x 40 x 50
ABM-EPT-8371	4	100	4	100	1-3/16	30	3/4 x 1-3/16 x 1-9/16 x 2	20 x 30 x 40 x 50
ABM-EPT-8372	4-3/4	120	4-3/4	120	1-3/8	35	1-3/16 x 1-9/16 x 2 x 2-3/8	30 x 40 x 50 x 60
ABM-EPT-8373	4-3/4	120	4-3/4	120	2-3/8	60	1-3/16 x 1-9/16 x 2 x 2-3/8	30 x 40 x 50 x 60
ABM-EPT-8374	6	150	6	150	3	75	1-9/16 x 2 x 2-3/8 x 2-3/4	40 x 50 x 60 x 70
ABM-EPT-8375	8	200	8	200	4	100	2-3/8 x 2-3/4 x 3-5/3 x 4	60 x 70 x 80 x 100

Ultra Precision Vee Block

Versatile Vee Block With Clamps

- This Vee block is having a very large capacity which is ideal for toolroom production and inspection jobs.
- Made of hardened steel, they are precision ground flat, square and parallel to within .002" over 1".
- It can be used on its sides as well as on the ends.
- The clamp does not interface with the work when the block is used sideways.
- The style of the clamp is such that it can be reversed to provide true tangential contact on cylindrical work.
- Tapped holes on the end of the Vee are useful for mounting the Vee Blocks perpendicular to the face plates.
- They are also available as matched pairs, with 2 clamps.

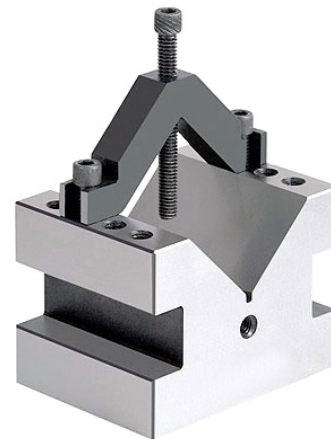

Item Code No.	Type	Overall Length		Overall Width		Overall Height		Clamping Capacity	
		Inch	mm	Inch	mm	Inch	mm	Inch	mm
ABM-EPT-8390	Single Piece	2-1/2	63	2-1/2	63	2	50	1-5/8	41
ABM-EPT-8391	Pair	2-1/2	63	2-1/2	63	2	50	1-5/8	41
ABM-EPT-8392	Single Piece	4	100	3	75	3	75	2-1/4	57
ABM-EPT-8393	Pair	4	100	3	75	3	75	2-1/4	57

Box Type Angle Plate

- Manufactured from close grained cast iron.
- Machined & ground square & parallel on all faces.
- Tee slots are machined from solid casting.

Item Code No.	Size	
	Inch	mm
ABM-EPT-10000	3" x 2-1/2" x 2"	75 x 63 x 50
ABM-EPT-10001	4" x 3-3/8" x 2-3/4"	100 x 85 x 60
ABM-EPT-10002	5" x 4-1/2" x 3-3/8"	125 x 113 x 85

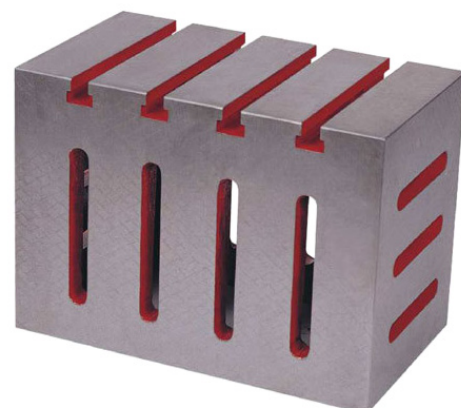



Vee Angle Blocks & Angle Plate Combined

V ANGLE PLATE / VEE BLOCK Combined V Block & Angle Plate

- As the name rightly suggests it has dual usage as a vee block and an angle plate.
- Having a single piece close grained cast iron construction, which ensures rigidity.
- Casting are stress relieved.
- Useful for easy operations in set up jobs.
- The angle block is precision ground and has a parallelism of $\pm 0.005"$ (0.012 mm) and a squareness of $\pm 0.005"$ (0.012 mm).
- Available in Vee Angle Plate-Tee Slotted and Vee Angle Plate – Slotted



Item Code No. Slotted	Item Code No. Tee Slotted	Size	
		Inch	mm
ABM-EPT-8824	ABM-EPT-8830	3" x 3" x 5"	75 x 75 x 125
ABM-EPT-8825	ABM-EPT-8831	4" x 4" x 6"	100 x 100 x 150
ABM-EPT-8826	ABM-EPT-8832	5" x 5" x 7"	125 x 125 x 175
ABM-EPT-8827	ABM-EPT-8833	6" x 6" x 8"	150 x 150 x 200

Modular Machine Vice Cum Slotted Table

- Multi purpose 2 way axis Interchangeable machine modular vice cum slotted table.
- Robust construction manufactured from closed grain high tensile seasoned cast iron.
- Used for milling, shaping, drilling, grinding etc.
- This vice can be replaced by t-slot table provided in the set.
- Tilting movement 0-45°
- Horizontal movement 0-90°
- Fixed rotary base provide with 360° rotation.
- Jaws are hardened and ground.

Contains : Set of 3 pcs.
Vice – 1 Unit
Revolving Base – 1 Unit
Tee Slotted Table – 1 Unit



Item Code No.	Vice Jaw Width		Vice Jaw Opening		Vice Jaw Depth		Table Size	
	Inch	mm	Inch	mm	Inch	mm	Inch	mm
ABM-EPT-11610	2"	50	2"	50	1"	25	5" x 4" x 7/8"	125 x 100 x 22
ABM-EPT-11611	3"	75	3"	75	1-1/4"	32	8" x 6" x 1-1/4"	200 x 150 x 28
ABM-EPT-11612	4"	100	4"	100	1-1/2"	38	10" x 8" x 1-9/16"	250 x 200 x 40

Small Angle Plate

For Myford Lathes



Item Code No.
ABM-EPT-10020

- Manufactured from close grain caste Iron & Precision ground.
- Size : 60 mm x 50 mm x 100 mm
- 2 Base Tee slots 10.5 mm wide x 30 mm long
- This size is very useful when face when plate is required or on small milling machines.

Slim Angle Plate



Item Code No.
ABM-EPT-10010

- Myford Lathe Style Slim Angle Plate for using onto a face plate.
- Dimensions: 58mm x 58mm x 150mm long
- 5 Slots of 35 mm Length x 10 mm Width.

Stepped Angle Plate

- Made from EN-31 Steel.
- Hardened and ground.
- Tapped holes for clamping jobs in any position.
- Stepped construction.
- Flatness and squareness to within 0.002" per 6"

Item Code No.	Size	
	Inch	mm
ABM-EPT-8850	3 x 3 x 3	75 x 75 x 75
ABM-EPT-8851	4 x 4 x 4	100 x 100 x 100

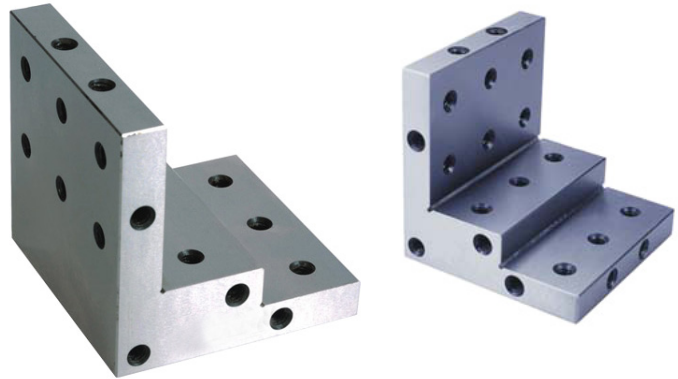

Swivel Angle Plates / Table

- Heavy duty Cast Iron
- Graduated 0 – 90° Range.
- Precision Ground Table Surface.
- Machined T-Slots.
- 2 Screw locks provided for setting purposes.
- The swiveling face in the swivel angle plates is provided with T-slots machined from solid. Other face is provided with as cast cored slots for clamping the angle plate on machine table.

Item Code No.	Table Size		Approx Height mm
	Inch	mm	
ABM-VC-11500	5 x 6	125 x 150	110
ABM-VC-11501	6 x 8	150 x 200	130
ABM-VC-11502	8 x 10	200 x 250	165
ABM-VC-11503	10 x 12	250 x 300	210
ABM-VC-11504	12 x 15	300 x 375	230

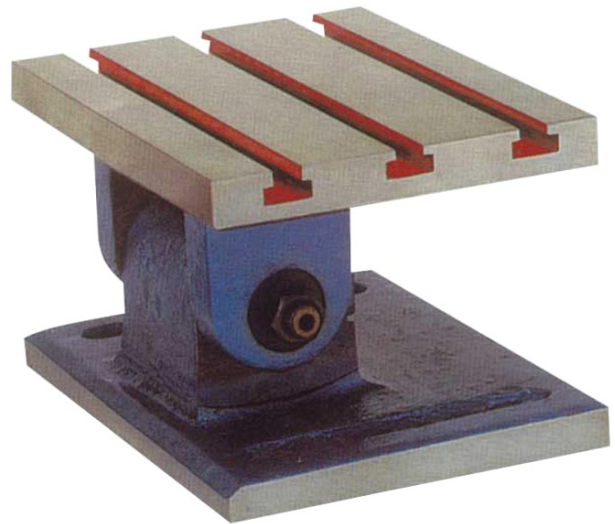

Universal Tilting Tables (Adjustable Angle Plate) (Precision)

- Heavy and sturdy Machined construction.
- Range 45 Degree each way from Vertical.
- Locking action by 2 clamping screws on each end.
- 3 Machined 'T' slots and precise ground Table Surface.
- Swivel Base Model
- Swivel Graduation 360 Degree.

Item Code No.	Table Size	
	Inch	mm
ABM-VC-11510	4 x 5	100 x 125
ABM-VC-11511	6 x 8	150 x 200
ABM-VC-11512	8 x 10	200 x 250

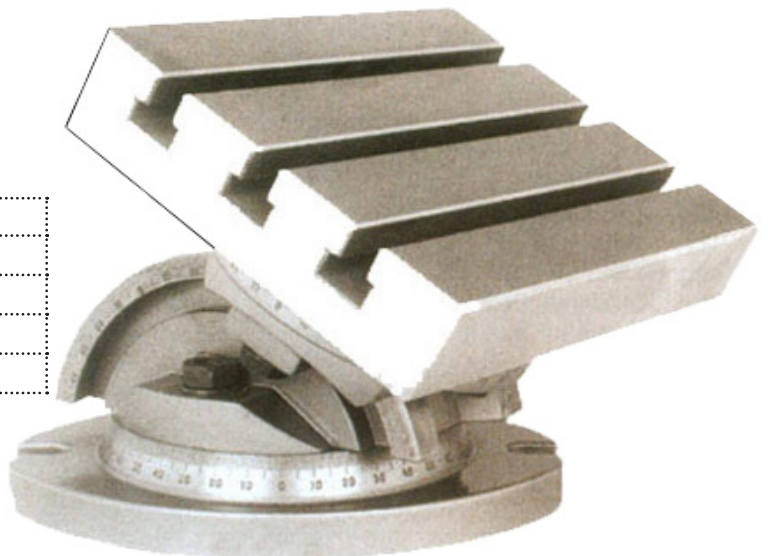
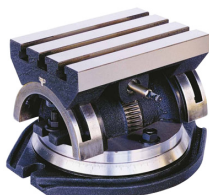



Slotted Machine Angle Plate (Webbed and Open)



- Made of High quality Seasoned castings.
- Precision Ground sides & Ends.
- Accurately machines 90° Degree Square.
- Available both in Open End and Webbed End Styles.

Webbed End Item Code No.	Open End Item Code No.	Length	Width (First Angle)	Height (Second Angle)
ABM-EPT-8880	--	3"	2-1/2"	2"
ABM-EPT-8881	--	3-1/2"	3"	2-1/2"
ABM-EPT-8882	ABM-EPT-8891	4-1/2"	3-1/2"	3"
ABM-EPT-8883	ABM-EPT-8892	6"	5"	4-1/2"
ABM-EPT-8884	ABM-EPT-8893	7"	5-1/2"	4-1/2"
ABM-EPT-8885	ABM-EPT-8894	8"	6"	5"
ABM-EPT-8886	ABM-EPT-8895	9"	7"	6"
ABM-EPT-8887	ABM-EPT-8896	10"	8"	6"
ABM-EPT-8888	ABM-EPT-8897	12"	9"	8"
ABM-EPT-8889	--	16"	12"	9"
ABM-EPT-8890	--	20"	16"	12"

Solid Angle Plate



- Made from High quality Casting.
- Castings are properly seasoned to avoid distortion.
- Precision ground sides and Ends.
- As Per BS5535 Grade B.
- Flatness and Squareness within .002" Per 6" for Machined finish and .001" per 6" for Ground finish.

Machined Finish Item Code No.	Precision Ground Finish Item Code No.	No of Ribs	Size	
			Inches	mm
ABM-EPT-8950	ABM-EPT-8959	0	1 x 1 x 1	25 x 25 x 25
ABM-EPT-8951	ABM-EPT-8960	1	2 x 2 x 2	50 x 50 x 50
ABM-EPT-8952	ABM-EPT-8961	1	3 x 3 x 3	75 x 75 x 75
ABM-EPT-8953	ABM-EPT-8962	1	4 x 4 x 4	100 x 100 x 100
ABM-EPT-8954	ABM-EPT-8963	1	5 x 5 x 5	125 x 125 x 125
ABM-EPT-8955	ABM-EPT-8964	1	6 x 6 x 6	150 x 150 x 150
ABM-EPT-8956	ABM-EPT-8965	2	8 x 8 x 8	200 x 200 x 200
ABM-EPT-8957	ABM-EPT-8966	2	10 x 10 x 10	250 x 250 x 250
ABM-EPT-8958	ABM-EPT-8967	2	12 x 12 x 12	300 x 300 x 300

Right Angle Iron Plate

- Used for fixture component and checking Square ness and Parallelism.
- Side ends and faces are finished Square and Parallel within .002" per 6".

Item Code No.	Dimension (Length x Width x Height)	
	Inch	mm
ABM-EPT-8869	3-3/4 x 4 x 5	95 x 100 x 125
ABM-EPT-8870	4 x 4 x 6	100 x 100 x 150
ABM-EPT-8871	4-1/2 x 5 x 6	114 x 125 x 150
ABM-EPT-8872	4-1/2 x 5 x 8	114 x 125 x 200
ABM-EPT-8873	5 x 8 x 12	125 x 200 x 300
ABM-EPT-8874	5-1/2 x 7 x 10	139 x 175 x 250
ABM-EPT-8875	5-1/2 x 8 x 10	139 x 200 x 250
ABM-EPT-8876	6 x 6 x 8	150 x 150 x 200
ABM-EPT-8877	8 x 10 x 12	200 x 250 x 300
ABM-EPT-8878	8 x 9 x 16	200 x 225 x 400
ABM-EPT-8879	12 x 12 x 24	300 x 300 x 600

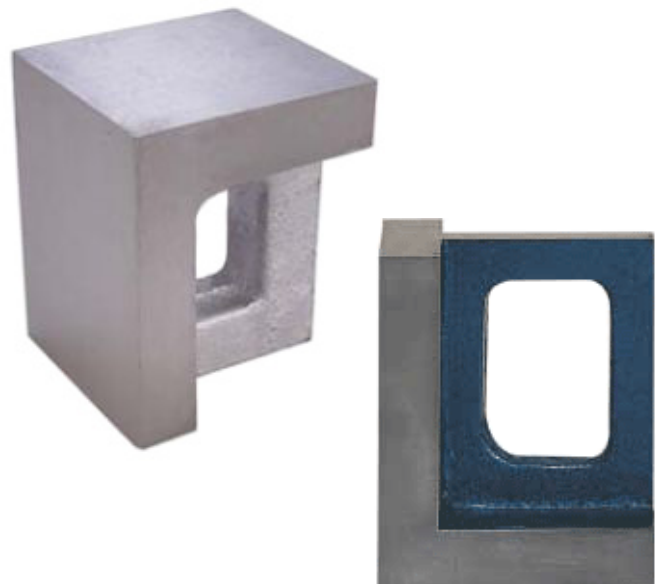

Tilting Tables (Adjustable Angle Plate)

- Heavy and sturdy Machined construction.
- Range 45 Degree each way from Vertical.
- Locking action by 2 clamping screws on each end.
- 3 Machined 'T' slots and precise ground Table Surface.
- Low profile for low machine head clearance.
- Also available with swivel Base

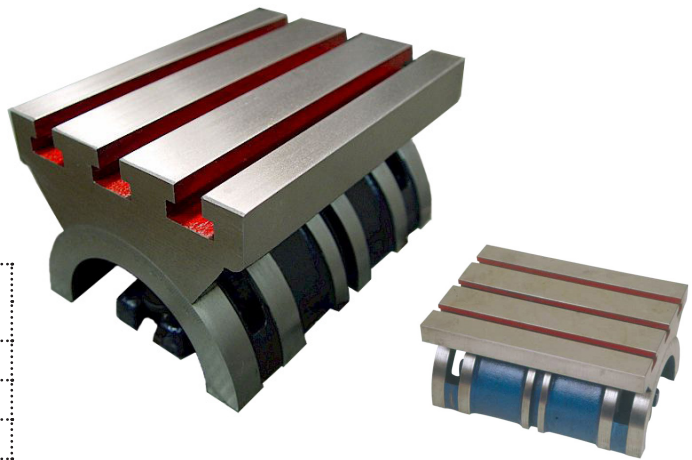

Item Code No.	Table Size		Approx. Height
	Inch	mm	
ABM-VC-11480	5 x 7	125 x 175	95
ABM-VC-11481	7 x 10	175 x 250	125
ABM-VC-11482	10 x 15	250 x 375	170

Surface Plate (Cast Iron & Graphite)

Round / Square / Rectangular

(A.) Cast Iron

- Made from High Quality close grained cast iron. Stress relieved against distortion. Precisely finished by planning and hand scraping.

(B.) Granite

- Made out of selected black granite having uniform texture and colour. Very dense and hard wearing. Non-Magnetic non glaring, economical, lesser wear, no oiling, no rust.

Square / Rectangular

Item Code No. Cast Iron	Item Code No. Granite	Size Width x Length	
		Inch	mm
ABM-EPT-8910	ABM-EPT-8918	12 x 12	300 x 300
ABM-EPT-8911	ABM-EPT-8919	16 x 16	400 x 400
ABM-EPT-8912	ABM-EPT-8920	16 x 24	400 x 600
ABM-EPT-8913	ABM-EPT-8921	24 x 24	600 x 600
ABM-EPT-8914	ABM-EPT-8922	24 x 40	600 x 1000
ABM-EPT-8915	ABM-EPT-8923	40 x 40	1000 x 1000
ABM-EPT-8916	ABM-EPT-8924	40 x 64	1000 x 1600
ABM-EPT-8917	ABM-EPT-8925	40 x 80	1000 x 2000

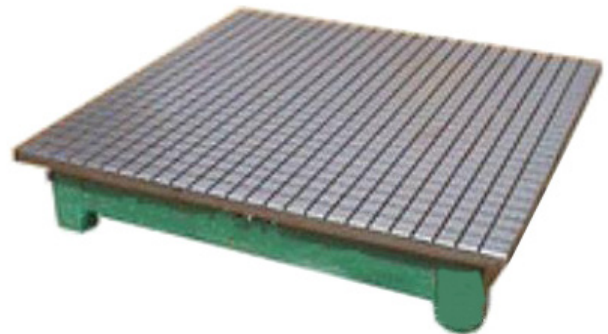

Round

Item Code No. Round	Diameter x Thickness mm
ABM-EPT-9920	50 x 30
ABM-EPT-9921	75 x 30
ABM-EPT-9922	100 x 30
ABM-EPT-9923	125 x 30
ABM-EPT-9924	150 x 40
ABM-EPT-9925	200 x 40
ABM-EPT-9926	250 x 50
ABM-EPT-9927	300 x 60

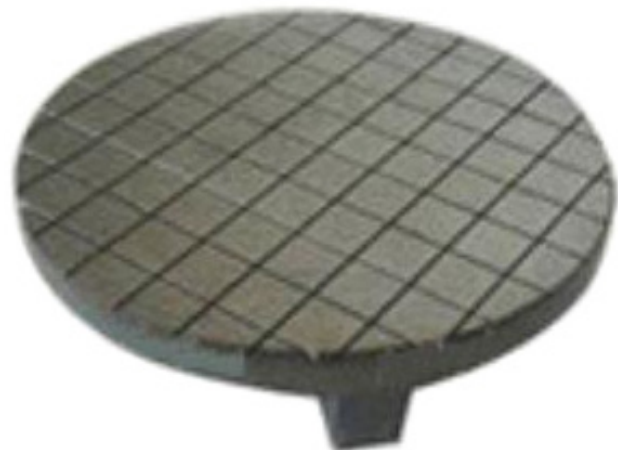

Surface Plate Box Type Cast Iron

- Manufactured from Superior Quality Seasoned Cast Iron.
- Top Surface is Thick & Solid.
- Used for Checking Parallelism & Angles and also to mount up optical systems in workshops.
- Stands also available for corresponding sizes.
- Custom Made Sizes can also be manufactured as per request.

Item Code No.	Length		Width	
	Inch	mm	Inch	mm
ABM-EPT-9900	12	300	8	200
ABM-EPT-9901	12	300	12	300
ABM-EPT-9902	18	450	12	300
ABM-EPT-9903	18	450	18	450
ABM-EPT-9904	24	600	18	450
ABM-EPT-9905	24	600	24	600
ABM-EPT-9906	36	900	24	600
ABM-EPT-9907	30	750	30	750
ABM-EPT-9908	36	900	36	900
ABM-EPT-9909	48	1200	36	900

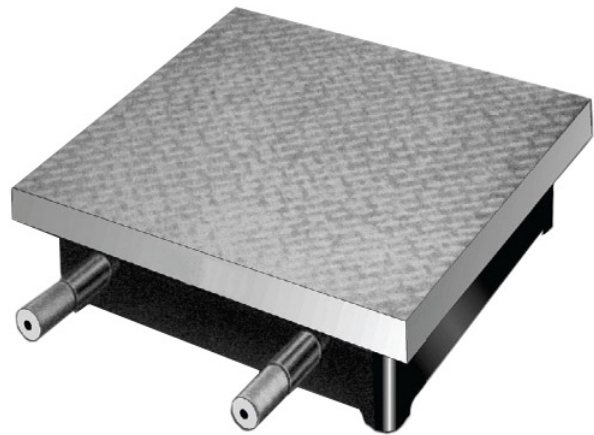

Engineer's Precision Sets (6 Pcs.)

- A must in every workshop.
- Duly packed in Wooden Box Packing.

Item Code No.
ABM-EPT-9525

SET CONTAINS (Set of 6 Pcs.)

- Angular Depth Gauge 6" / 150 mm
- Vernier Calliper 5" / 125 mm
- Divider – Spring Calliper – Black Powder Coated – 6" / 150 mm
- Inside – Spring Calliper – Black Powder Coated – 6" / 150 mm
- Outside – Spring Calliper – Black Powder Coated – 6" / 150 mm
- Pocket Rule – Stainless Steel – 6" / 150 mm



Engineer's Tool Kit (11 Pcs.)

- Very useful for measuring.
- A must in every workshop.
- Duly packed in Wooden Box Packing.

SET CONTAINS (Set of 11 Pcs.)

- Pocket Scriber.
- Bore Gauge 1 mm – 16 mm.
- Precision Steel Square 6".
- Universal Gauge.
- Protractor cum Depth Gauge.
- Automatic Center Punch.
- Screw Cutting Gauge.
- Spring Calliper Divider 4".
- Thread Pitch Gauge – Combined.
- Brass Verner 4".
- Steel Rule 6".

Item Code No.
ABM-EPT-9515



Precision Tools Set (11 Pcs.)

- A must in every workshop.
- Duly packed in Wooden Box Packing.

SET CONTAINS (Set of 11 Pcs.)

- Steel Rule 6"
- Pocket Rule 6"
- Automatic Center Punch
- Center Square 1-1/2" / 38 mm
- Carbide Scriber
- Tap Guide – Spring Loaded – Knurled Body
- Tap Guide – Spring Center
- Center Square 3" / 75 mm
- Multipurpose Angle Protractor
- Depth Gauge Engineer's 6"
- Round Bar Center Finder

Item Code No.

ABM-EPT-9519

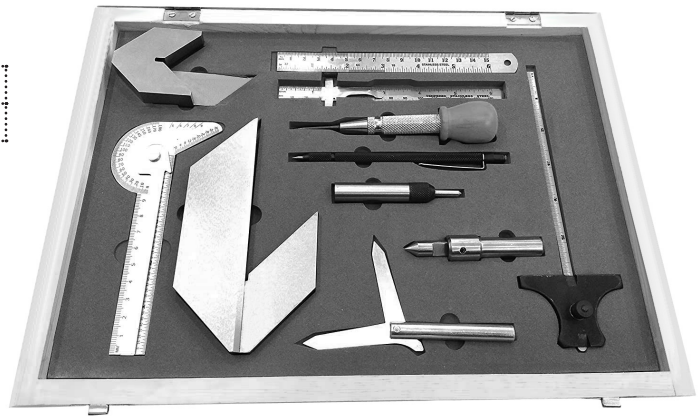

Precision Steel Squares Sets (4 Pcs.)

- Very useful for setting up equipment.
- A must in every workshop.
- Duly packed in Wooden Box Packing.

SET CONTAINS (Set of 4 Pcs.)

- Precision Steel Square 2".
- Precision Steel Square 3".
- Precision Steel Square 4".
- Precision Steel Square 6".

Item Code No.

ABM-EPT-9518



Edge & Center Finder Set (5 Pcs.)

- Edge & Center Finders are time saving positioning tools for use in Jig Boring, Milling Machines etc.
- Edge Finder Set Hardened Steel made of Tool Steel – Body and contacts both.
- Hardened, Ground and Lapped to close tolerances for diameter and concentricity.
- Cone Double End 1/2" x 3/16" Single End 3/8" x 3/16"
- Easily Helps to quickly locate working edges, shoulders, grooves, center points and scribe lines.
- Duly packed in Wooden Box Packing.

SET OF 5 Pcs.

Item Code No.

ABM-EPT-9523



Center Square & Precision Square Kit (6 Pcs.)

- Very useful for setting up equipment.
- A must in every workshop.
- Duly packed in Wooden Box Packing.

SET CONTAINS (Set of 6 Pcs.)

- Pocket Scriber.
- Centre Square 1-1/2".
- Automatic Center Punch.
- Precision Steel Square 2".
- Precision Steel Square 4".
- Precision Steel Square 6".

Item Code No.

ABM-EPT-9513



Center Square & Precision Square Kit (6 Pcs.)

- Very useful for setting up equipment.
- A must in every workshop.
- Duly packed in Wooden Box Packing.

SET CONTAINS (Set of 6 Pcs.)

- Pocket Scriber
- Centre Square 1-1/2"
- Stainless Steel Rule 6"
- Precision Steel Square 2"
- Precision Steel Square 4"
- Precision Steel Square 6"

Item Code No.

ABM-EPT-9510



Protractor (Degree Protractors)



- Made From Stainless Steel.
- Measures Angles from 0° to 180°
- Available in Round and Rectangular.
- Used to draw radila lines, setting bevels and transferring angles.
- Rectangular head protractor provides four convenient working edges.

Item Code No.	Size
ABM-EPT-9460	6"
ABM-EPT-9461	8"
ABM-EPT-9462	12"

While Placing Order Please Mention
1. With or Without Scale Etched
2. Round Head or Rectangular Haad

Twist Drill Grinding Gauge

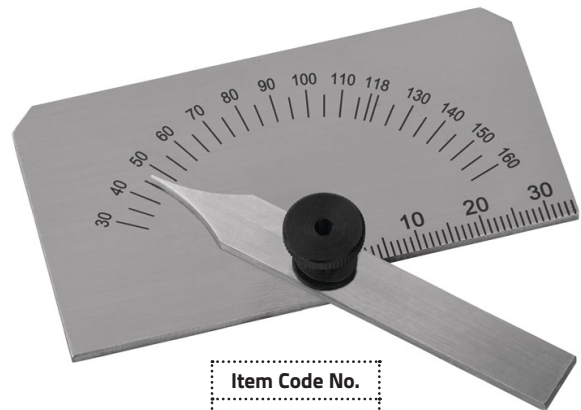

Item Code No.
ABM-EPT-9740

- Measuring angle of drills up to Dia. 60mm.
- With Adjustable Pointer.
- Made of Stainless steel.
- With adjustable angle from 30° to 160°
- Finish: Glossy Shiny Finish or Matt Finish (Non Shiny-Vernier Type).

Protractor Cum Depth Gauge

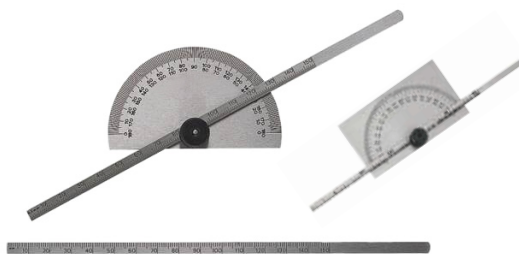

- **ITEM CODE NO. ABM-EPT-9470**
- Made of Steel.
- Measure Angles from 0° to 180°
- Combination of Protractor and Depth Gauge.
- Spring Tension Nut to secure rule to desired depth and angle.
- Narrow 6" (150 mm) rule graduated 64th on one side and 0.5 mm at reverse.
- Available in Round and Rectangular.
- While placing order please mention Round or Rectangular.

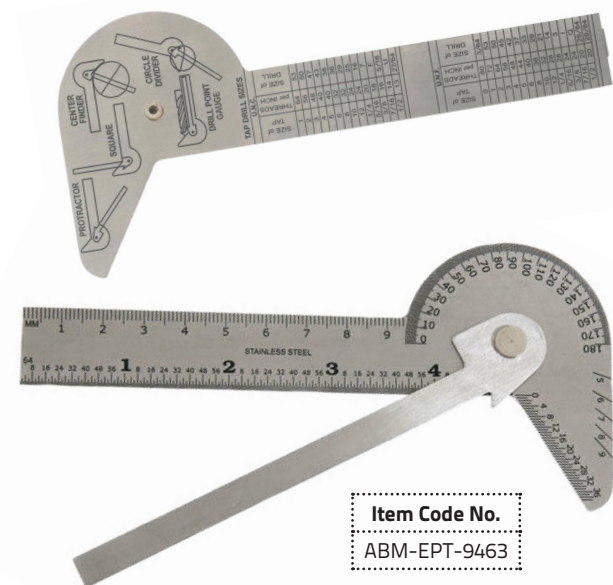

Item Code No.
ABM-EPT-9463

Depth Gauge



- Steel Rule with Hardened and Ground Steel Base.
- Spring tension Nut for easy depth measurement.
- Graduated in inches and m.m.
- Angular depth gauge can be used as a protractor for measuring angles 15°, 30° and 45° angles which are marked on the tool.

Item Code No.	Size
ABM-EPT-9485	6" Steel Rule
ABM-EPT-9486	12" Steel Rule

- A very famous and handy pocket sized angle protractor multi-purpose tool made of polished stainless steel construction for long lasting durability. Permanently etched graduations (64ths and mm)
- Made From Stainless Steel.
- Measuring Rule 100 mm (4")
- Center Finder for locating centers on shaft and circles.
- Tap and drill table shows popular tap sizes and corresponding drill sizes for American National Threads.
- Protractor for measuring and laying out angles.
- Circular Divider for dividing circles into sectors, polygons and PolyGram (up to nine equal parts).
- Can be used as Protractor, Center Finder, Square, Circle Divider, Drill point Gauge.
- Finish: Glossy Shiny Finish or Matt Finish (Non Shiny-Vernier Type).

Bore Gauge

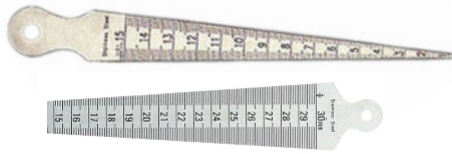

- For Measuring Of Cylindrical Bores, Bearing Works and Gaging Slots.
- Made From Stainless Steel.
- Finish: Glossy Shiny Finish or Matt Finish (Non Shiny-Vernier Type).
- Graduations Engraved For Permanent Use.
- Clearly etched graduations for inch on one side and mm on the other one

Item Code No.	Range	
	mm	Inch
ABM-EPT-9300	1 to 15	1/32 to 5/8
ABM-EPT-9301	15 to 30	5/8 to 1-1/8
ABM-EPT-9302	30 to 45	1-1/8 to 1-3/4
ABM-EPT-9303	45 to 60	1-3/4 to 2-23/64

Welding Taper Bore Gauge and Steel Ruler

Item Code No.
ABM-EPT-9735

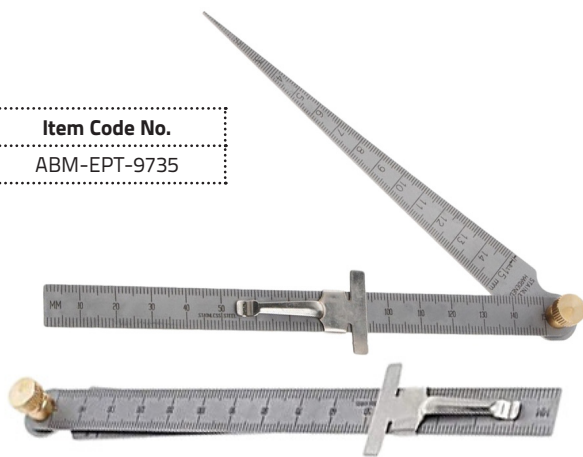

- It's a Combination of 1-15 mm Bore Gauge and Pocket Rule with clip MM & 0.5mm Locked with Adjustable Brass Screw.
- Finish: Glossy Shiny Finish or Matt Finish (Non Shiny-Vernier Type).

Dial Bore Gauge



- Packed in wooden case.
- Available without dial and with dial.
- Suitable for measuring diameters, roundness and taper of bores at any desired point and depth.
- Hardened and Ground HSS contact points.
- Complete with centering Bridge and protective cover for dial indicator.

Item Code No.	Size mm
ABM-EPT-9340	18 - 35 mm
ABM-EPT-9341	35 - 60 mm
ABM-EPT-9342	60 - 160 mm

Wire Gauge / Wire Gage (Round & Rectangular)



- Made from Polished Stainless Steel.
- Permanently deep etched graduations.
- Graduations in British and Metric systems. (S.W.G. & A.S.G. Standards).
- Gauges have a convenient decimal equivalents of each number.
- Popular Gauge for Gaging Iron Wire, Hot and Cold Rolled sheet Steel.

Item Code No.	Description
ABM-EPT-9350	Rectangular
ABM-EPT-9351	Round

Drill Gauge

Drill and Steel Wire Gage is used for selecting the correct size of twist drills and steel drill rod in smaller sizes. For convenience, each hole is marked with the size number and the corresponding decimal equivalent.

Item Code No.	Size
ABM-EPT-9320	No. 1 - 60
ABM-EPT-9321	1/16" - 1/2" by 64 ths
ABM-EPT-9322	A - Z
ABM-EPT-9323	1 mm to 13 mm
ABM-EPT-9324	61 - 80 (Steel)

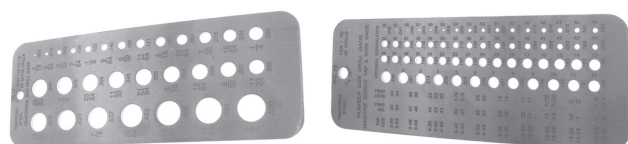

Feeler Gauge (Thickness Gauge)



- Made from excellent Quality tempered steel.
- Each leaf is approximately 3-1/2" long and 4" Long.

Item Code No.	No. of Leaves	Range	
		Inch	mm
ABM-EPT-9360	9	.0015" to .015"	0.5 to 0.60
ABM-EPT-9361	10	.0015" to .025"	0.5 to 0.80
ABM-EPT-9362	13	--	0.5 to 1.00
ABM-EPT-9363	20	--	0.5 to 1.00
ABM-EPT-9364	26	.0015" to .025"	0.5 to 1.00

Center Gauge

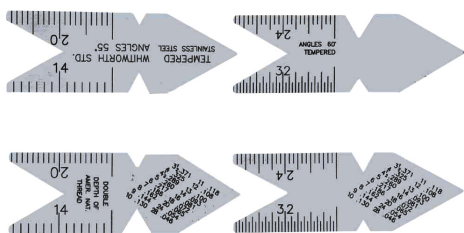

- Very Handy Gauge For Grinding & Setting Thread Cutting Tools.
- Made From Stainless Steel.
- Satin Chrome Finish.
- Permanently Deep Etched Graduations.
- Edge Profile Ground.
- Useful to find number of threads per inch by means of graduations in 14ths, 24ths and 32nds of an inch.

Item Code No.	Description
ABM-EPT-9305	55° Withworth Or English Standard
ABM-EPT-9306	60° US Standard or American Standard

Radius Gauge - Weld Gauge

- Manufactured from mild steel.
- For measuring of right angle welds.
- 3-12mm(1 complete Set.)

Item Code No.	Range	No. of Leaves
ABM-EPT-9770	3, 3.5, 4, 4.5, 5, 5.5, 6, 6.5, 7, 8, 10 & 12 mm	12

Radius Gauge (Ring Type)



- Handy device for checking radius of tools and dies easier and faster.
- Gauge features leaves for measuring both concave & convex radius.
- Each leaf is clearly stamped with the radius size.

Item Code No.	Range	No. of leaves
ABM-EPT-9388	1/32 to 17/64 by 1/64	16
ABM-EPT-9389	1/32 to 1/4	16
ABM-EPT-9390	17/64 to 1/2	18
ABM-EPT-9391	9/32 to 33/64 by 1/64	16
ABM-EPT-9392	0.75 to 5 by 0.25 mm	12
ABM-EPT-9393	5.5 to 13 by 0.5 mm	16
ABM-EPT-9394	3 to 12 by 1 mm	12

Radius Gauge (Locking Type)



- Handy device for checking radius of tools and dies easier and faster.
- Gauge features leaves for measuring both concave & convex radius.
- Each leaf is clearly stamped with the radius size.

Item Code No.	Range	No. of leaves
ABM-EPT-9370	1/32 to 1/4 by 1/64	34
ABM-EPT-9371	17/64 to 1/2 by 1/64	32
ABM-EPT-9372	1 to 7 mm	34
ABM-EPT-9373	7.5 to 15 mm	32
ABM-EPT-9374	15.5 to 25 mm	30
ABM-EPT-9375	0.75 to 5 by 0.25 mm	18
ABM-EPT-9376	5.5 to 13 by 0.5 mm	16



Screw Pitch Gauge



- Screw Pitch Gauge known as Thread Gauge, used to measure thread pitch or lead, number of threads per inch(TPI) and also the thread angle of a screw.
- Very Handy Tool for Gauging Threads, easy to use.
- Number of each leaf of thread pitch gauge represents pitch size.
- Made of high quality Tool Steel.
- Available for American National, Metric and English Threads.

Item Code No.	Range	No. Of Leaves	Description
ABM-EPT-9420	4 - 42	31	American V Thread
ABM-EPT-9421	4 - 84	52	American US Thread 60° UNC/UNF
ABM-EPT-9422	4-42 & 0.25-6.0	55	Combination
ABM-EPT-9423	0.25 - 2.5 mm	28	Metric ISO 60°
ABM-EPT-9424	0.25 - 6.0 mm	24	Metric 60°
ABM-EPT-9425	0.4 - 7.0 mm	21	Metric 60°
ABM-EPT-9426	Metric & Inch	52	Withworth 55° & Metric 60°
ABM-EPT-9427	4 to 62 & 0.25 to 6.0 mm	52	Combination of Withworth Standard 55° & Metric Standard 60°
ABM-EPT-9428	4 to 62 & 0.25 to 6.0 mm	58	Combination of Withworth Standard 55° & Metric Standard 60°
ABM-EPT-9429	4 - 62 G	28	Withworth Standard 55°
ABM-EPT-9430	8 - 28	6	Withworth Pipe Thread 55°
ABM-EPT-9431	10 - 40	14	US Thread 60°
ABM-EPT-9432	4 - 64	22	US Thread 60°
ABM-EPT-9433	12 - 80	16	UNF Thread 60°
ABM-EPT-9434	0.5 - 6.0	18	Metric ISO 60°
ABM-EPT-9435	4 - 60	26	With worth Thread 55°
ABM-EPT-9436	0.5 - 7.0	18	Metric ISO 60°
ABM-EPT-9437	0 - 10, 47-1/2°	12	British Association -BA
ABM-EPT-9438	4 - 80	28	Metric ISO 60°
ABM-EPT-9439	1 - 11.5 mm	22	Metric ISO 60°
ABM-EPT-9440	Metric & Inch	58	Inch & Metric + BSP 55° & Metric 60°

Screw Pitch Gauge

(51 leaves) (4-84 TPI)

- **ITEM CODE NO. ABM-EPT-9445**
- American National 60° threads, 51 leaves 4-84 TPI (teeth per inch)
- ABM screw pitch gages are among the most useful tools in any mechanics toolbox.
- They quickly determine the pitch of various threads.
- These gages consist of a substantial steel case with a number of folding leaves at both ends, each leaf having teeth corresponding to a definite pitch, marked on each leaf.
- ABM screw pitch gages are available in a wide range of sizes with different numbers of leaves in various pitch ranges with which to gage.
- English and metric threads are similar in form, but English threads are described in threads per inch and metric threads by the distance from one crest to the next.
- Leaves on all gages have a special narrow design, permitting checking internal threads in nuts, etc., as well as external threads.



Vernier Height Gauge

- Packed in wooden case.
- Most Suitable For Tool Room And Quality Control Applications In Manufacturing Areas.
- With Fine Adjustment.
- Stainless Steel Holding Brackets.
- Least Count 0.02 mm.
- Scale made from Stainless Steel.
- Removable Carbide Tipped Point.
- Reading Faces are Dull Chrome.

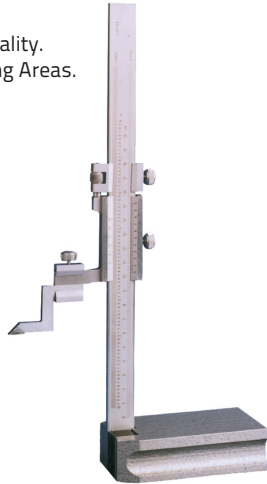

Item Code No.	Range	
	Inch	MM
ABM-EPT-9450	6	150
ABM-EPT-9451	12	300
ABM-EPT-9452	18	450

Screw Cutting Gauge

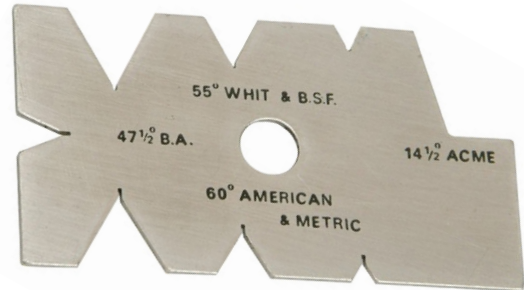

Item Code No.
ABM-EPT-9410

- Made from Stainless Steel in Stain Chrome finish.
- Deep etched graduations.
- Accurate thread profile 47-1/2° British Association & 14-1/2° Acme, 55° Withworth and BSF, 60° American and Metric.
- Overall Length is 2" (50 mm).

Acme Screw Cutting Gauge

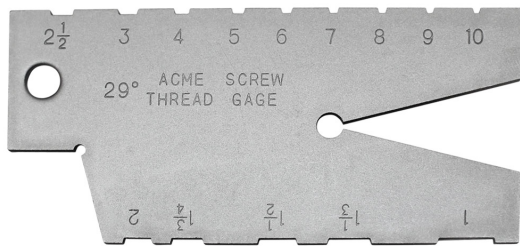

Acme Screw Thread Gauge

- Made of Polished Stainless Steel
- Clearly Etched Graduation
- Used for Gaging Thread Profiles 47-1/2° British Association, 14-1/2 Acme 60° American
- Acme Standard Screw Thread Gage is a standard for grinding and setting tools when cutting Acme threads, which have the same depth as square threads but the sides of the threads are at an inclination of 14-1/2 Deg (29 Deg included angle).
- This form of thread is used extensively and has in many instances replaced the square thread in machine construction.
- The advantages of the Acme thread is its strength and the ease by which it can be cut compared with square threads.
- The angles and edges of this gage are hardened, ground and carefully tested
- The angle on the thread cutting tool is checked on the large precision-ground V at the end of the gage.
- Used for grinding and setting acme thread cutting tools.
- Identical depth for all slots in the gauge.

Item Code No.
ABM-EPT-9760

Marking Gauge

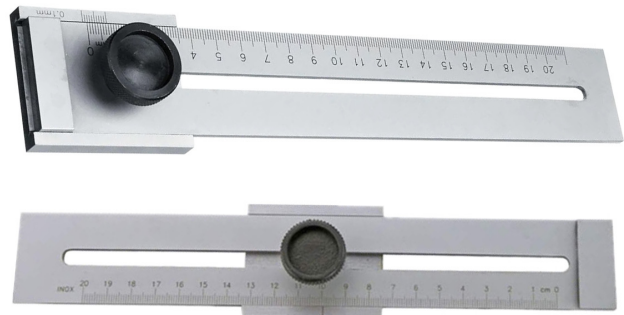

- Graduations are properly etched to give accurate measurements.
- Scale manufactured of stainless steel.
- Marking edge with metric graduations.
- A useful laying out tool made of stainless steel with a satin chrome finish.
- The beam is graduated in millimetres and has a hardened steel layout edge 40mm wide.
- The stock is locked into position with a knurled thumb screw.
- The tool can be used for a variety of marking out jobs from simply running a pencil line down the edge of a board to precisely gauging the length of tenons, the transferring of widths and any repetitive marking or laying out operation.
- Ideal woodworking tool can be used for a variety of marking out jobs.
- Finish: Glossy Shiny Finish or Matt Finish (Non Shiny-Vernier Type).

Protractor (Degree Protractors)

Item Code No.	Size
ABM-EPT-6463	80 mm
ABM-EPT-6464	120 mm
ABM-EPT-6465	150 mm

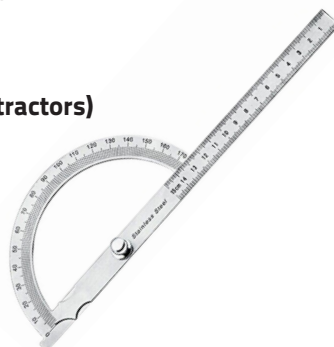

Item Code No.	Range	
	Inch	MM
ABM-EPT-9780	8	200
ABM-EPT-9781	10	250
ABM-EPT-9782	12	300

Twist Drill Grinding Gauges

- Overall Length 4-1/2" (114 mm).
- For twist drills with acute angle of 118° upto 2" (50 mm) diameter.
- Made of Stainless Steel.

Item Code No.
ABM-EPT-9490



Drill Point Gauge

With Hook Ruler



This gage was designed specifically for use in drill grinding. It provides a quick, accurate way for determining the correct drill point angle of 59° and the correct length of drill lips necessary for clean-cut drilling at maximum feeds and speeds.

The head is beveled to 59 degree (the correct drill point angle) It is also graduated in 1/32 along the 59 degree face for measuring the drill lips which should be of equal lengths

The hook rule has accurate, machine-divided graduations in 1/8, 1/16, quick-reading 1/32 and 64

Hook is adjustable and can be shortened or extended on either side of the rule, and may also be removed if desired

This gage was designed specifically for use in drill grinding. It provides a quick, accurate way for determining the correct drill point angle of 59 degree and the correct length of drill lips necessary for clean-cut drilling at maximum feeds and speeds

These rugged steel measures feature a satin chrome finish, sliding heads and adjustable and removable hook rules.

- For properly grinding 59° drill points and for measuring drill tips.
- Rule and slide are made of steel with satin chrome finish .
- Rigid rule is calibrated in 8ths, 16ths, 32nds and 64ths.
- End clip / Hook is adjustable and removable.
- Slide is calibrated in 32nds and 64ths.

Universal Grinding Gauges

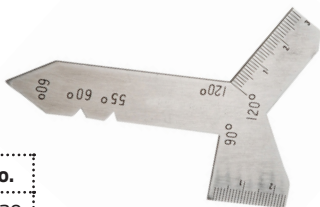

Item Code No.
ABM-EPT-9530

- Overall Length 3-3/4" (95 mm).
- Made of Polished Stainless Steel.
- Clearly etched graduations.
- Combines twist drill grinding gages, thread gage.
- Measures Square & hexagonal angles of 120°, 118°, 90°, 60°, 55°

Surface Gauge Tool Makers (Surface Marking Block / Gauges)

- Basic tool for machinist and toolmakers for accurately scribing line, transferring measurements and probing during inspection work.
- Polished and hardened steel base with double ended scribe.
- Bottom V. Grooved for cylindrical work.
- Front recessed for depressing spindle below base line can be locked to any angle fine adjustment.
- Has a fine adjustments for precise angular movement.
- Base has 2 retractable Gauge to set against edge of a surface plate.
- 1/4" (6.35 mm) hole drilled on adjustment knob for positioning a dial indicator.
- Can be used on flat or round surfaces.
- Fully hardened & ground base, which serves as an accurate reference surface.
- Adjustable spindle with scribe that can be rigidly secured at any position on the spindle.

Item Code No.	Base Diameter		length of Spindle		Diameter of Spindle	
	Inch	MM	Inch	MM	Inch	MM
ABM-EPT-9500	2-3/16 x 1-5/8 x 3/4	55 x 40 x 20	4 & 7	100 & 175	1/4	6.3
ABM-EPT-9501	3-1/4 x 2-1/2 x 1	82 x 63 x 25	9 & 12	225 & 300	3/8	9.5
ABM-EPT-9502	4 x 3-1/2 x 1-1/8	100 x 90 x 30	12 & 18	300 & 450	3/8	9.5
ABM-EPT-9503	3-1/4 x 2-1/2 x 1	82 x 63 x 25	9	225	3/8	9.5
ABM-EPT-9504	3-1/4 x 2-1/2 x 1	82 x 63 x 25	12	300	3/8	9.5



Surface Marking Blocks / Gauges (Round Base)

- Sturdy construction surface gage.
- Consists of Adjusting knob and hardened scriber.
- Round base made of close grain Cast Iron.
- Very useful for every workshop.
- Scribes are black oxidized.
- Chromed spindle for shiny finish.
- **Also available with Magnetic Base.**

Item Code No.	Height		Base Diameter	
	Inch	MM	Inch	MM
ABM-EPT-9520	12"	300	3-1/8"	80
ABM-EPT-9521	20"	500	3-1/8"	80
ABM-EPT-9522	40"	1000	6"	150



Tire Tread Feeler Gauge (Double Point Brass)

- Round Jaws construction for Inside & Outside measurement.
- Graduated in mm. and inch sizes.
- Made of Brass.
- Laser etched fine marking for better readouts.

Item Code No.	Size	Overall Length	
		Inch	MM
ABM-EPT-9845	0 - 50 mm	4"	100
ABM-EPT-9846	0 - 60 mm	4"	100



Brass Tyre Profile Depth Gauge PROFILE DEPTH GAUGE BRASS

- Made of Brass.
- Surface finely ground.
- With dove tail guiding and Vernier reading.

Item Code No.	Size	Overall Length	
		Inch	MM
ABM-EPT-9600	0 - 30 mm	4"	100
ABM-EPT-9601	0 - 50 mm	4"	100

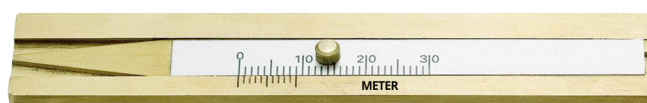

Tire Tread Feeler Gauge Single Point Brass

- Round Jaws construction for Inside & Outside measurement.
- Graduated in mm. and inch sizes.
- Made of Brass.
- Laser etched fine marking for better readouts.

Item Code No.	Size	Overall Length	
		Inch	MM
ABM-EPT-9840	0 - 50 mm	4"	100



Automatic Centre Punches



- Hardened and ground punch point.
- Force of impact can be regulated by turning the top knurled Cap.
- This Automatic Center punch or Marking Punch is great for Marking before drill on center.
- Built in Spring loaded punch mechanism for Single Hand Use.
- Pressing the head of the punch deliver a punch with built in mechanism.
- Light or Heavy Marking is adjustable by rotating the knurled Cap head.
- Fields Of Application : Stamping, Seals, Marking, Numbering, Tracing, Engraving.
- Used for Marking Light Dotting to Heavy Punching without having to use a hammer.
- Spring loaded center Punch can be used for marking on Metal, Wood and plastic.
- Automatic Center punches Heavy Duty can Punch, mark, scribe and start drill, nail or screw holes.
- Ideal for Machinist, Woodworkers and automotive repair pros.
- Points are made from Hardened Steel 55-58 HRC.
- Replacement points, shafts and moving parts made of hardened alloy steel.
- Point is replaceable and can be re-sharpen.
- Replaceable Points also available.
- Also available with Special Characters Marking in Bulk Quantities.
- Color Coating as per customer's requirement also available.

Available in following Styles

Material Options :

1. Brass Body
2. Steel Body / Black finish
3. Aluminium Body

Color Options :

1. Color Coated Body

Comfort Option :

1. With Plastic Color Ball Heads

Item Code No.	Size
ABM-PN-9700	Steel Body
ABM-PN-9701	Brass Body
ABM-PN-9702	Aluminium Body

Coated



With Ball Head

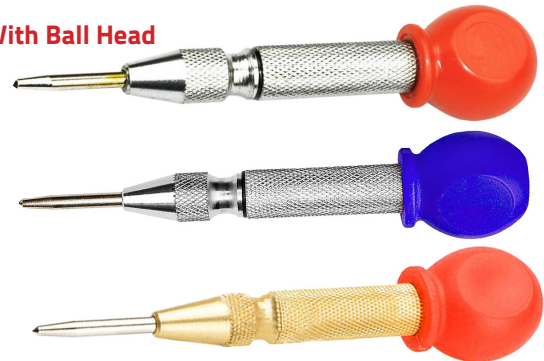

Automatic Centre Punches (Heavy Duty) (Marking Punch)

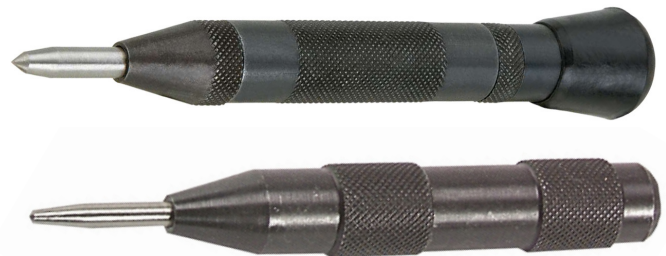

Item Code No.
ABM-PN-9715

- Single Hand Use Punch.
- Fields Of Application : Stamping, Seals, Marking, Numbering, Tracing, Engraving.
- Used for Marking Light Dotting to Heavy Punching without having to use a hammer.
- Also available with Special Characters Marking in Bulk Quantities.

Automatic Center Punch With Clip



Item Code No.

ABM-PN-10280

Pen Type Adjustable Force Automatic Centre Punch Tool

- For indenting the work-piece prior to drilling without the need for hammering.
- Delivers a punch when hand pressure is applied to knurled head.
- One handed operation.
- Adjustable force upto 13 Kgs simply by the knurled Cap on the head.
- Pen Type Holder & Epoxy Black finish for a Rust free life.
- Hardened & Ground Alloy Steel Pin of Hardness 60+2 HRC
- Knurled body for a firm grip to avoid any slippage
- Length: 120 mm

Drive Pin Punch - Hexagonal



- Pin punches are used to dislodge rivets and pins.
- Used for driving pins into or out of a workpiece.
- Each punch has the size stamped on the head.
- Made from Chrome Vanadium Steel.
- Supplied in Color Coated Finish (Yellow and Blue Running Color).
- Hexagonal Body for firm Grip.
- Uniformly heat treated.
- Available in individual sizes and also in set 6 in attractive plastic pouch.

Item Code No.	Overall Length		Diameter	
	Inch	mm	Inch	mm
ABM-PN-10160	6"	150	1/16"	1.5
ABM-PN-10161	6"	150	1/8"	3
ABM-PN-10162	6"	150	5/32"	4
ABM-PN-10163	6"	150	3/16"	5
ABM-PN-10164	6"	150	1/4"	6
ABM-PN-10165	6"	150	5/16"	8
ABM-PN-10166	Set of 6 Pcs Consisting of all above Punches			

Drive Pin Punches (4 Inch / 100 mm Long) (Short Drive Pin Punch)



- Metal pins and similar connectors are driven in or out of holes using a pin punch
- For removal, first use a starter punch to loosen the pin, then using pin punches to finish.
- Drive Pin Punches are made from Tool Steel.
- Hardened and Tempered.
- 4" long with knurled body for an easy grip and are in black oxidized finish.
- Available in individual sizes and also in set of 4 & 8 in attractive plastic pouches.

Item Code No.	Tip Dia.	
	Inch	mm
ABM-PN-9775	1/16	1.6
ABM-PN-9776	3/32	2.4
ABM-PN-9777	1/8	3.2
ABM-PN-9778	5/32	4.0
ABM-PN-9779	3/16	4.8
ABM-PN-9780	7/32	5.5
ABM-PN-9781	1/4	6.3
ABM-PN-9782	5/16	8.0
ABM-PN-9783	Set of 4 Drive Pin Punches in a Pouch consisting of 1/16", 3/32", 1/8" & 5/32"	
ABM-PN-9784	Set of 4 Drive Pin Punches in a Pouch consisting of 3/16", 7/32", 1/4" & 5/16"	
ABM-PN-9785	Set of 8 Drive Pin Punches in a Pouch consisting of 1/16", 3/32", 1/8", 5/32", 3/16", 7/32", 1/4" & 5/16"	

Punches
Punches
Punches
Punches
Punches
Punches
Punches
Punches
Punches
Punches

Drive Pin Punches

(6 Inch / 150 mm Long)



- Pin punches are used to dislodge rivets and pins.
- Used for driving pins into or out of a workpiece.
- Each punch has the size stamped on the head.
- Made from Carbon Steel.
- Uniformly heat treated.
- Length of Pin 1-3/4" (45 mm)
- Ground Finish and Knurled body for easy grip.
- Available in individual sizes and also in set of 4 & 8 in attractive plastic pouches.

Item Code No.	Tip Dia.	
	Inch	mm
ABM-PN-9795	1/16	1.6
ABM-PN-9796	3/32	2.4
ABM-PN-9797	1/8	3.2
ABM-PN-9798	5/32	4.0
ABM-PN-9799	3/16	4.8
ABM-PN-9800	7/32	5.5
ABM-PN-9801	1/4	6.3
ABM-PN-9802	5/16	8.0
ABM-PN-9803	Set of 6 Drive Pin Punches in a Pouch consisting of 3/32", 1/8", 5/32", 3/16", 1/4" and 5/16"	
ABM-PN-9804	Set of 8 Drive Pin Punches in a Pouch consisting of 1/16", 3/32", 1/8", 5/32", 3/16", 7/32", 1/4" & 5/16"	

Drive Pin Punches

(8 Inch / 200 mm Long) (Long Drive Pin Punches)



- Drive Pin Punches are used for driving out and removing already loosened pins & keys after initial movement by a solid or starting punch.
- Two piece construction allows the pin to have a separate hardness from the body which prevents 'peening' and also ensures complete straightness over such a long length.
- These round shank pin punches have clean and well cut knurling which provides positive, non slip grip.
- Two piece construction with a 3.3/4" (90 mm) long pin
- Drive Pin Punches are made from Tool Steel, Hardened and Tempered.
- Knurled body for easy grip and are in black oxidized finish.
- Total length 8" (Body length 4-1/2" and Drive Pin Section length 3-1/2").
- Available in individual sizes and also in a set of 5 in attractive plastic pouches.

Item Code No.	Tip Dia.		Body Dia.	
	Inch	mm	Inch	mm
ABM-PN-9815	1/8	3.2	7/16	11.00
ABM-PN-9816	5/32	4.0	7/16	11.00
ABM-PN-9817	3/16	4.8	7/16	11.00
ABM-PN-9818	1/4	6.3	1/2	12.70
ABM-PN-9819	5/16	8.0	1/2	12.70
ABM-PN-9820	3/8	9.5	9/16	14.00
ABM-PN-9821	Set of 5 Long Drive Pin Punches in a Plastic Pouch consisting of 1/8", 3/16", 1/4", 5/16" and 3/8"			

Drive Pin Punches (Heavy) (8 Inch / 200 mm Long) (Long Drive Pin Punches)



- Drive Pin Punches are used for driving out and removing already loosened pins & keys after initial movement by a solid or starting punch.
- Two piece construction allows the pin to have a separate hardness from the body which prevents 'peening' and also ensures complete straightness over such a long length.
- These round shank pin punches have clean and well cut knurling which provides positive, non slip grip.
- Two piece construction with a 3.3/4" (90 mm) long pin
- Drive Pin Punches are made from Tool Steel, Hardened and Tempered.
- Knurled body for easy grip and are in black oxidized finish.
- Total length 8" (Body length 4-1/2" and Drive Pin Section length 3-1/2").
- Available in individual sizes and also in a set of 5 in attractive plastic pouches.

Item Code No.	Tip Dia.		Body Dia.	
	Inch	mm	Inch	mm
ABM-PN-9825	1/8	3.2	9/16	14.00
ABM-PN-9826	3/16	4.8	9/16	14.00
ABM-PN-9827	1/4	6.3	9/16	14.00
ABM-PN-9828	5/16	8.0	9/16	14.00
ABM-PN-9829	3/8	9.5	9/16	14.00
ABM-PN-9830	Set of 5 Long Drive Pin Punches in a Plastic Pouch consisting of 1/8", 3/16", 1/4", 5/16" and 3/8"			

Parallel Pin Punches (Short Reach)



- Punch section Ground.
- Hardened and Tempered.
- Body heavy knurled with shiny black finish.
- Available in Individual Size and Set of 8 Pcs.
- Sets & individual Packed in attractive plastic pouch packing.

SET CONSIST (8 Pcs.):
3/32", 1/8", 5/32", 3/16", 7/32", 1/4", 5/16", 3/8"

Item Code No.	Size of Tip		Body Dia.		Total Length	
	Inch	mm	Inch	mm	Inch	mm
ABM-PN-9840	3/32"	2.4	3/8"	9.5	6"	150
ABM-PN-9841	1/8"	3.2	3/8"	9.5	6-1/4"	160
ABM-PN-9842	5/32"	4.0	3/8"	9.5	6-1/4"	160
ABM-PN-9843	3/16"	4.8	3/8"	9.5	6-1/4"	160
ABM-PN-9844	7/32"	5.5	3/8"	9.5	6-1/2"	165
ABM-PN-9845	1/4"	6.3	3/8"	9.5	6-3/4"	170
ABM-PN-9846	5/16"	8.0	1/2"	12.7	7"	175
ABM-PN-9847	3/8"	9.5	9/16"	14.3	7"	175
ABM-PN-9848	Set of 8 Parallel Pin Punches (Short Reach)					

Punches
Punches
Punches
Punches
Punches
Punches
Punches
Punches
Punches
Punches

Parallel Pin Punches (Long Reach)



- Punch Section, Hardened and Tempered.
- Heavy Knurled Body with Shiny Black Finish.
- Available in individual sizes and also in a set of five in attractive Plastic Pouch .

Item Code No.	Size of Tip	Body Dia.	Total Length
ABM-PN-9860	1/8"	3/8"	5"
ABM-PN-9861	3/16"	3/8"	6"
ABM-PN-9862	1/4"	1/2"	6-1/2"
ABM-PN-9863	5/16"	1/2"	7-1/2"
ABM-PN-9864	3/8"	5/8"	8-1/2"
ABM-PN-9865	Set of 5 Parallel Pin Punches (Long Reach)		

Rolling Pin Punch Set (9 Pcs. Set)

Item Code No.
ABM-PN-9720



- Roll Pin Punches have a nipple on the end that keeps them centered in the roll pin and prevent the punch from skidding off the pin.
- Rolling Pin Punches are made from High Quality Carbon Steel, Hardened and Ground.
- Knurled body for easy grip and are in black oxidized finish.
- Packed in attractive plastic pouches.
- Used by Gunsmith, Jewelers & Automotive Industries.
- Hemispherical recessed roll pins.

ROLLING PIN PUNCH SET CONSIST OF (9 Pcs.):
1/16", 5/64", 3/32", 1/8", 5/32", 3/16", 7/32", 1/4" & 5/16"

Grommet Setting Dies



- Manufactured from solid steel for inserting sheet brass washer & teeth grommets.
- Useful tool for setting up eyelets.
- Can be used on soft material.

Item Code No.	For Eyelet Size
ABM-PN-10245	10 mm
ABM-PN-10246	13 mm
ABM-PN-10247	16 mm
ABM-PN-10248	19 mm

Brass Pin Punches (Non Sparking)



- Brass Pin Punches prevent scarring of truck surface due to its softer than steel nature.
- These Brass punches are Non Sparking when working in areas with flammable fluids present.
- Provides gentle initial movement with a Steel Punch being used later to complete the job.
- Made from high quality Brass Hexagonal Stock.
- Ideal Punches for working in no mark, no spark situation.
- 3-1/2" (90 mm) Long.
- Available in individual sizes and also in a set of 8 pcs in attractive plastic pouches.

Also known as Brass Drive Pin Punches Set

Item Code No.	Size	
	Inch	mm
ABM-PN-9730	1/16	1.6
ABM-PN-9731	3/32	2.4
ABM-PN-9732	1/8	3.2
ABM-PN-9733	5/32	4.0
ABM-PN-9734	3/16	4.8
ABM-PN-9735	7/32	5.5
ABM-PN-9736	1/4	6.3
ABM-PN-9737	5/16	8.0
ABM-PN-9738	Set of above 8 Brass punches	

Centre Punches (Square Head & Round Head)



- Knurling on the shank provide a positive finger grip.
- Square head provides larger area for striking & prevents the punch from rolling off.
- Square head Center Punch comes with round Shank and Square Striking End.
- Made from Tool Steel, Hardened and ground.
- Black shiny finish / Black oxide Finish with knurled body for easy grip.
- Available in plastic pouch in individual sizes and also in a set of 5 pcs.

Item Code No.	Tip Dia.		Overall Length		Square Size	
	Inch	mm	Inch	mm	Inch	mm
ABM-PN-9740	1/16	1.5	4	100	3/8	9.5
ABM-PN-9741	5/64	2.0	4	100	3/8	9.5
ABM-PN-9742	3/32	2.5	4	100	3/8	9.5
ABM-PN-9743	9/64	3.5	4	100	3/8	9.5
ABM-PN-9744	5/32	4.0	4	100	3/8	9.5
ABM-PN-9745	1/8	3.2	4	100	3/8	9.5
ABM-PN-9746	3/16	4.8	4-1/2	115	7/16	11
ABM-PN-9747	1/4	6.3	5	125	9/16	14
ABM-PN-9748	Set of 5 Centre Punches in a Pouch consisting of 1/16", 5/64", 3/32", 9/64" and 5/32"					

Item Code No.	Tip Dia.		Overall Length	
	Inch	mm	Inch	mm
ABM-PN-9749	1/16	1.5	3	75
ABM-PN-9750	5/64	2.0	4	100
ABM-PN-9751	3/32	2.5	4	100
ABM-PN-9752	9/64	3.5	4	100
ABM-PN-9753	5/32	4.0	4	100
ABM-PN-9754	5/16	8.0	4	100
ABM-PN-9755	1/8	3.2	4	100
ABM-PN-9756	11/64	4.4	4	100
ABM-PN-9757	3/16	4.8	4-1/2	115
ABM-PN-9758	1/4	6.3	5	125
ABM-PN-9759	3/8	9.5	6	150
ABM-PN-9760	Set of 5 Centre Punches in a Pouch consisting of 1/16", 5/64", 3/32", 9/64" and 5/32"			

Punches



Punches
Punches
Punches
Punches
Punches
Punches
Punches
Punches
Punches
Punches

Center Punch

Set of 7 Pcs.



Item Code No.
ABM-PN-9765

- Black Shiny Finish / Black Oxidized Finish.
- Knurled Body for easy Grip.
- Made from Tool steel, Hardened & Ground.
- Set of 7 Pcs. packed in attractive Plastic Pouch.

SET CONSISTS OF (7 Pcs.):
1/16" (1.5mm), 5/64" (2 mm), 3/32" (2.5mm), 1/8" (3 mm),
5/32" (4 mm), 3/16" (5 mm) & 1/4" (6 mm)

Centring Punch

Hinge Centering Punch

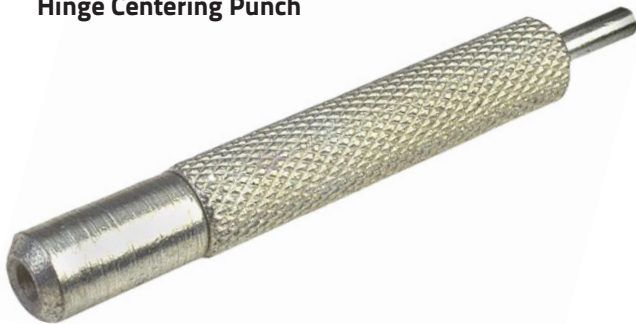

- For quickly starting screw holes when attaching countersink hardware such as hinges, hasps, hangers and drawer pulls.
- Spring loaded punch.
- punch made from hardened and tempered tool steel.
- Body and punch chrome plated.

Item Code No.	Body Dia.	Body Length
ABM-PN-9770	3/8" (9.5 mm)	2-1/2" (64 mm)

Prick Punches (Light)



- Made from Carbon Steel.
- Front taper and back head in ground finish.
- Knurled body for easy gripping.
- Uniformly heat treated.

Item Code No.	Dia at top of Taper	Body Dia.	Length
ABM-PN-10040	5/64" (2.0 mm)	9/32" (7.0 mm)	4" (100 mm)
ABM-PN-10041	3/32" (2.5 mm)	19/64" (7.5 mm)	4" (100 mm)
ABM-PN-10042	9/64" (3.5 mm)	5/16" (8.0 mm)	4" (100 mm)
ABM-PN-10043	5/32" (4.0 mm)	3/8" (9.5 mm)	4" (100 mm)
ABM-PN-10044	3/16" (4.8 mm)	3/8" (9.5 mm)	4" (100 mm)
ABM-PN-10045	Set of above 5 Pcs		

Taper Punches (Aligning Punches)



- Hardened and Tempered for long life.
- Knurled body for an easy grip.
- Shiny black finish.
- Punches are ground.
- Widely used in Industry and Auto Body Shops.
- Available in plastic pouch in individual sizes and also in set of 4 pcs. in each sizes

Item Code No.	Tip Dia	Body Dia.
ABM-PN-10060	1/8" (3.2 mm)	7" (175 mm)
ABM-PN-10061	3/16" (4.8 mm)	9" (225 mm)
ABM-PN-10062	1/4" (6.3 mm)	10" (250 mm)
ABM-PN-10063	5/16" (8.0 mm)	12" (300 mm)
ABM-PN-10064	Set of All Four Taper Punches in Pouch	

Prick Punches (Heavy)



- Made from High Quality Carbon Steel.
- Accurately Ground and Tempered.
- Enamel Painted body with polished working ends.
- Used for marking along scribed lines in layout work, piercing holes in light metals and aligning holes in two or more metal sheets marking intersecting Centre Lines, hole locations and drill starting points.

Item Code No.	Stock Size	Overall Length
ABM-PN-10080	1/4" (6 mm)	3" (75 mm)
ABM-PN-10081	3/8" (10 mm)	5" (125 mm)
ABM-PN-10082	1/2" (12 mm)	6" (150 mm)

Starting Punches (Heavy Duty)



- Enamel painted body with polished working ends.
- Made from high quality Carbon Steel.
- Accurately hardened and tempered.
- Suitable for installing pins & rivets and for starting their removal.

Item Code No.	Point Size	Stock Size	Length
ABM-PN-10090	1/16" (1.6 mm)	3/8" (10 mm)	5" (125 mm)
ABM-PN-10091	3/32" (2.4 mm)	3/8" (10 mm)	5" (125 mm)
ABM-PN-10092	1/8" (3.2 mm)	3/8" (10 mm)	5" (125 mm)
ABM-PN-10093	5/32" (4.0 mm)	3/8" (10 mm)	5" (125 mm)
ABM-PN-10094	3/16" (4.8 mm)	3/8" (10 mm)	5" (125 mm)
ABM-PN-10095	7/32" (5.5 mm)	3/8" (10 mm)	5-1/2" (137 mm)
ABM-PN-10096	1/4" (6.3 mm)	3/8" (10 mm)	5" (125 mm)
ABM-PN-10097	5/16" (8.0 mm)	1/2" (12 mm)	6" (150 mm)
ABM-PN-10098	3/8" (9.5 mm)	5/8" (16 mm)	6-1/2" (163 mm)
ABM-PN-10099	1/2" (12.0 mm)	5/8" (16 mm)	7" (175 mm)

Interchangeable Hollow Punch Set of 10 Pcs.



Item Code No.
ABM-PN-10240

- Made from high grade alloy steel.
- Each punch is hardened, tempered & ground to fine cutting edge for sharpness & durability.
- Handle is knurled for firm grip & safety.
- Punch body is grooved for quick & easy change.
- Ideal for punches clean & precise holes on leather, felt rubber & all soft material.

Revolving Punch Plier



Item Code No.
ABM-PWP-16571

- Revolving Punch of sizes 2 mm, 2.5 mm, 3 mm, 3.5 mm, 4 mm and 4.5 mm.
- Made from heavy gauge sheet metal.
- Size to be punched can be chosen by Revolving Spring load punch holder.

Punches
Punches
Punches
Punches
Punches
Punches
Punches
Punches

Arch Punches DIN 7200A

- To DIN 7200 Form A
- For stamping out or Punching cardboard, leather, rubber, sealing materials, plastics, cork, felt, fabric and other soft materials.
- Cutting edge hardened
- Shaft colored varnished.

Item Code No.	Size	
	Inch	MM
ABM-PN-10170	3/16	5
ABM-PN-10171	1/4	6
ABM-PN-10172	5/16	8
ABM-PN-10173	3/8	10
ABM-PN-10174	7/16	11
ABM-PN-10175	1/2	12
ABM-PN-10176	9/16	14
ABM-PN-10177	5/8	16
ABM-PN-10178	23/32	18
ABM-PN-10179	3/4	19
ABM-PN-10180	27/32	21
ABM-PN-10181	7/8	22
ABM-PN-10182	15/16	24
ABM-PN-10183	1	25
ABM-PN-10184	1-1/64	26
ABM-PN-10185	1-1/16	27
ABM-PN-10186	1-3/32	28
ABM-PN-10187	1-1/8	29
ABM-PN-10188	1-3/16	30
ABM-PN-10189	1-7/32	31
ABM-PN-10190	1-1/4	32
ABM-PN-10191	1-5/16	33
ABM-PN-10192	1-11/32	34
ABM-PN-10193	1-3/8	35
ABM-PN-10194	1-13/32	36
ABM-PN-10195	1-15/32	37
ABM-PN-10196	1-1/2	38
ABM-PN-10197	1-17/32	39
ABM-PN-10198	1-9/16	40
ABM-PN-10199	1-5/8	41
ABM-PN-10200	1-21/32	42
ABM-PN-10201	1-11/16	43
ABM-PN-10202	1-23/32	44
ABM-PN-10203	1-25/32	45
ABM-PN-10204	1-13/16	46
ABM-PN-10205	1-27/32	47



Item Code No.	Size	
	Inch	MM
ABM-PN-10206	1-7/8	48
ABM-PN-10207	1-15/16	49
ABM-PN-10208	2	50
ABM-PN-10209	2-5/64	52
ABM-PN-10210	2-5/32	54
ABM-PN-10211	2-3/16	55
ABM-PN-10212	2-9/32	57
ABM-PN-10213	2-19/64	58
ABM-PN-10214	2-3/8	60
ABM-PN-10215	2-15/32	62
ABM-PN-10216	2-1/2	63
ABM-PN-10217	2-9/16	65
ABM-PN-10218	2-21/32	67
ABM-PN-10219	2-11/16	68
ABM-PN-10220	2-3/4	70
ABM-PN-10221	5 Pcs Set (6, 10, 12, 16 & 19 mm)	
ABM-PN-10222	7 Pcs Set (6, 10, 12, 16, 19, 22 & 25 mm)	
ABM-PN-10223	7 Pcs Set (5, 8, 11, 14, 18, 21 & 24 mm)	
ABM-PN-10224	10 Pcs Set (6, 8, 10, 11, 13, 14, 16, 19, 22 & 25 mm)	

Leather Punch (Hollow Punches) (Belt Punches)

- Made from quality steel.
- Hardened, ground and Cutting edge is 35 HRC.
- Body round and knurled for better gripping, with black oxidized finish.
- Also used for Accurate hole in Gasket.
- Can be used on Materials like Light gauge Metal Sheet, Vinyl, Plastic, Leather.
- Sets can be supplied as per requirement.
- Also available in different attractive colors with powder coating.
- Inside Taper for Clearance.



Item Code No.	Size	
	Inch	MM
ABM-PN-9960	3/32	2
ABM-PN-9961	1/8	3
ABM-PN-9962	5/32	4
ABM-PN-9963	3/16	5
ABM-PN-9964	1/4	6
ABM-PN-9965	9/32	7
ABM-PN-9966	5/16	8
ABM-PN-9967	23/64	9
ABM-PN-9968	3/8	10
ABM-PN-9969	7/16	11
ABM-PN-9970	1/2	12
ABM-PN-9971	17/32	13
ABM-PN-9972	9/16	14
ABM-PN-9973	19/32	15
ABM-PN-9974	5/8	16
ABM-PN-9975	11/16	17
ABM-PN-9976	23/32	18
ABM-PN-9977	3/4	19
ABM-PN-9978	13/16	20
ABM-PN-9979	27/32	21
ABM-PN-9980	-	22
ABM-PN-9981	29/32	23
ABM-PN-9982	15/16	24
ABM-PN-9983	1	25
ABM-PN-9984	1-1/64	26
ABM-PN-9985	1-1/16	27
ABM-PN-9986	1-3/32	28
ABM-PN-9987	1-1/8	29
ABM-PN-9988	1-3/16	30
ABM-PN-9989	-	31
ABM-PN-9990	1-1/4	32
ABM-PN-9991	1-5/16	33
ABM-PN-9992	-	34
ABM-PN-9993	1-3/8	35
ABM-PN-9994	1-13/32	36
ABM-PN-9995	-	37

Item Code No.	Size	
	Inch	MM
ABM-PN-9996	1-1/2	38
ABM-PN-9997	-	39
ABM-PN-9998	1-9/16	40
ABM-PN-9999	1-5/8	41
ABM-PN-10000	-	42
ABM-PN-10001	1-11/16	43
ABM-PN-10002	-	44
ABM-PN-10003	-	45
ABM-PN-10004	1-13/16	46
ABM-PN-10005	-	47
ABM-PN-10006	1-7/8	48
ABM-PN-10007	1-15/16	49
ABM-PN-10008	2	50
ABM-PN-10009	2-1/32	52
ABM-PN-10010	2-1/16	53
ABM-PN-10011	2-1/8	54
ABM-PN-10012	2-5/32	55
ABM-PN-10013	2-3/16	56
ABM-PN-10014	2-1/4	57
ABM-PN-10015	2-9/32	58
ABM-PN-10016	2-5/16	59
ABM-PN-10017	2-3/8	60
ABM-PN-10018	2-13/32	61
ABM-PN-10019	2-7/16	62
ABM-PN-10020	2-15/32	63
ABM-PN-10021	2-1/2	64
ABM-PN-10022	2-17/32	65
ABM-PN-10023	2-19/32	66
ABM-PN-10024	2-5/8	67
ABM-PN-10025	2-21/32	68
ABM-PN-10026	2-23/32	69
ABM-PN-10027	2-3/4	70

Punches



Punches
Punches
Punches
Punches
Punches
Punches
Punches
Punches
Punches
Punches

Nail Punches (Square Head and Round Head)



- Nail Punch, designed for driving nail heads below the surface of wood.
- The working end is cupped to follow the nail head without sliding off.
- Can be used to remove nails that have an exposed point.
- Place the recessed tip against the point of the nail and strike the punch with a hammer to back the nail out of the hole .
- The striking end , chamfered to prevent breakage.
- Knurled round shank provides a positive non-slip grip.
- Round Head or Square Head punches are made from Tool Steel.
- Square Head 3/8" (9.5mm) provides a large striking area and prevents the punch from rolling off.
- Hardened and Tempered.
- Available in individual sizes and also in a set of five in plastic pouch.

Item Code No.	Tip Dia.		Length	
	Inch	mm	Inch	mm
ABM-PN-9890	1/16	1.6	3	75
ABM-PN-9891	5/64	2.0	4	100
ABM-PN-9892	3/32	2.4	4	100
ABM-PN-9893	9/64	3.6	4	100
ABM-PN-9894	5/32	4.0	4	100
ABM-PN-9895	5/16	8.0	4	100
ABM-PN-9896	1/8	3.2	4	100
ABM-PN-9897	11/64	4.4	4	100
ABM-PN-9898	3/16	4.8	4-1/2	115
ABM-PN-9899	1/4	6.3	5	125
ABM-PN-9900	3/8	9.5	6	150
ABM-PN-9901	Set of 5 Nail Punches in a Pouch consisting of 1/16", 3/32", 1/8", 5/32" and 3/16"			

**While placing Oder please mention
Square Head or Round Head**

Letter & Number Punches (Set) (Letter and Number Sets) (Steel Stamps)



Also known as Letter Stamps or Number Stamps or Letter Punch or Figure Punch

- Stamping end is sufficient hardened to ensure long life and the striking end is soft. Meanwhile ,this prevents the punch from splintering during use.
- Hardened sticks of punches.
- In black finish are packed in plastic boxes.
- Number Punch Set 0-8 (Total 9 Sticks). No. 6 is inverted to make No. 9.
- Letter Punch Set A-Z (Total 27 sticks).
- Combination Set consists of 27 Letters Punch set and 9 Number Punch Set (Total 36 Sticks).
- Special characters & Special fonts also available.
- Available in Plastic Box & Wooden Box packing.

Letter Sets (A-Z, 27 Sticks) Item Code no.	Number Sets (Figure Sets) (0-9, 9 Sticks) Item Code no.	Combination Sets (Number +Figure Sets) (0-9 & A-Z, 36 Sticks) Item Code no.	Size	
			Inch	MM
ABM-PN-9910	ABM-PN-9925	ABM-PN-9940	1/16	1.5
ABM-PN-9911	ABM-PN-9926	ABM-PN-9941	3/32	2.5
ABM-PN-9912	ABM-PN-9927	ABM-PN-9942	1/8	3.0
ABM-PN-9913	ABM-PN-9928	ABM-PN-9943	5/32	4.0
ABM-PN-9914	ABM-PN-9929	ABM-PN-9944	3/16	5.0
ABM-PN-9915	ABM-PN-9930	ABM-PN-9945	1/4	6.0
ABM-PN-9916	ABM-PN-9931	ABM-PN-9946	5/16	8.0
ABM-PN-9917	ABM-PN-9932	ABM-PN-9947	3/8	10.0
ABM-PN-9918	ABM-PN-9933	ABM-PN-9948	1/2	12.0
ABM-PN-9919	ABM-PN-9934	ABM-PN-9949	5/8	16.0
ABM-PN-9920	ABM-PN-9935	ABM-PN-9950	3/4	19.0

Optical Center Punch Set



Item Code No.
ABM-PN-10290

- This Tool Guarantees to achieve a Precise Punch Location Every time
- Supplied with 2 Optical Punches. One with Cross Hair with Target Style Marks.
- Also Included two hardened steel punches (60° & 90°) and Base Holder to hold all the Punches.
- Align the Position by optical Punch, magnified, and then use the steel Punch to get the mark.
- Just look down the magnifying lens and align the cross hairs with the mark on your work piece, replace with the supplied punch and give it a tap.
- Includes a bull's eye and cross hair lens
- Efficient and precision punching of hole centers
- Magnified center dot and circle for accurate punching.
- Used for marking, punching, stoking and riveting.
- 9x acrylic lens.

Wad Punch Kit



- Made from high grade alloy steel.
- Handle is forged, fully heat-treated & hardened to take heavy hammer impact.
- The pin on handle is spring loaded to eject slug & alloy holes to be accurately centered.
- Each punch is grounded to fine cutting edge, specially hardened & tempered for sharpness & durability.
- Perfect for punching holes in leather, felt, rubber, fiber, plastic & corks etc.

Item Code No.	Size Range	Size Included
ABM-PN-10270	5-32 mm	5, 6, 8, 10, 12.5, 16, 20 25 & 32 mm

Wad Punch Kit



PUNCH HEAD

- Precision-made high grade alloy steel & fine grounded to sharp cutting edge
- Innovative 'twist-&-lock' system allow quick change of the punch head safety & prevents accidental misfits

HANDLE

- Solid drop forget steel, hardened for heavy hammer impact bright nickel-plated knurled body for firm grip & comfort
- Accommodates 2 punches to make washers, gaskets & punched holes on material such as felt, rubber, fiber, leather, plastics & corks etc.

Item Code No.	Size Range	Size Included
ABM-PN-10265	3-20 mm	3, 4, 6, 8, 10, 12, 14, 16, 18 & 20 mm
ABM-PN-10266	3-30 mm	3, 4, 6, 8, 10, 12, 14, 16, 18, 20, 24, 26, 28 & 30 mm
ABM-PN-10267	3-40 mm	3, 4, 6, 8, 10, 12, 14, 16, 18, 20, 24, 26, 28, 30, 32, 34, 36, 38 & 40 mm

Gasket Punching Table

6-38 mm



- Can be easily used on any workbench.
- Light weight only Approx. 12 Kg.
- Easy to handle.
- Standard punch sizes supplied are 6, 7, 8, 9, 10, 11, 12, 13, 16, 19, 22, 25, 28, 32, 35 and 38 mm.
- Can punch gaskets washers, shims out of asbestos, rubber, Fiber, Oil paper, Brass, Copper, Aluminum and most thin metal sheets.
- All punches are hardened and tempered for maximum life, punching table also hardened.
- Punches can be re-sharpened by simple grinding to retain cutting edge.

Item Code No.	Punches Included
ABM-PN-10260	6, 7, 8, 9, 10, 11, 12, 13, 16, 19, 22, 25, 28, 32, 35 & 38 mm

Transfer Punches

A transfer punches is a punch (usually in an index set) of a specific outer diameter and extends the entire length of the punch (except for the tip). Transfer punches, used to tightly fit the tolerances of an existing hole and, when struck, precisely transfer the center of that hole to another surface.

This transfer punch makes it easy to perfectly align holes when manufacturing components. Made from durable carbon steel with hardened working ends these punches stand up to repeated use. The punch set comes with a handy storage case for easy organization.

Item Code No.
ABM-PN-10110

- Set of 28 Punches
- Length 4-7/8"
- Size Ranging From 3/32" To 17/32"
(3/32 – 1/2 x 64ths & 17/32)
- Ideally Suitable For Tool Maker's & Machinist.
- Eliminates the guesswork when transferring threaded, drilled, or reamed holes
- Heat Treated and Tempered.
- Black Oxidized Finish.



Universal Transfer Punch & Aligner



- All parts are made from steel.
- Hardened for longer life.
- Perfect hole center alignment assured.
- Replaces different sizes regular Transfer punches.
- To execute, spring loaded knurled body is to be pushed down until it is in contact with the work surface. A light stroke on the punch will mark the workpiece below, right in the centre of the hole.
- Will accommodate itself automatically to any hole size in the range approximately 3/16" to 1-3/16".
- Good for transferring hole centers using a template with varying hole sizes.
- The alignment cone slides in an outer cup which squares the whole assembly to the workpiece when pressed down on the template.
- The sliding centre punch may then be struck to mark the workpiece.
- Ideal for Toolmakers, Machinist, Machine and as well as Model Makers.

Item Code No.	Range	
	Inch	mm
ABM-PN-10120	3/16" to 5/8"	5 to 15
ABM-PN-10121	3/16" to 1-3/16"	5 to 30
ABM-PN-10122	Set of 2Pcs.	

Utility Punch & Scriber



- Utility punch and scriber is a Combination of Punch & Scriber.
- Utility punch is used for punching hole or as a Scriber in sheet metal.
- Hexagonal Body for comfortable grip.
- Ideal for Punching Holes in sheet metal.
- Can also be used as a Scriber.
- Hardened Point.
- Utility Punch made of Tool Steel.

Item Code No.	Tip Dia	Body Dia.
ABM-PN-10130	7-1/2" (190 mm)	5/32" (4.0 mm)

13 Pc combo Pin Punch Set

4" and 8" Drive Pin punches

- Very handy pin punch set.
- Consists of eight popular sizes in 4" (100 mm) long and five popular sizes in 8" (200 mm) long drive pin punches.
- Very useful set for machinists, hobbyist, automobile and construction industry.
- Packed in attractive plastic pouch and outer color box.

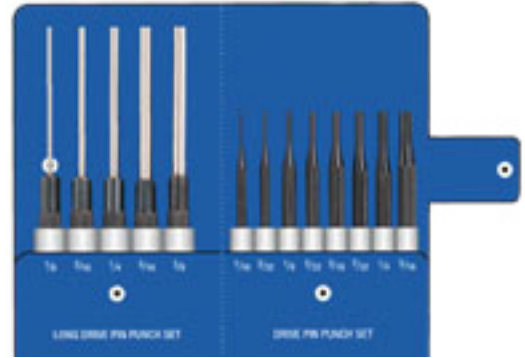

Item Code No.	Set Description
ABM-PN-10140	Set consisting of 4" (100 mm) long 1/16", 3/32", 1/8", 5/32", 3/16", 7/32", 1/4" & 5/16" and 8" Long consisting sizes 1/8", 3/16", 1/4", 5/16" and 3/8"

14 Pc combo Punch Set

- Very handy punch set.
- Consists of five popular sizes of 8" (200 mm) long drive pin punches, eight non sparking brass punches 3-1/2" (90 mm) long and one automatic centre punch 5" (125 mm) long.
- Available in attractive plastic pouch.



Item Code No.	Set Description
ABM-PN-10145	Set consisting of 8" (100 mm) Long Drive Pin Punches 1/8", 3/16", 1/4", 5/16" & 3/8" and 3-1/2" (90 mm) Long Brass Pin Punches consisting sizes 1/16", 3/32", 1/8", 5/32", 3/16", 7/32", 1/4" & 5/16" and Automatic Centre Punch 5" (125 mm) Long

Punch & Chisel Holder



- Steadily Holds punches, chisels and other tools when striking with a hammer.
- Reduces the risk of hand injury.
- Great for use in tight spaces.
- Steel frame with rust resistant finish.
- Nylon tip holds tool firmly in place.

Item Code No.	Body Dia.	Body Length
ABM-PN-10150	3/8" (9.5 mm)	2-1/2" (64 mm)

Anvil - Cast Iron

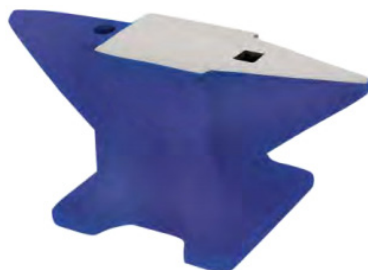

Anvils, these are manufactured from cast steel that allows these to be used for far more rigorous applications than a conventional cast iron anvil. The anvil face is precision ground and provided with Pritchel & Hardy holes. The beak is strong and can be used for bending applications. Anvil body has an attractive oven baked finish. An unbreakable, indispensable tool for any workshop

ANVIL – CAST IRON
ANVIL – CAST IRON WITH STEEL PLATE

Item Code No. Cast Iron	Item Code No. Cast Iron with Steel Plate	Size Kg.
ABM-VC-10410	--	5
ABM-VC-10411	--	10
ABM-VC-10412	--	15
ABM-VC-10413	--	20
ABM-VC-10414	ABM-VC-10421	25
ABM-VC-10415	--	30
ABM-VC-10416	-	35
ABM-VC-10417	ABM-VC-10422	50
ABM-VC-10418	ABM-VC-10423	75
ABM-VC-10419	ABM-VC-10424	100
ABM-VC-10420	ABM-VC-10425	150

G Clamp (Drop Forged) (C Clamp)



- General Purpose Clamp For Application In Metal Working, Fabrication And Welding Works.
- Also Available in Malleable Iron Body.
- Drop Forged With Strong Ribbed Body.
- Screw Made Of Steel.
- Copper Finish Screw.
- Also Available in Mini Series.
- Available in Standard & Heavy Duty.
- Finish : Normal Painted / Wrinkle Painted.

Item Code no.	Size	
	Inch	mm
ABM-WWT-10300	1	25
ABM-WWT-10301	2	50
ABM-WWT-10302	3	75
ABM-WWT-10303	4	100
ABM-WWT-10304	5	125
ABM-WWT-10305	6	150
ABM-WWT-10306	8	200
ABM-WWT-10307	10	250
ABM-WWT-10308	12	300
ABM-WWT-10309	14	350
ABM-WWT-10310	18	450

G Clamp (Ductile) (C Clamp)

- Frame made from ductile cast iron.
- Steel Screws with sliding T Bar Handle and Swivel Shoes.

Item Code no.	Size	
	Inch	mm
ABM-WWT-10340	3	75
ABM-WWT-10341	4	100
ABM-WWT-10342	5	125
ABM-WWT-10343	6	150
ABM-WWT-10344	8	200
ABM-WWT-10345	10	250
ABM-WWT-10346	12	300
ABM-WWT-10347	14	350
ABM-WWT-10348	18	450



Work Holding Device



G Clamp (Sheeted / Welded / Pressed) (C Clamp)



- Special Quality Steel Sheet With Steel Screw.

Item Code no.	Size	
	Inch	mm
ABM-WWT-10320	1	25
ABM-WWT-10321	2	50
ABM-WWT-10322	2-1/2	63
ABM-WWT-10323	3	75
ABM-WWT-10324	4	100
ABM-WWT-10325	5	125

Corner Clamps



- Counter-sunk holes for mounting to a work bench.
- Smoothly rolled, threaded screws with steel sliding pins.
- Die-cast aluminum construction provides strength.
- Use to make frames, repair window screens and storm doors and to splice molding and trim.
- Mount to a bench to help in splicing, doweling, gluing and nailing.

Item Code no.	Size	
	Inch	mm
ABM-WWT-10390	3	75
ABM-WWT-10391	4	100

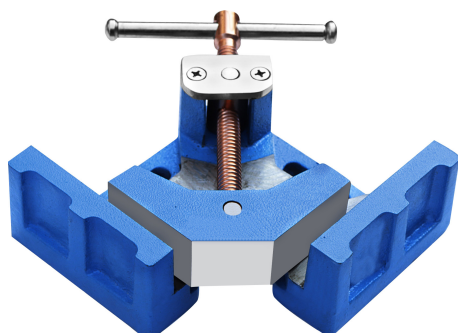

T Bar Cramps (T Bar Clamps)

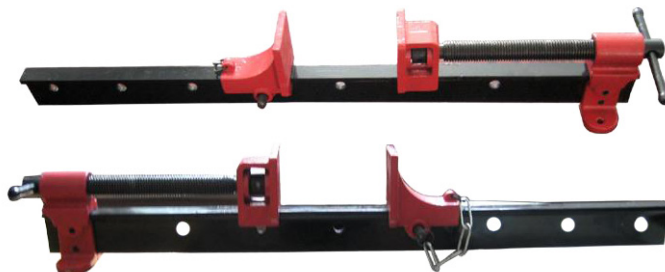

- 'T' made From Steel.
- Also available '1' Bar Clamps.
- Head & Slide Made Out Of C.I. Or Malleable Iron.
- The sliding jaw is fastened to T-bar by inserting a steel pin through one of the locating holes along the bar.
- Available in Cast Iron Jaws and Malleable Steel Jaws.
- Acme thread for smooth running.

Item Code no.	Size	
	Feet	mm
ABM-WWT-10360	2'	600
ABM-WWT-10361	2-1/2'	750
ABM-WWT-10362	3'	900
ABM-WWT-10363	3-1/2'	1050
ABM-WWT-10364	4'	1200
ABM-WWT-10365	4-1/2'	1350
ABM-WWT-10366	5'	1500
ABM-WWT-10367	5-1/2'	1650
ABM-WWT-10368	6'	1800
ABM-WWT-10369	6-1/2'	1950
ABM-WWT-10370	7'	2100
ABM-WWT-10371	8'	2400

**While placing order please mention
Cast Iron Jaws or Malleable Steel Jaws.**

Self Centering Corner Vice

- Used for Welding Perfect 90° Corner on Square Tube, Round Tube and Angle and Channel Iron.
- Slots in base plate are provided so you can fix the vice to work bench or machine table.
- Swing Jaw Design, Single Handle Jaw Two-way Rotation can be adjusted, Precision Right Angle Clamping Tool.
- Perfect for welding, framing, drilling, doweling, making cabinet, installing furniture, frame and aquarium, etc.

Item Code no.	Size	Width of Jaws	Opening of Jaws
ABM-WWT-10393	4" / 100 mm	100 mm	100 mm

Work Holding Device



F Clamps (F Bar Cramps)

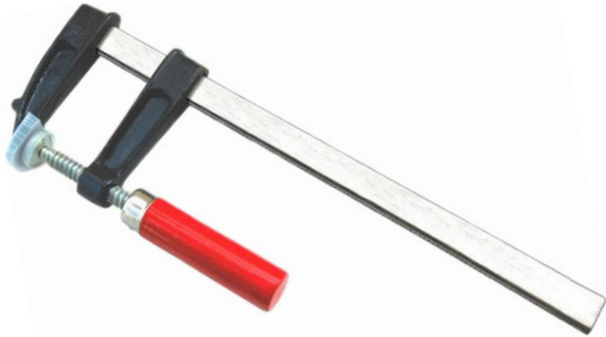

This clamp is having Laminated Steel, Ribbed for extra strength and durability, Powder Coated, Screw and Lever Zinc Plated to prevent rust.

Item Code no.	Size mm
ABM-WWT-10400	50 x 100
ABM-WWT-10401	50 x 150
ABM-WWT-10402	50 x 200
ABM-WWT-10403	80 x 150
ABM-WWT-10404	80 x 200
ABM-WWT-10405	120 x 200
ABM-WWT-10406	120 x 250
ABM-WWT-10407	120 x 500
ABM-WWT-10408	120 x 800

Bearing Puller (Available in 2 Legs and 3 legs)



- Made from Selected Steel, Black Lacquered / Chrome Plated.
- For removing Gears, Sprockets, Bearings, Pulleys and much more.
- Reversible legs and body.
- Reversible jaws for inside and outside pulls. Reversible for internal or external use.
- Hex head forcing screws suitable for use with ratchet wrench or combination spanner.

2 Legs Item Code No.	3 Legs Item Code No.	Size	
		Inch	mm
ABM-VC-10430	ABM-VC-10450	3	75
ABM-VC-10431	ABM-VC-10451	4	100
ABM-VC-10432	ABM-VC-10452	6	150
ABM-VC-10433	ABM-VC-10453	8	200
ABM-VC-10434	ABM-VC-10454	10	250
ABM-VC-10435	ABM-VC-10455	12	300
ABM-VC-10436	ABM-VC-10456	14	350
ABM-VC-10437	ABM-VC-10457	16	400
ABM-VC-10438	ABM-VC-10458	18	450
ABM-VC-10439	ABM-VC-10459	20	500
ABM-VC-10440	ABM-VC-10460	24	600

Parallel Clamps (Toolmaker's)

- Hardened and Tempered Jaws.
- Highly useful for holding small work together when drilling, Tapping, welding, assembling etc.
- Clamps include spring clip and retaining ring.
- Shiny Black Finish.
- Universally used by toolmakers and gunsmiths for close, precision holding of unusual shapes for welding, brazing, scribing, drilling. A must for scope, sight or bolt work.
- Screw Heads are drilled allowing use of a pin for tightening.

Item Code no.	Jaw Opening		Jaw Length	
	Inch	mm	Inch	mm
ABM-VC-10490	1-1/4"	30	2"	50
ABM-VC-10491	1-3/4"	44	2-1/2"	60
ABM-VC-10492	2-1/4"	56	3"	75
ABM-VC-10493	2-3/4"	70	4"	100
ABM-VC-10494	3-1/2"	88	5"	125
ABM-VC-10495	4-1/2"	115	6"	150
ABM-VC-10496	6"	150	8"	200
ABM-VC-10497	4 PC Set of length 2", 2-1/2", 3" & 4"			

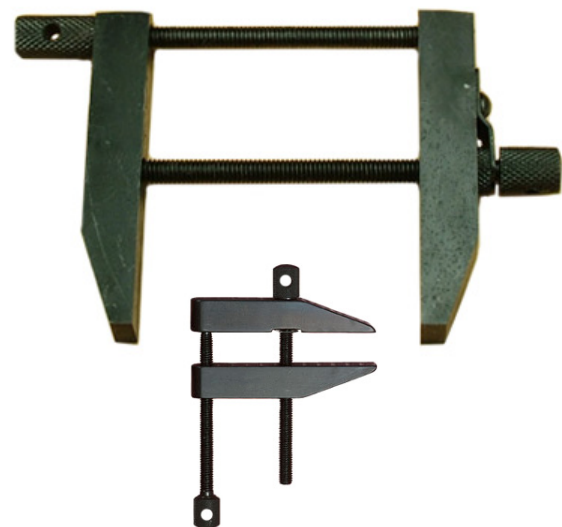

Clamping Kits

- Available with wooden Box and Metallic Box.
- Set of 34 Pcs in Wooden Box.
- Set of 58 Pcs in Metallic Box.

Item Code No. 34 Pcs Set	Item Code No. 58 Pcs Set	Size
ABM-VC-11580	ABM-VC-11576	14 - 12 mm
ABM-VC-11581	ABM-VC-11577	16 - 12 mm
ABM-VC-11582	ABM-VC-11578	18 - 12 mm
ABM-VC-11583	ABM-VC-11579	18 - 16 mm



34 Pcs. Clamping Kit Contains Following

Item Code No. 34 Pcs Set	T-Slot Nuts 4 Pcs.	Clamping Stud 4 Pcs. Each	Flanged Nuts 2 Pcs.	Coupling Nuts 2 Pcs.	Strap Clamp 2 Pcs.	Height Plates Adjustments 2 Pcs.
ABM-VC-11580	14-12 mm	M12 x 80 M12 x 100 M12 x 160 M12 x 200	M12	M12	12 x 100	2-50 2-100
ABM-VC-11581	16-12 mm	M12 x 80 M12 x 100 M12 x 160 M12 x 200	M12	M12	12 x 125	2-50 2-100
ABM-VC-11582	18-12 mm	M12 x 80 M12 x 100 M12 x 160 M12 x 200	M12	M12	M16 x 125	2-50 2-100
ABM-VC-11583	18-16 mm	M16 x 80 M16 x 100 M16 x 160 M16 x 200	M16	M16	M16 x 160	2-50 2-100

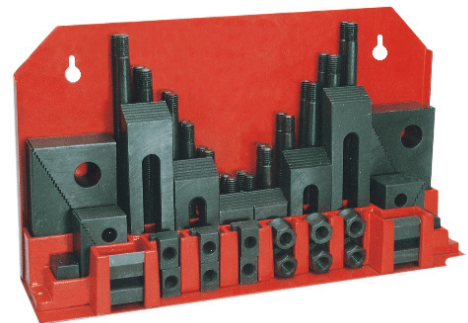

58 Pcs. Clamping Kit Contains Following

Item Code No. 58 Pcs Set	T-Slot Nuts 6 Pcs.	Clamping Stud 4 Pcs. Each	Flanged Nuts 6 Pcs.	Coupling Nuts 4 Pcs.	Stepped Strap Clamp 2 Pcs. Each	Step Blocks 2 Pairs (4 Pcs) each
ABM-VC-11576	14-12 mm	M12 x 63 M12 x 80 M12 x 100 M12 x 125 M12 x 160 M12 x 200	M12	M12	12 x 80 12 x 100 12 x 125	1 2 Pairs 2 2 Pairs 3 2 Pairs
ABM-VC-11577	16-12 mm	M12 x 63 M12 x 80 M12 x 100 M12 x 125 M12 x 160 M12 x 200	M12	M12	12 x 80 12 x 100 12 x 125	1 2 Pairs 2 2 Pairs 3 2 Pairs
ABM-VC-11578	18-12 mm	M12 x 63 M12 x 80 M12 x 100 M12 x 125 M12 x 160 M12 x 200	M12	M12	12 x 80 12 x 100 12 x 125	1 2 Pairs 2 2 Pairs 3 2 Pairs
ABM-VC-11579	18-16 mm	M16 x 63 M16 x 80 M16 x 100 M16 x 125 M16 x 160 M16 x 200	M16	M16	3 Pcs Each 16 x 125 16 x 150	1 2 Pairs 2 2 Pairs 3 2 Pairs



Work Holding Device



Woodworking Vice

Record Type

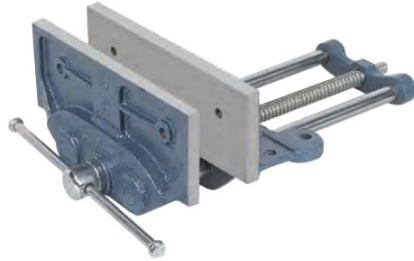

- Ideal for technical Institutes / Universities / Schools.
- Robust construction.
- Popular for do it yourself enthusiast.
- Body of cast iron.
- Spindle screw, sliding rods and handle is of high quality steel.

Item Code No.	Size	
	Inch	mm
ABM-WWT-10530	6	150
ABM-WWT-10531	7	175
ABM-WWT-10532	8	200
ABM-WWT-10533	9	225
ABM-WWT-10534	10	250
ABM-WWT-10535	12	300

Woodworking Vice

(Wood Workers Vice) (Quick Release)

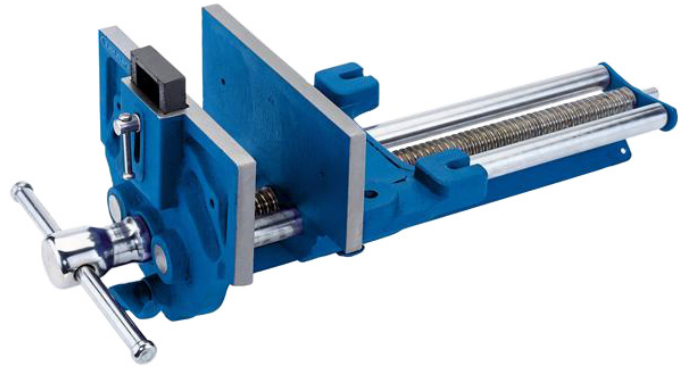

- A woodworking vice manufactured from close grain grey cast iron with a steel main screw for a long and trouble-free working life.
- Accurately machined housing coupled with solid steel guide rods assure a smooth sliding true parallel action for the jaw, free from side or cross deflection.
- This vice has a toe-in feature so that when fully closed the jaws only meet at the top to provide even clamping on the whole depth of the work piece.
- The adjustable front stop or dog gives an additional cramping facility when used in conjunction with a bench stop.
- Cast iron Frame with Steel Spindle.

Item Code No.	Size	
	Inch	mm
ABM-WWT-10550	6	150
ABM-WWT-10551	7	175
ABM-WWT-10552	8	200
ABM-WWT-10553	9	225

Woodworking Vice (Wood Workers Vice)

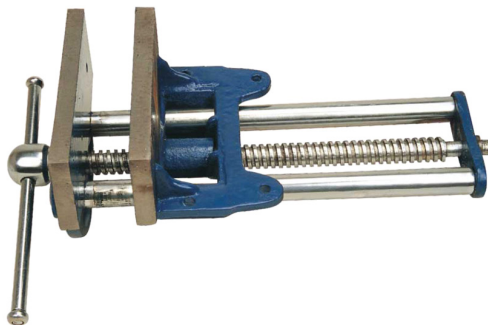

- Made from robust castings and are designed with generous jaw area which gives even clamping on the whole depth of the workpiece.
- Long life is assured with replaceable nut, corrosion resistant screw and handle.
- The square body seating enables easy fitting to work bench and large diameter slide bars run in accurately machined guide holes to provide a smooth parallel movement.
- Vice body and sliding jaw have provision for attaching wooden liners to protect the vice, work piece and working tools.

Item Code No.	Size	
	Inch	mm
ABM-WWT-10540	6	150
ABM-WWT-10541	7	175
ABM-WWT-10542	8	200
ABM-WWT-10543	9	225
ABM-WWT-10544	10	250
ABM-WWT-10545	12	300

Hand Vice with Wing Nut



Item Code No.
ABM-JWT-8000

- Malleable Iron Jaws have serrations.
- Wing Nut Adjustments.
- Very useful for model makers etc.
- Overall Length 6-1/2", Jaw Opening 5/8".

Leg Vice

The Blacksmiths' Leg Vice (aka Post Vice) firmly holds hot iron while it is hammered, chiselled or twisted. A normal Engineers Vice may shatter after such treatment because of the brittle nature of Cast iron from which they are made – although Malleable Iron is more resistant.

The Leg ensures that the forces it is subjected to are transmitted through to the floor.



Item Code No.	ABM-VC-10520	ABM-VC-10521
Size	4" (100 mm)	6" (150 mm)
Width of Jaws in mm	100	150
Opening of Jaws in mm	100	150
Depth of Jaws in mm	125	135
Length Overall in mm	375	390
Height Overall in mm	520	540
Width Overall in mm	100	150
Weight Approx Kg.	20	27

Draw Vice



- These Vices are used to Draw Wire

Item Code No.	Size	
	Inch	mm
ABM-VC-10510	4	100
ABM-VC-10511	5	125
ABM-VC-10512	6	150
ABM-VC-10513	8	200
ABM-VC-10514	10	250
ABM-VC-10515	12	300

Hand Vice



- Use to hold small objects tight while grinding, drilling, filing, hammering, sanding, shaping, etc.
- Jaws have vertical and horizontal V grooves for holding round objects.
- Use a hand vise and save your fingers.
- Hand vise has a handle attached to a set of jaws which can clamp down on various items.
- The jaws can be tightened with the assistance of wing screws, and they typically have a spring catch which keeps them open to the width they are set at.
- The jaws are also typically textured to increase their traction, ensuring that items in the hand vise do not slip.

Item Code no.	Size	
	Inch	mm
ABM-VC-10470	3	75
ABM-VC-10471	4	100
ABM-VC-10472	5	125
ABM-VC-10473	6	150
ABM-VC-10474	8	200

Baby Vice (Swivel Base)



- Very versatile unit.
- Ideal vise for small jobs.

Item Code no.	Size Inch
ABM-VC-10680	1-1/4"
ABM-VC-10681	1-5/8"
ABM-VC-10682	2"
ABM-VC-10683	2-3/8"
ABM-VC-10684	3"

Work Holding Device



Baby Vice (Fixed Base)



- Very versatile unit.
- Ideal vise for small jobs.

Item Code no.	Size Inch
ABM-VC-10700	1-1/4"
ABM-VC-10701	1-5/8"
ABM-VC-10702	2"
ABM-VC-10703	2-3/8"
ABM-VC-10704	3"

Baby Vice (Fixed Base) (Table Vice) (Baby Bench Vice)

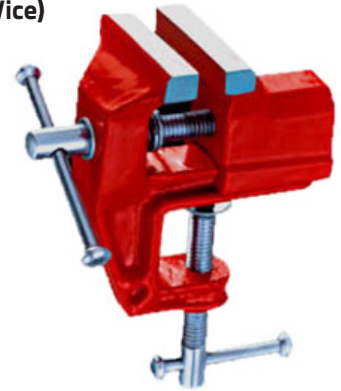

- Very versatile unit.
- Ideal vise for small jobs.

Item Code No.	Size	
	Inch	mm
ABM-VC-10710	1"	25
ABM-VC-10711	1-1/2"	40
ABM-VC-10712	2"	50
ABM-VC-10713	2-1/2"	60
ABM-VC-10714	3"	75
ABM-VC-10715	4"	100

Baby Vice (Swivel Base) (Table Vice) (Baby Bench Vice)



- Very versatile unit.
- Ideal vise for small jobs.

Item Code No.	Size	
	Inch	mm
ABM-VC-10730	1"	25
ABM-VC-10731	1-1/2"	40
ABM-VC-10732	2"	50
ABM-VC-10733	2-1/2"	60
ABM-VC-10734	3"	75
ABM-VC-10735	4"	100

Chain Pipe Vice



- Compact, portable and easily fixed to bench, post stand.
- Cast Iron Body.
- Replacement drop forged steel jaws.
- High tensile steel chain with positive adjustment nut and handle.
- Used for powerful Grip.

Item Code No.	Size	
	Inch	mm
ABM-PWP-10560	2	50
ABM-PWP-10561	3	75
ABM-PWP-10562	4	100
ABM-PWP-10563	6	150
ABM-PWP-10564	8	200

Pipe Vice Stand (Self Locking Pipe Vice)



- Any Colour of your choice.
- Normal Painted/Wrinkle Painted.
- Self Locking Pipe Vice stand also popular in the name of Hinged Pipe Vice Stand.
- The frame and base are hinged together.
- The replaceable steel jaws are accurately machined, hardened and tempered.
- The handle and main screw are also of steel while the frames and bases are of strong SG Iron casting guaranteed unbreakable.
- Complete with stand and Vice.
- Stand and vice also available separately.

Item Code No.	Vices it can hold	
	Inch	mm
ABM-PWP-10580	1-1/2" to 3"	37 to 75
ABM-PWP-10581	4"	100

Pipe Vice (Self Locking)

- Any Colour of your choice.
- Normal Painted/Wrinkle Painted.
- Self Locking Pipe Vice also popular in the name of Hinged Pipe Vice.
- The frame and base are hinged together.
- The replaceable steel jaws are accurately machined, hardened and tempered.
- The handle and main screw are also of steel while the frames and bases are of strong SG Iron casting guaranteed unbreakable.
- Stand also available separately.

Item Code No.	Size	
	Inch	mm
ABM-PWP-10590	1-1/2	37
ABM-PWP-10591	2	50
ABM-PWP-10592	2-1/2	63
ABM-PWP-10593	3-1/2	87
ABM-PWP-10594	4-1/2	112
ABM-PWP-10595	6	150



Work Holding Device



Pipe Vice (Open Type)

- Pipe vices are design to endure the heaviest pipe work fitted with long jaws to hold pipe firmly without any crushing of bending.
- Heavy Duty Cast Iron Tough Construction.
- Ideal Vice for Plumbers.
- Spindle Screw of quality steel for long life.
- Replaceable Jaws is provided.



Item Code No.	Size Inch
ABM-PWP-10610	1/8" - 1-1/4"
ABM-PWP-10611	1/4" - 2"
ABM-PWP-10612	1/4" - 3"
ABM-PWP-10613	1/4" - 4"
ABM-PWP-10614	2" - 6"
ABM-PWP-10615	2" - 8"
ABM-PWP-10616	2" - 10"

Pipe Vice (Round Pillar)

- Pipe vice provided with square steel pillar or Round Grinding Pillar.
- Replaceable steel jaws.

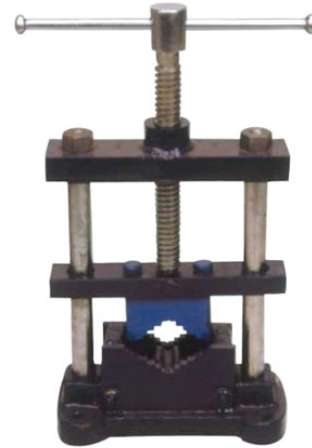

Item Code No.	Size	
	Inch	mm
ABM-PWP-10640	1-1/2"	37
ABM-PWP-10641	2"	50
ABM-PWP-10642	3"	75
ABM-PWP-10643	4"	100

Pipe Vice (Unbreakable, SG Iron Body) Open Type Replaceable Jaws

- S.G. ductile iron guaranteed unbreakable steel body.
- Ideal vice for plumbers.
- Spindle screw of quality steel for long life.
- Replaceable jaw is provided.



Item Code No.	Size	
	Inch	mm
ABM-PWP-10630	2"	50
ABM-PWP-10631	3"	75
ABM-PWP-10632	4"	100

Pipe Vice (Pillar Type, Changeable Jaws)

- Pipe vice provided with square steel pillar or Round Grinding Pillar.
- Replaceable steel jaws.



Item Code No.	Size Inch
ABM-PWP-10660	1-1/2"
ABM-PWP-10661	2"
ABM-PWP-10662	3"
ABM-PWP-10663	4"
ABM-PWP-10664	6"

Bench & Drill Press Vice Multifunction

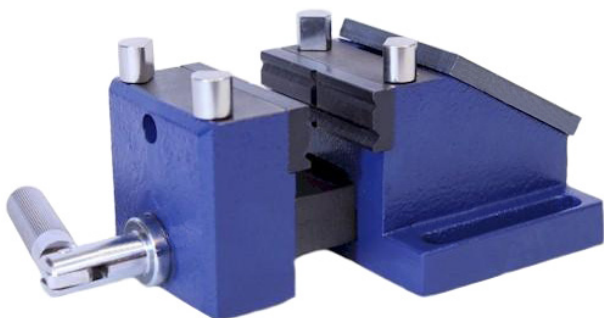

- Manufactured from High Quality steel grade cast iron.
- 1/4"-3" pipe Jaw Capacity .
- 6" Pipe capacity using 4 Pins.
- 3" (75mm) square Anvil.
- 4 Pins For Gripping odd shape Pc.

Item Code No.	Jaw Width	Jaw Depth	Jaw Opening
ABM-VC-11590	3" (75 mm)	1-3/4" (45 mm)	3-3/4" (95 mm)

Armature Bearing Puller Vice Heavy Duty

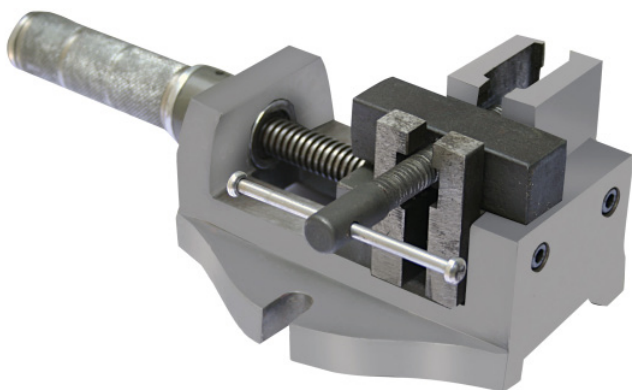

- It's a specialty vice designed for removing bearings from the armature shafts of portable power tools like marble cutter, grinders.

Item Code No.	ABM-VC-11175
Size in Inches	4" (100 mm)
Width of Jaws in mm	120
Opening of Jaws in mm	75
Depth of Jaws in mm	60
Length of Jaws in mm	250
Height Overall in mm	85
Width Overall in mm	155
Weight Approx Kg.	5

Multipurpose Bench Vice

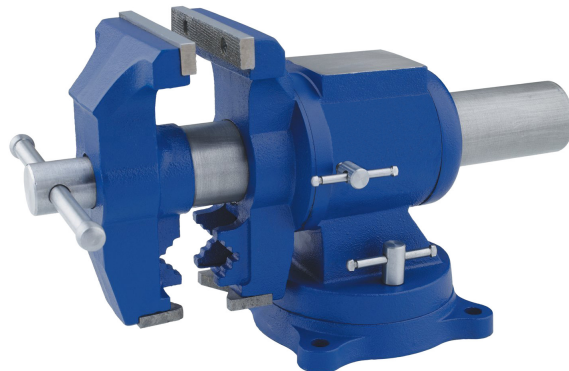

- Multi-purpose Rotating Bench Vice.
- Parallel Jaws.
- Head swivel 360 degree.
- Full 360 degree rotational jaws.
- 'V' jaws provide 4 point holding power.

Item Code No.	ABM-VC-10740	ABM-VC-10741	ABM-VC-10742
Size in Inches	4" (100 mm)	5" (125 mm)	6" (150 mm)
Width of Jaws in mm	100	140	165
Opening of Jaws in mm	100	130	145
Depth of Jaws in mm	80	80	80
Length of Jaws in mm	400	445	465
Height Overall in mm	210	235	245
Width Overall in mm	200	195	215
Weight Approx Kg.	15.5	18	22

Self Centering Shaft Vice (Crank Shaft Vice) (Fitted with Ball Bearings)



Item Code No.	Size mm
ABM-VC-11430	80
ABM-VC-11431	150

Bench Vice (Fixed Base)



- Sock resisting Cast Iron Body, free from sand holes, pits, blow holes, scabs and other imperfections.
- Jaws are made of special Carbon Steel properly heat-treated grinded and serrated to ensure a fast non slip.
- Horizontal and Vertical 'V' is provided for round section work.

Item Code No.	Size	
	Inch	mm
ABM-VC-10750	2-1/4"	60
ABM-VC-10751	2-1/2"	65
ABM-VC-10752	3"	80
ABM-VC-10753	3-1/2"	90
ABM-VC-10754	4"	100
ABM-VC-10755	4-1/2"	115
ABM-VC-10756	5"	125
ABM-VC-10757	6"	150
ABM-VC-10758	8"	200
ABM-VC-10759	10"	250
ABM-VC-10760	12"	300

Bench Vice (Swivel Base)

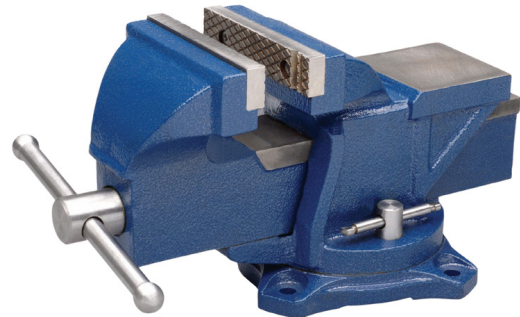

- Sock resisting Cast Iron Body, free from sand holes, pits, blow holes, scabs and other imperfections.
- Jaws are made of special Carbon Steel properly heat-treated grinded and serrated to ensure a fast non slip.
- Horizontal and Vertical 'V' is provided for round section work.

Item Code No.	Size	
	Inch	mm
ABM-VC-10800	2-1/4"	60
ABM-VC-10801	2-1/2"	65
ABM-VC-10802	3"	80
ABM-VC-10803	3-1/2"	90
ABM-VC-10804	4"	100
ABM-VC-10805	4-1/2"	115
ABM-VC-10806	5"	125
ABM-VC-10807	6"	150
ABM-VC-10808	8"	200
ABM-VC-10809	10"	250
ABM-VC-10810	12"	300

Bench Vice (Fixed Base) (All Steel)

- Vices are fabricated from special steel for mounting on work table, for general workshop use.
- Body is fabricated of hot rolled steel welded carefully.
- Serrated Jaws, made of carbon Steel, properly heat treated to ensure firm non slip grip.

Item Code No.	Size	
	Inch	mm
ABM-VC-10780	3"	75
ABM-VC-10781	3-1/2"	90
ABM-VC-10782	4"	100
ABM-VC-10783	4-1/2"	115
ABM-VC-10784	5"	125
ABM-VC-10785	6"	150
ABM-VC-10786	8"	200



Work Holding Device



Bench Vice (Swivel Base) (All Steel)

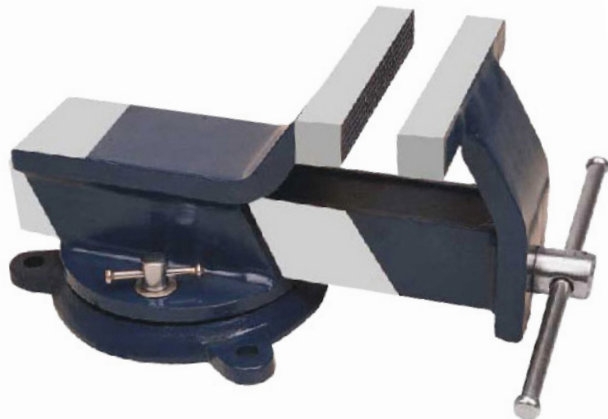

- Vices are fabricated from special steel for mounting on work table, for general workshop use.
- Body is fabricated of hot rolled steel welded carefully.
- Serrated Jaws, made of carbon Steel, properly heat treated to ensure firm non slip grip.

Item Code No.	Size	
	Inch	mm
ABM-VC-10830	3"	75
ABM-VC-10831	3-1/2"	90
ABM-VC-10832	4"	100
ABM-VC-10833	4-1/2"	115
ABM-VC-10834	5"	125
ABM-VC-10835	6"	150
ABM-VC-10836	8"	200

Drill Vice German Type

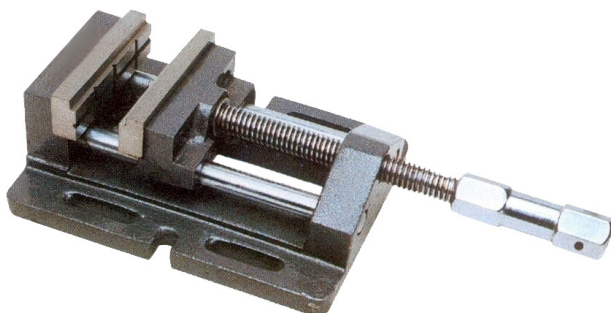

- Body made out of special graded casting.
- 'V' groove is provided for irregular sections.
- Moving jaws runs smoothly on two grinded rods.

Item Code No.	Size	
	Inch	mm
ABM-VC-10850	3"	75
ABM-VC-10851	4"	100
ABM-VC-10852	5"	125

Bench Vice (Precision Tool Room Bench Vice) (Extra Heavy duty) (German Type)

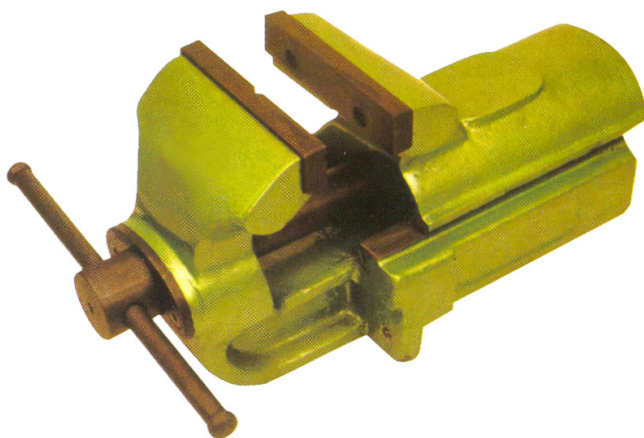

- Jaws are made of special Carbon Steel properly heat-treated grinded and serrated to ensure a fast non slip.
- Horizontal and Vertical 'V' is provided for round section work.

Item Code No.	Size	
	Inch	mm
ABM-VC-10870	4"	100
ABM-VC-10871	5"	125
ABM-VC-10872	6"	150

Offset Steel Bench Vice

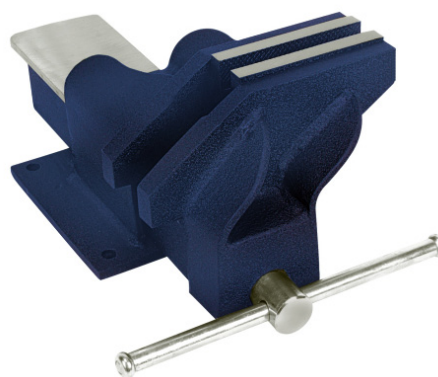

- The new design of our OFFSET VISE can hold long and odd shaped job.
- Ideal for irregular Jobs.
- With no limit of depth of jaws.
- The slide is provided with double ribs to ensure long time accuracy.
- Suit for milling & drilling machine.
- This OFFSET VISE can be set as common vise also.
- It is made of quality casting and steel.
- The vise can be used in engineering, automobile and fabrication workshops.

Item Code No.	ABM-VC-10895	ABM-VC-10896
Size in Inches	4" (100 mm)	6" (150 mm)
Weight Approx Kg.	9	17

Work Holding Device



Off Center Bench Vise

- The new design of our OFF CENTRE VISE can hold long and odd shaped job.
- It can be swivelled 360°, having locking arrangements to keep it fixed.
- The slide is provided with double ribs to ensure long time accuracy.
- Horizontal / Vertical & 2 direction.
- Suit for milling & drilling machine.
- This OFF CENTER VISE can be set as common vise also.
- It is made of quality casting and steel.
- The vise can be used in engineering, automobile and fabrication workshops.



Item Code No.	Jaw Width	
	Inch	mm
ABM-VC-10890	2-1/2"	65
ABM-VC-10891	4"	100
ABM-VC-10892	6"	150

Drill Press Vise Moveable Jaw



- Manufactured from graded cast iron.
- These vise jaws are adjustable and can hold round pieces or flat work pieces.
- Jaw are made of tool steel hardened and precision ground.

Item Code No.	Jaw Width	
	Inch	mm
ABM-VC-10900	4-1/2"	114

Precision 3 Way Universal Drill Press Vises



- Manufactured from carbon steel.
- Jaws are hardened.
- The Vise is precision Ground throughout can be used in three positions Horizontal, Vertical and Straight has four precision surfaces.

Item Code No.	Jaw Width	
	Inch	mm
ABM-VC-10910	2-3/8"	60
ABM-VC-10911	3-1/2"	88
ABM-VC-10912	5-1/4"	133

Quick Release Steel Vise

**Precision 2" Inches Quick Release Steel Vise For Micro Machining
Milling Drilling Grinding**

Item Code No.
ABM-VC-11600

- Made of Quality Tool Steel.
- Jaw Width: 2" / 50 mm
- Horizontal and Vertical V-grooves to hold any round stock
- 1-1/2" long x 5/8" tall throat capacity
- 3-3/4" long x 2-3/8" wide slotted base
- Overall Dimensions: 2-3/8" wide x 5-3/16" long x 1-5/8" tall
- This is a great quality little vise for compact / micro machining

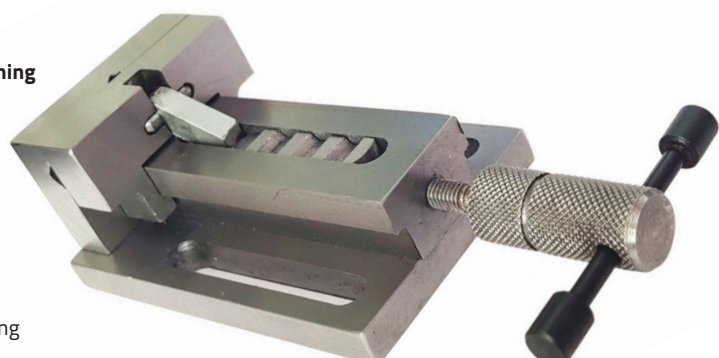

Tilting Jaw Drill Press Vises

- Manufactured from graded cast iron Precision milled.
- The vise has a tilting head that can clamp any non parallel part and automatically equalize the pressure.
- The jaws have horizontal and vertical grooves for holding round stock.
- It has a knurled handle which allows quick adjustments and also has a positional bar for applying torque.



Item Code No.	Jaw Width	
	Inch	mm
ABM-VC-10920	3"	76
ABM-VC-10921	4"	102

Precision 3 Way Drill Vise Uni-Grip

- Manufactured from graded cast iron.
- This vise has side faces which are fully ground allowing right angle positioning in 3 directions horizontal, vertical and straight.
- With 3 Mounting Options

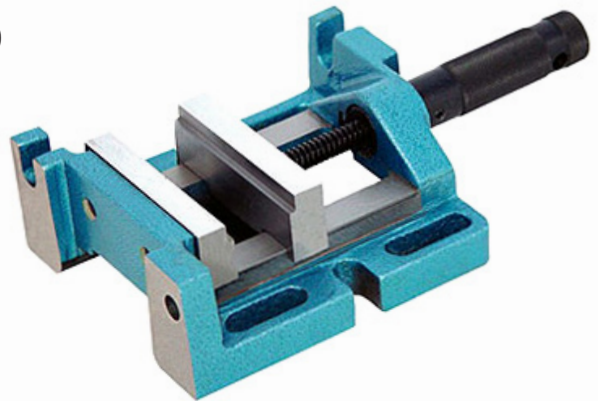

Item Code No.	Jaw Width	
	Inch	mm
ABM-VC-10925	3"	75
ABM-VC-10926	4"	100
ABM-VC-10927	5"	125

Quick Acting Vises

- Manufactured from graded cast iron.
- Heavy duty both jaws with vertical & horizontal 'V' jaws both jaws have seat for retaining flat or round pieces jaws are made of normal steel & it can be replaced.
- Quick acting vises is spring loaded for quick holding work pieces.

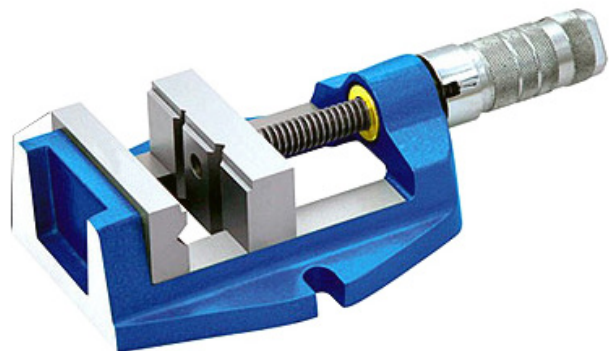

Item Code No.	Jaw Width	
	Inch	mm
ABM-VC-10930	5"	125

Quick Change Precision Vise

- Manufactured from tool steel hardened 55 - 60 HRC, and high precision ground Parallelism <0.015 mm.
- Each Vise is accuracy certified.

Item Code No.	Jaw Width	
	Inch	mm
ABM-VC-11085	6"	70

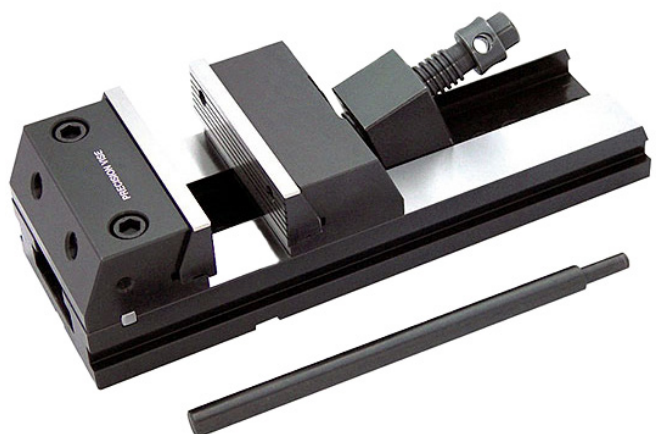

Work Holding Device



Drill Press Vice (Heavy Duty)

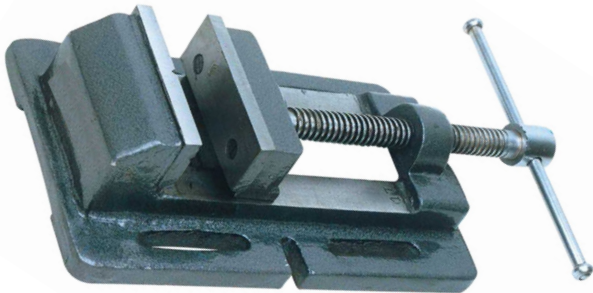

- Four slots for easy clamping to tables.
- Body made from selected Cast Iron.
- Works well with High Pressure drilling Machine.

Item Code No.	Size	
	Inch	mm
ABM-VC-10940	3"	75
ABM-VC-10941	4"	100
ABM-VC-10942	5"	125
ABM-VC-10943	6"	150
ABM-VC-10944	8"	200
ABM-VC-10945	12"	300

Drill Press Vice (Grinding Vice) (Multiside Use)



- Seasoned Cast Iron used.
- Ground Vise bed for consistent, smooth movement and accuracy.
- Hardened V Grooved tool Steel jaws.

Item Code No.	Size	
	Inch	mm
ABM-VC-10970	2"	50
ABM-VC-10971	3"	75
ABM-VC-10972	4"	100
ABM-VC-10973	5"	125

Drill Press Vice (Precision)

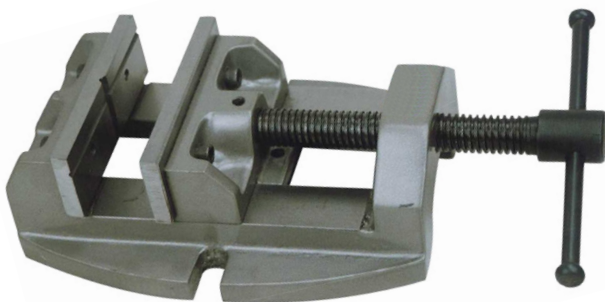

- Body made from selected Cast Iron.
- Works well with High Pressure drilling Machine.

Item Code No.	Size	
	Inch	mm
ABM-VC-10950	3"	75
ABM-VC-10951	4"	100
ABM-VC-10952	5"	125

Drill Vice Precision



- Body made from selected Cast Iron.
- Works well with High Pressure drilling Machine.

Item Code No.	Size	
	Inch	mm
ABM-VC-10990	2-1/2"	63
ABM-VC-10991	3"	75
ABM-VC-10992	4"	100
ABM-VC-10993	5"	125
ABM-VC-10994	6"	150

Drill Press Vice

- Manufactured from graded cast iron.
- These vise jaws are adjustable and can hold round pieces or flat work pieces.
- Jaw are made of tool steel hardened and precision ground.
- Four T Slots are provided for rigid grip on Drilling Machine.

Item Code No.	Size	
	Inch	mm
ABM-VC-10960	3"	80
ABM-VC-10961	4"	100
ABM-VC-10962	6"	150



Drill Machine Vice^{Super}

- Now no Tilting of Sliding Jaws.
- Can be used for light milling & Drill Works, simple but sturdy.
- Fitted with all hardened ground high quality steel jaws.
- Moving jaws is plain and other jaw is provided with one vertical & two horizontal 90° V-Grooves for better gripping.

Item Code No.	Size Inch	Jaw Width mm	Jaw Opening mm
ABM-VC-12500	4"	100	130
ABM-VC-12501	6"	150	210
ABM-VC-12502	8"	200	290

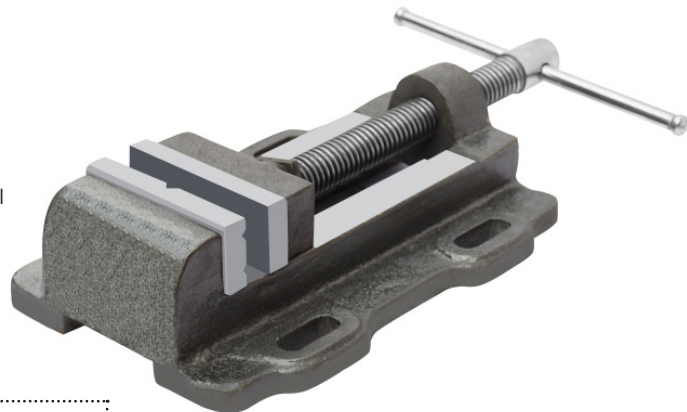

Universal Compound Vice

- Can be used on Drilling Machine for Cutting Key-ways, doing light jobs, making milling attachment for your lathe, make cross slides for your wood lathes and numerous other uses.
- Vice easily fits on any drilling machine.
- Travel bothways 125 x 150 x 175 x 150 mm.

Item Code No.	ABM-VC-11523
Size	5"
Width of Jaws	125 mm
Depth of Jaws	55 mm
Travel bothways	175 x 150 mm

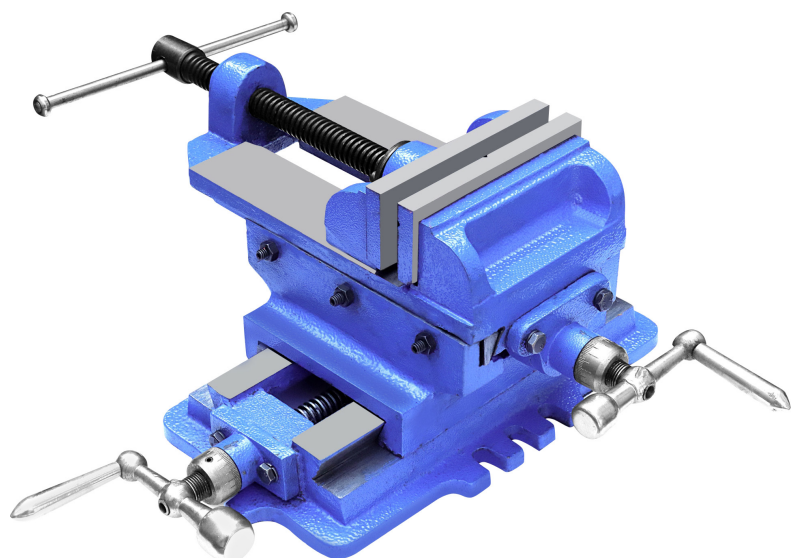

Compound Slide Vise Precision (X / Y Axis)

- Manufactured from graded cast iron.
- These vise jaws are adjustable and can hold round pieces or flat work pieces.
- Jaw are made of tool steel hardened and precision ground.

Item Code No.	Jaw Width	
	Inch	mm
ABM-VC-11520	3-3/16"	83
ABM-VC-11521	3-1/8"	80

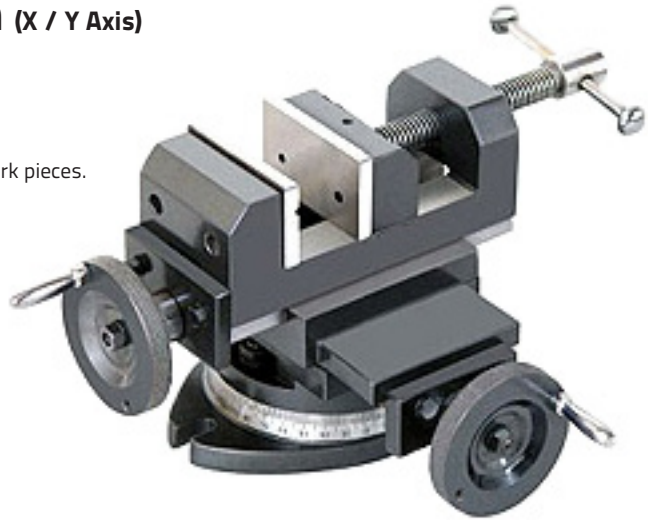

Precision Tool Makers Vise

- Manufactured from tool steel hardened 55 - 60 HRC, and high precision ground.
- Screw type Vise for clamping, releasing is through threaded spindle with precision cut square threads for smooth operation.
- Vise jaw movement is on dovetail slide for rigidity.
- Bottom of Vise can be used as a long precision Vee Block.
- This vise has multi uses.

Item Code No.	Jaw Width	
	Inch	mm
ABM-VC-10935	2-1/2"	63

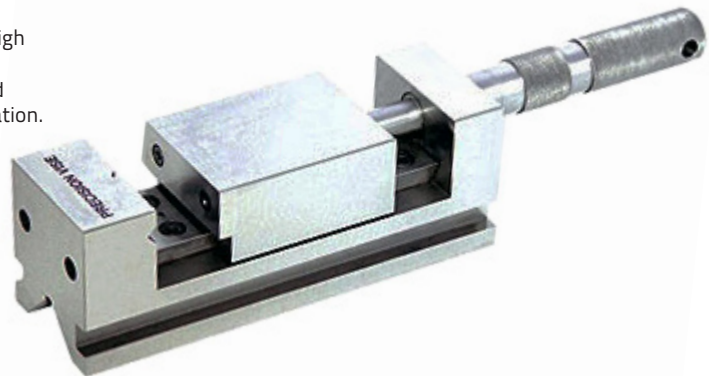

Toolmaker's Precision Screwless Vise

- Hardened and Precision Ground Steel Vise.
- Positive down load and rapid positioning notches for free Jaw movement.
- Threaded hole on both sides of stationary Jaw.
- Horizontal and Vertical V in moveable Jaw.

Item Code No.	Size	
	Inch	mm
ABM-VC-11010	1"	25
ABM-VC-11011	1-1/2"	38
ABM-VC-11012	2"	50
ABM-VC-11013	3"	75
ABM-VC-11014	4"	100
ABM-VC-11015	6"	150



Precision Grinding Vice (Tool Maker's Precision Steel Vice)

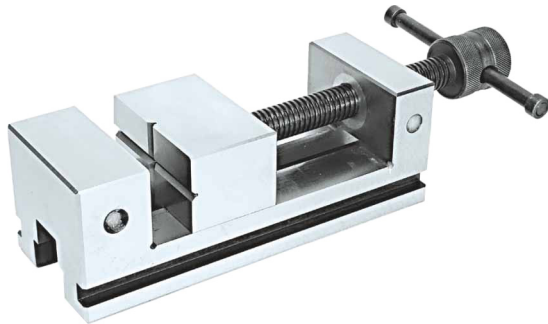

- Made from hardened alloy steel.
- Single piece construction with V-grooved Jaws.
- All surface including Jaws and Base are precise ground square and parallel.
- Clamping slots at the bottom easily affix to angle plates, etc.

Item Code No.	Size	
	Inch	mm
ABM-VC-11000	1"	25
ABM-VC-11001	2-3/8"	60
ABM-VC-11002	3"	75
ABM-VC-11003	4"	100
ABM-VC-11003	6"	100

Precision Sine Vice (Lead Screw Type)



- Manufactured from Tool Steel fully hardened 55 - 60 HRC.
- Precision ground and mounted onto a Precision hinged bottom plate.
- All the surface of vises are precisely ground for extreme accuracy.
- A minute angle step of 0.2" / 5 mm allows very small angles to be set with ease using standard gauge blocks.

Item Code No.	Jaw Width	
	Inch	mm
ABM-VC-11040	3"	75
ABM-VC-11041	4"	100

Precision Grinding Vice



- Body and Jaw of solid all steel Construction and Case hardened.
- Slotted sides provide multitude of clamping possibilities.
- Locking Screw provided at the Vice base for adjustable positions of the moveable Jaw.

Item Code No.	Size	
	Inch	mm
ABM-VC-11030	2"	50
ABM-VC-11031	2-7/8"	73

Precision Sine Vice (Screwless Type - Pin Type)

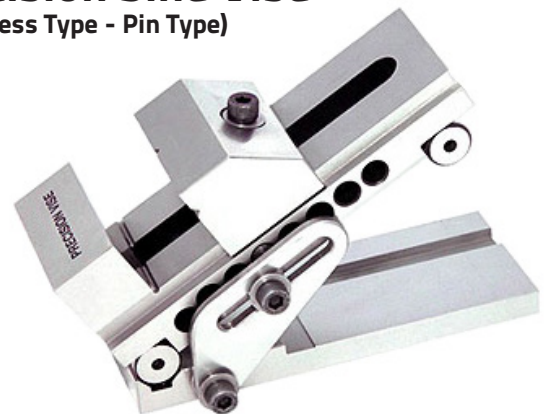

- Manufactured from Tool Steel fully hardened 55 - 60 HRC.
- Precision ground and mounted onto a Precision hinged bottom plate.
- All the surface of vises are precisely ground for extreme accuracy.
- A minute angle step of 0.2" / 5 mm allows very small angles to be set with ease using Standard Gauge Blocks.

Item Code No.	Jaw Width	
	Inch	mm
ABM-VC-11050	3"	75
ABM-VC-11051	4"	100

Work Holding Device



Magic Vices

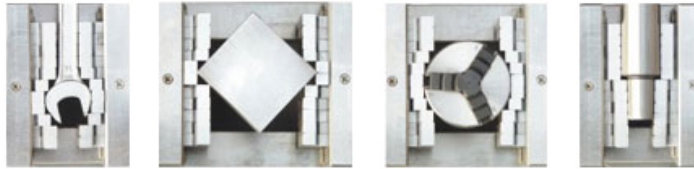

- Manufactured from close grained high tensile grade cast iron and precision ground body.
- The Vise has multiple applications and is useful for clamping polygon work pieces, circular and round jobs as well as complex pieces.
- The round parts can be gripped with superior holding power.
- This vise has the capacity of gripping odd shaped work pieces and eliminates the use of fixtures and jigs.

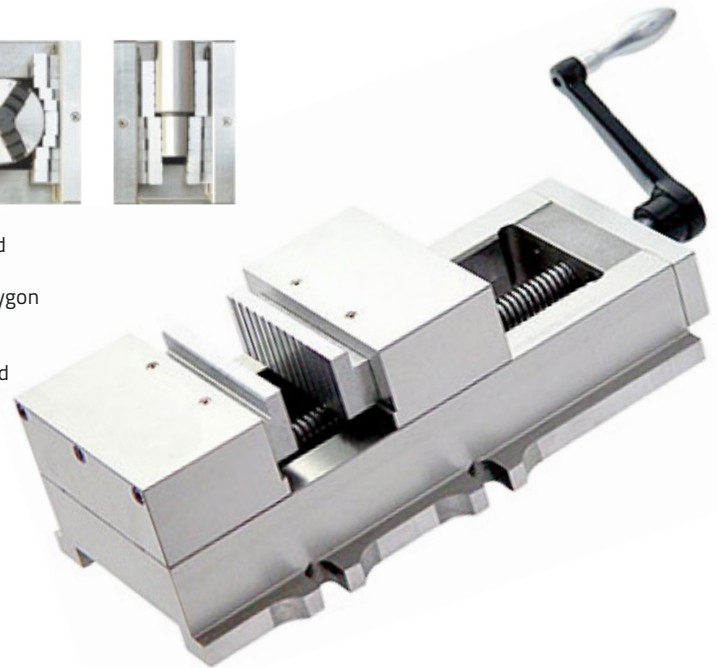

Item Code No.	Jaw Width	
	Inch	mm
ABM-VC-11070	3"	75
ABM-VC-11071	4"	100
ABM-VC-11072	5"	125

Precision Grinding Control Vise

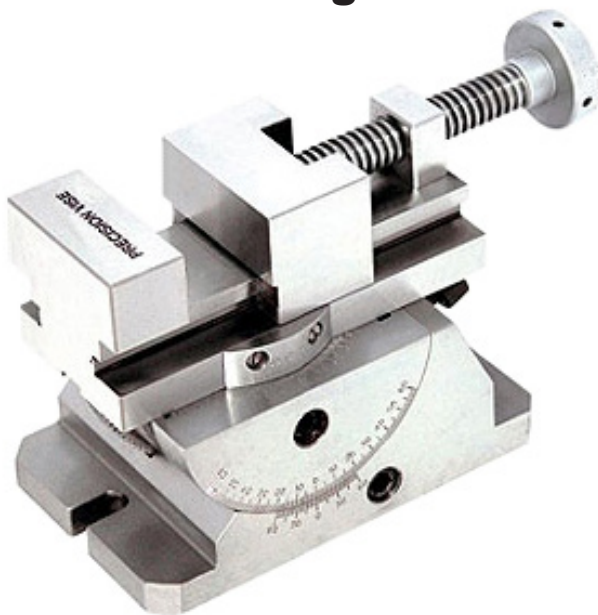

- Vise made of tool steel hardened and high precision ground 55 - 60 HRC, base is manufactured from close grained high tensile cast iron.
- Swivels on two levels 360° horizontal $\pm 45^\circ$ vertical nonious for precise minute read out.
- Screw for upward and downward swing.
- The vise is suitable for Grinding, Boring, Milling and Eroding.

Item Code No.	Jaw Width	
	Inch	mm
ABM-VC-11080	2-3/4"	70
ABM-VC-11081	4"	100

Polygon Machine Vise

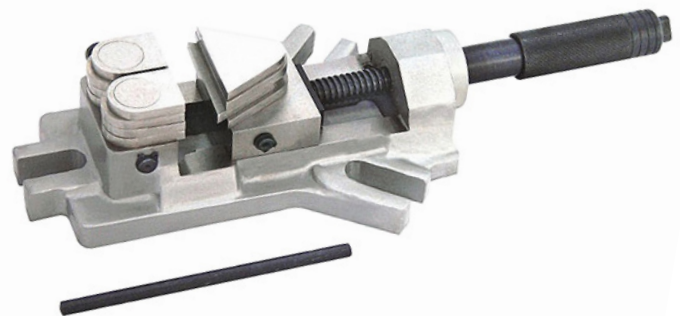

- This multipurpose machine vise is a precision accessory for CNC Milling Machine & Machining Centers, EDM, Drilling Machine.
- Combining rigid construction, Low overall height and high accuracy, this is an invaluable asset to every Machine shop.
- The body and moveable jaw are made of SG iron casting.
- The jaw plates are made of special alloy steel hardened and ground to dose tolerance.
- The screw rod and nut, which are also of alloy steel, are toughened to impart strength and resistance.
- The sliding surface are ground to ensure correct fit and high accuracy.
- Twelve moveable & sliding jaws to clamp any irregular shapes.
- Avoids fixtures cost and delay.
- 360° leaf rotation gives totally flexibility in clamping.

Item Code No.	Clamping Range	
	Inch	mm
ABM-VC-11045	0 to 3-3/8"	0 - 85
ABM-VC-11046	0 to 5"	0 - 125

Precision Mini Tilt & Swivel Base Vise



- Swivel Angle attachment is removable and can be used as a plain vise.
- Comes complete with removable jig plates for grinding and milling.

Item Code No.	Jaw Width	
	Inch	mm
ABM-VC-11055	2-3/4"	70

Hydraulic Machine Vice (Fixed Base) (Hydraulic Power)

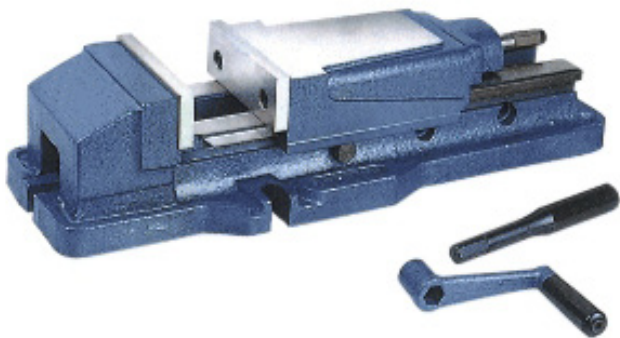

- Sliding bed ways flame hardened and ground.
- Hydra-booster system for maximum clamping pressure with minimum force.
- Body is made of high quality ductile cast iron, resists deflection or bending.
- Concealed spindle for protection against chips and dirt.
- Quick of clamping & locking and ease of operation.

Item Code No.	Width of Jaws	Depth of Jaws	Opening of Jaws
ABM-VC-11398	160 mm	56 mm	300 mm

Rotary Head Vice (Swivel Base)



Item Code No.	Size mm
ABM-VC-11390	100
ABM-VC-11391	120
ABM-VC-11392	145

Hydraulic Machine Vice (Swivel Base) (Hydraulic Power)

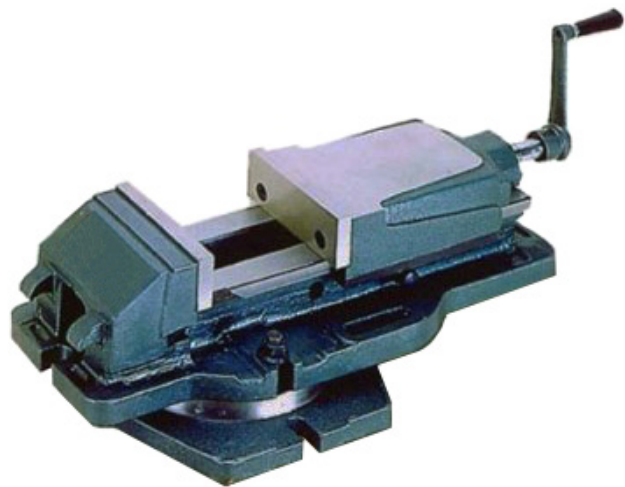

- Sliding bed ways flame hardened and ground.
- Hydra-booster system for maximum clamping pressure with minimum force.
- Body is made of high quality ductile cast iron, resists deflection or bending.
- Concealed spindle for protection against chips and dirt.
- Quick of clamping & locking and ease of operation.

Item Code No.	Width of Jaws	Depth of Jaws	Opening of Jaws
ABM-VC-11440	160 mm	56 mm	300 mm

Hydraulic Machine Vice Heavy Duty

Ductile Iron, Unbreakable Body, Hydraulic Pressure
Hardened Ground Guide Ways

- Rigid Material Vice Body of Ductile Iron for milling, drilling, shaping, grinding and many other machine shop applications.
- Lock Proof System : Prevent wrong clamping force stuck the vise.
- Clamping Force : 4000-4500 KGF.
- Sliding Bed ways hardened and ground.
- Concealed spindle for protection against chips and dirt.
- Hydraulic – Booster system for maximum clamping pressure with minimum force.
- Quick of clamping & locking and easy of operation.
- Accuracy in Squareness within 0.02/100MM.
- Furnished with or without swivel base.



Fixed Base Details

Item Code No.	ABM-VC-11445	ABM-VC-11446	ABM-VC-11447
Size in Inches	4" (100 mm)	5" (125 mm)	6" (150 mm)
Width of Jaws in mm	105	150	150
Opening of Jaws in mm	150	200	300
Depth of Jaws in mm	36	58	58
Length of Jaws in mm	440	510	620
Height Overall in mm	95	145	145
Width Overall in mm	170	230	230
Tenon Slot Size in mm	20	20	20
Weight Approx Kg.	19	48	53

Swivel Base Details

Item Code No.	ABM-VC-11450	ABM-VC-11451	ABM-VC-11452
Size in Inches	4" (100 mm)	6" (125 mm)	6" (150 mm)
Width of Jaws in mm	105	150	150
Opening of Jaws in mm	150	200	300
Depth of Jaws in mm	36	58	58
Length of Jaws in mm	440	510	620
Height Overall in mm	125	185	185
Width Overall in mm	200	300	300
Tenon Slot Size in mm	20	20	20
Weight Approx Kg.	22	60	65

Tilt Lock Machine Vice (Swivel Base) (Kurt Type)

- Tilt Lock Vices can with stand heavy jobs.
- Top & Bottom of vice bed, bottom & both sides of jaws & all jaw mounting surfaces are precision ground.
- By reversing the jaw plates the jaws are raised & can be fitted to both ends of the fixed jaws & the moveable jaws.
- The four different positions of jaw plates pair are available for more gripping area.
- Coolant through on vise body and swivel base.
- Chip clearance holes , no dead pockets.
- Swivel handle allows the screw head revolved on machine table.
- The vice can be disassembled and repaired by regrinding.
- Rigid Material Vice Body of Ductile Iron.
- Fitted with Thrust Bearing for Smooth Movement
- Tilt Lock Vices can with stand heavy jobs.
- Supplied with Stopper for Fast Production

Item Code No.	Size		Jaw Opening mm
	Inch	mm	
ABM-VC-11300	4"	100	150
ABM-VC-11301	5"	125	125
ABM-VC-11302	6"	150	150
ABM-VC-11303	6"	150	200
ABM-VC-11304	8"	200	200
ABM-VC-11305	8"	200	250
ABM-VC-11306	8"	200	300

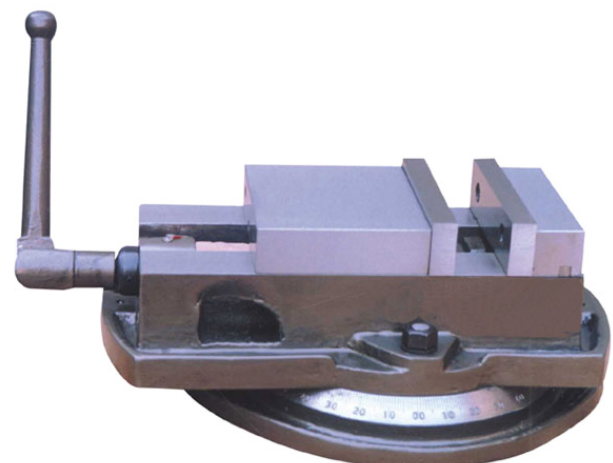

Tilt Lock Machine Vice (Fixed Base) (Kurt Type)

- Tilt Lock Vices can with stand heavy jobs.
- Top & Bottom of vice bed, bottom & both sides of jaws & all jaw mounting surfaces are precision ground.
- By reversing the jaw plates the jaws are raised & can be fitted to both ends of the fixed jaws & the moveable jaws.
- The four different positions of jaw plates pair are available for more gripping area.
- Coolant through on vise body and swivel base.
- Chip clearance holes, no dead pockets.
- The vice can be disassembled and repaired by regrinding.
- Rigid Material Vise Body of Ductile Iron.
- Fitted with Thrust Bearing for Smooth Movement.
- Tilt Lock Vices can with stand heavy jobs.
- Supplied with Stopper for Fast Production.

Item Code No.	Size		Jaw Opening mm
	Inch	mm	
ABM-VC-11310	4"	100	150
ABM-VC-11311	5"	125	125
ABM-VC-11312	6"	150	150
ABM-VC-11313	6"	150	200
ABM-VC-11314	8"	200	200
ABM-VC-11315	8"	200	250
ABM-VC-11316	8"	200	300

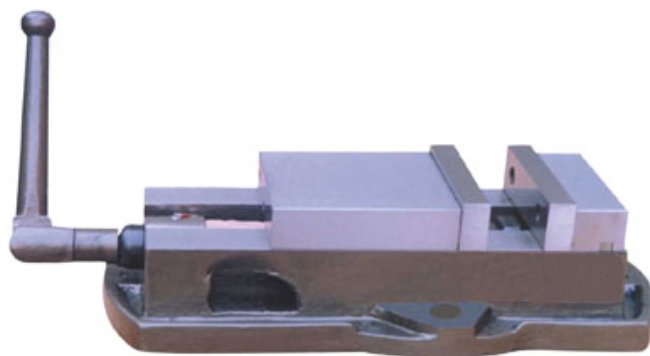

Tilt Lock Down Machine Vice

Kurt Type - Fixed Base - Precision

- This vice can be clamped vertical or either side.
- High clamping force can be achieved by effortless handle movement which eliminates hammering on handle.
- Hardened jaws maintain accuracy for long time.
- Enhanced body structure reduces the deflection in operation while the vice mounted vertical or horizontal.
- Ductile iron body.
- Sealed bearing system reduces clamping pressure and increases bearing life.
- Accuracy in parallelism & squareness within 0.02/100mm
- No work piece tilt after clamping.
- All parts are interchangeable.
- Tenon and tenon slots provided for effortless truing of vice.
- Supplied with stopper for fast production

Item Code No.	ABM-VC-11455
Size	6" (150 mm)
Width of Jaws in mm	150
Max Opening with Standard Jaw Reversed	200
Max Opening with Jaw Reversed	430
Depth of Jaws in mm	45
Overall Length in mm	515
Height Overall in mm	125
Tenon Slot Size in mm	35
Weight Approx Kg.	20

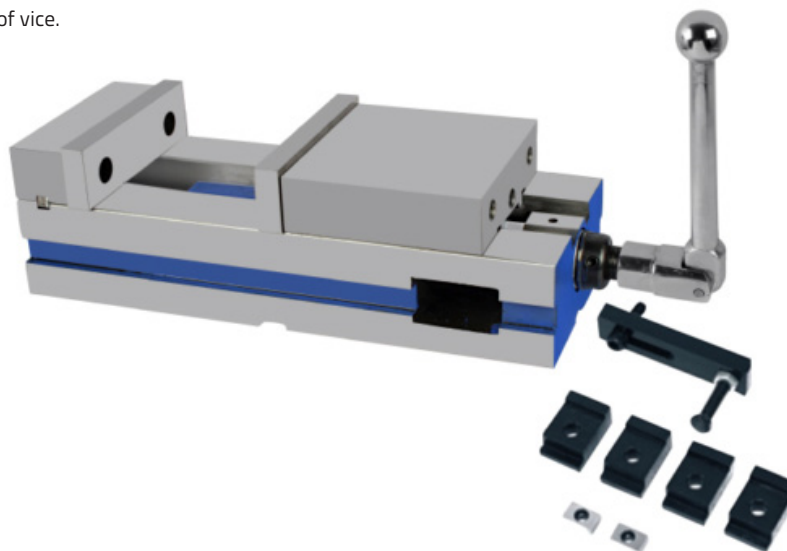

Tilt Lock Hydraulic Vice Precision

- Rigid Material Vice Body of Ductile Iron.
- Clamping Force : 4000-4500 KGF.
- Sliding Bed ways hardened and ground.
- Hydraulic- Booster system for maximum clamping pressure with minimum force.
- Down thrust Semi – Sphere segment mechanism eliminates Jaw Lifting and Work Lift.
- Quick of clamping & locking and easy of operation.
- Accuracy in Squareness within 0.02/100 MM.
- Hardened and Ground Guide Ways.

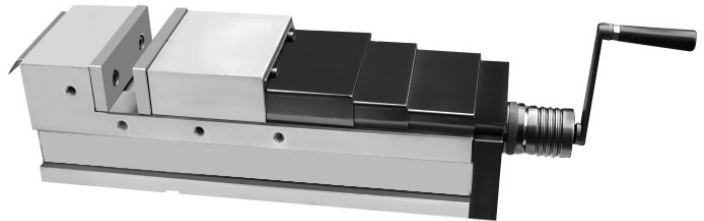

Item Code No.	ABM-VC-11320	ABM-VC-11321
Size in Inches	6" (150 mm)	6" (150 mm)
Width of Jaws in mm	160	160
Opening of Jaws in mm	200	300
Depth of Jaws in mm	58	58
Overall Length in mm	520	710
Height Overall in mm	165	165
Width Overall in mm	160	160
Tenon Slot Size in mm	20	20
Weight Approx Kg.	50	60

Tilt Lock Down Self Centering Vice

ANGLE LOCK SELF CENTERING VICE

- This vice can be clamped vertical or either side.
- High clamping force can be achieve by effortless.
- Handle movement which eliminates hammering on handle.
- Hardened jaws maintain accuracy for long time.
- Enhanced body Structure reduces the deflection in operation while the vice mounted vertical or horizontal.
- Ductile iron body.
- Sealed bearing system reduces clamping pressure and increases bearing life.
- Accuracy in parallelism & squareness with in 0.02/100mm
- No work piece tilt after clamping.
- All parts are interchangeable.
- Tenon and tenon slots provided for effortless truing of vice.
- Supplied with stopper for fast production.
- Unbreakable Body

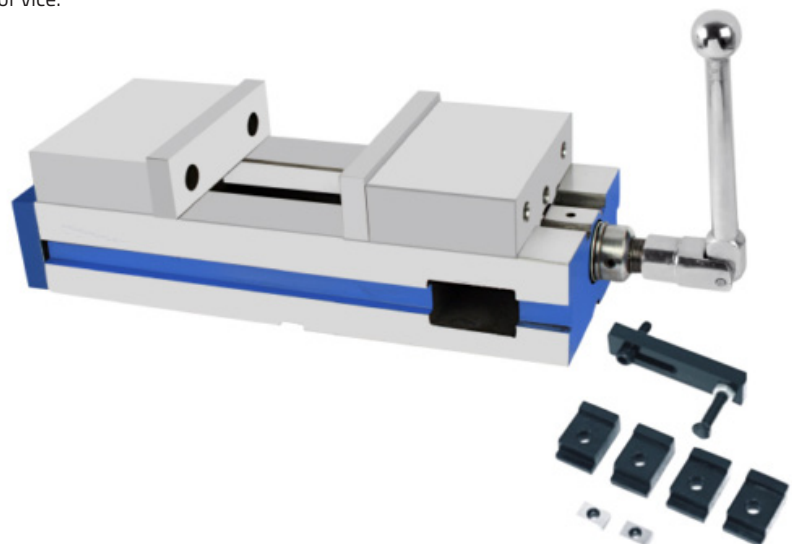

Item Code No.	ABM-VC-11296
Size	6" (150 mm)
Width of Jaws in mm	150
Max Opening with Standard Jaw Reversed	200
Max Opening with Jaw Reversed	430
Depth of Jaws in mm	45
Overall Length in mm	490
Height Overall in mm	125
Tenon Slot Size in mm	20
Weight Approx Kg.	36

Precision Quick Setting Machine Vice

- High Quality Alloy Steel.
- Conventional and CNC controlled milling machines-for efficient precision machining.
- Horizontal installation – great variability and flexibility.
- Excellent ease of operation guarantees optimal handling for every application.
- Fast adjustment for clamping range presetting.
- Accuracy in Squareness within 0.02/100MM.
- Fixing on the machine table by means of mounting holes in the vice base.
- Optional center jaw allows two or more workpieces to be clamped.
- Hardness 60+ HRC

Item Code No.	ABM-VC-11325
Size in Inches	6" (150 mm)
Width of Jaws in mm	160
Opening of Jaws in mm	255
Depth of Jaws in mm	48
Overall Length in mm	485
Height Overall in mm	105
Width Overall in mm	150
Tenon Slot Size in mm	20
Weight Approx Kg.	27

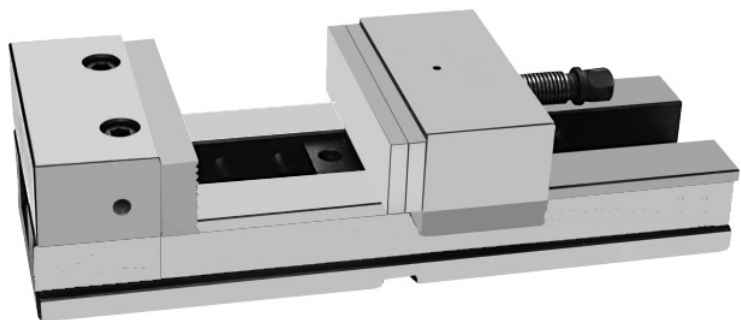

Dual Station Vice

Precision

- Rigid Material Vice Body of Ductile Iron.
- Clamping force equalization same force to two workpiece in different size.
- Anti-lift mechanism ensure the workpiece does not lift during operation.
- Double clamp makes different size of workpieces can be clamped at the same time.
- Can be mounted Horizontally or Vertically.
- Fixed Center Jaw has a Machined Keyway for Accurate.
- Alignment and Setup.
- 5 Different Workpiece Clamping Applications.
- Accuracy in Squareness within 0.02/100 MM.
- Hardened and Ground Guide Way.

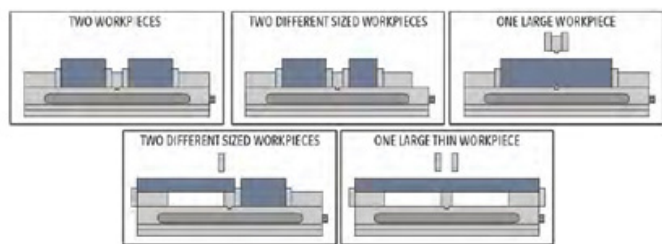

Item Code No.	ABM-VC-11205
Size in Inches	6" (150 mm)
Width of Jaws in mm	152
Opening of Jaws each size in mm	0-125
Max Opening in mm	0 - 310
Depth of Jaws in mm	45
Overall Length in mm	520
Height Overall in mm	127
Width Overall in mm	150
Tenon Slot Size in mm	20
Weight Approx Kg.	50

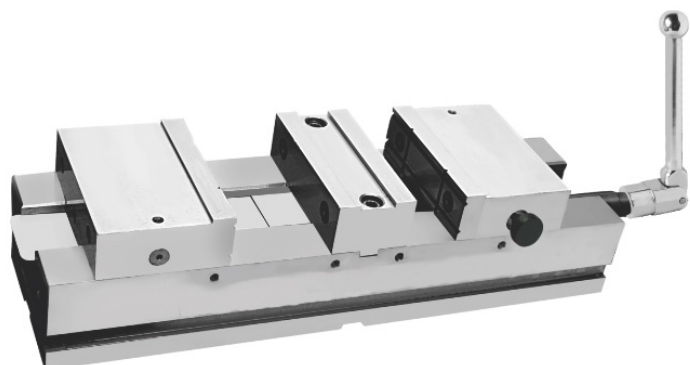

Precision Tilt Lock Down Machine Vice

Kurt Type - Fixed Base - Rear Jaws

- Top & Bottom of vice bed, bottom & both sides of jaws & all jaw mounting surfaces are precision ground.
- By reversing the jaw plates the jaws are raised & can be fitted to both ends of the fixed jaws & the moveable jaws.
- The four different positions of jaw plates pair are available for more gripping area.
- Rigid Material Vice Body of Ductile Iron.
- It is Fitted with Thrust Bearing for Smooth Movement.
- This Tilt Lock Vices can with stand heavy jobs.
- Coolant through on vise body and swivel base.
- Chip clearance holes, no dead pockets.
- Swivel handle allows the screw head revolved on machine table.
- The vice can be disassembled and repaired by regrinding.
- Supplied with Stopper for Fast Production.

Item Code No.	ABM-VC-11017
Width of Jaws	70 mm
Length Overall	540 mm
Height Overall	110 mm
Tenon Slot Size	12 mm
Weight Approx	22 Kg.

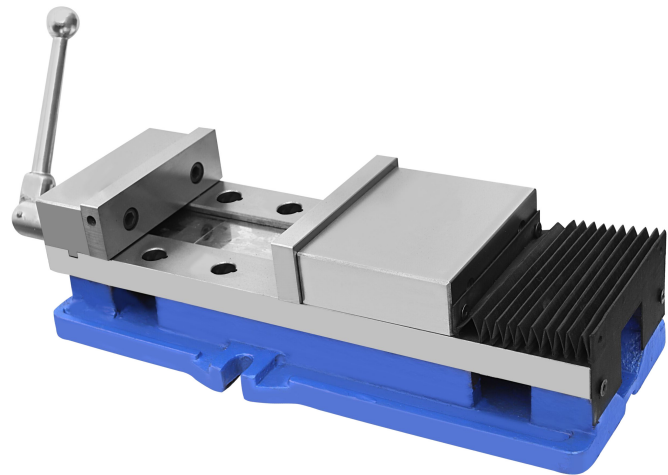

Modular Precision Machine Vice

With Parallel Top Jaws

- Case Hardened HRC 60 ±2 TO give maximum rigidity, high performance & no wear .
- Both Jaws plates are in pull-down angle ,this ensures anti-lift clamping of the workpiece .
- Made from High Quality Alloy Steel
- Accuracy in Squareness 0.01/100 MM
- It Can be used in multiple style.
- It is Low Profile.
- Supplied with stopper for fast Production.

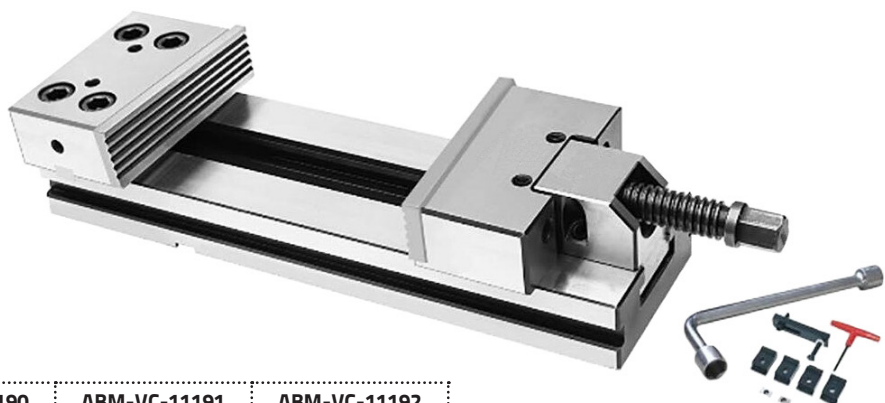

Item Code No.	ABM-VC-11190	ABM-VC-11191	ABM-VC-11192
Size	4" (100 mm)	6" (150 mm)	8" (200 mm)
Width of Jaws in mm	100	150	200
Opening of Jaws mm	130	200	300
Depth of Jaws in mm	30	50	60
Overall Length in mm	325	420	555
Height Overall in mm	71	98	118
Width Overall in mm	102	150	203
Tenon Slot Size in mm	16	16	16
Weight Approx Kg.	10	26	50

Precision High Grip Shaft Vice Self Centering

- Precision High Grip Self Centering Shaft Vices are compact, rigid & specially designed for Accurate Centering of Round Jobs on Precision Milling Machines & CNC Operations.
- High Quality Alloy Steel, Case Hardened HRC 60 ± 2 clamping jaws for high performance & longer life without wear.
- Tenon & tenon slots are provided for effortless truing on the vice of the machine table.
- Smooth & effortless handle movement to achieve high clamping force without hammering.
- Made from Unbreakable High Strength Ductile Iron Body.
- Grounded Top & Bottom.
- Perfectly designed vice for rigid gripping & mass production.

Item Code No.	ABM-VC-11260	ABM-VC-11261
Size in Inches	6"	6"
Width of Jaws in mm	150	150
Holding Capacity Standard Jaws in mm	40-100	50-150
Holding Capacity Reverse Jaws in mm	20-40	30-50
Length Overall in mm	320	500
Height Overall in mm	150	205
Tenon Slot Size in mm	20	20
Weight Approx Kg.	28	56

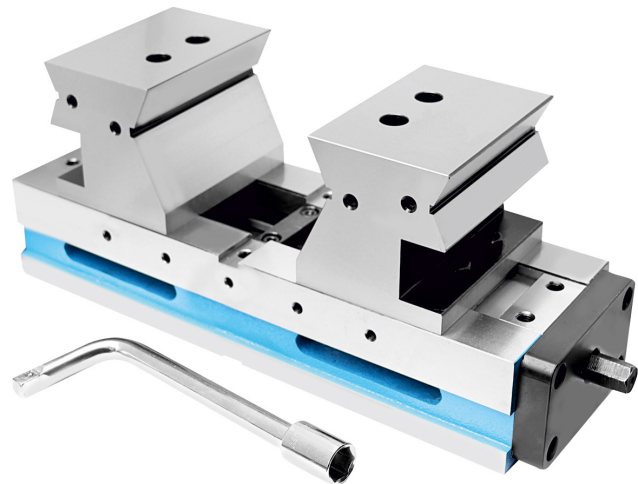

Precision Multi Grip Machine Vice Serrated Slide Ways

- Precision Multi Grip Machine Vices are compact, rigid & specially designed for clamping multiple workpieces of various sizes.
- The use of Multi Grip Vice maximizes the machine table capacity and helps to increase productivity.
- The system is compact & reliable for holding multiple workpieces at the same time thereby reducing tool changeover times.
- Vice Body & Accessories are of High Quality Alloy Steel, Case Hardened HRC 60 ± 2 for maximum rigidity, high performance & longer life without wear.
- Have Precise accuracy in positioning and alignment ± 0.02 mm.
- It is Supplied with 3 fixed jaws & two wedge clamps.

Item Code No.	ABM-VC-11017
Width of Jaws in mm	70
Overall Length in mm	540
Height Overall in mm	110
Tenon Slot Size in mm	12
Weight Approx Kg.	22

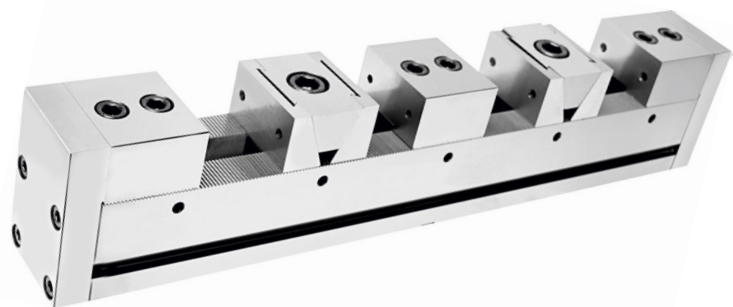

Wedge Clamp

Used for Precision Multi Grip Machine Vice - Serrated Slide Ways

- These wedge clamps are ideal for multiple clamping operations as well clamping individual work pieces.
- Wedge Clamp Clamping provides consistent accurate clamping force through socket head cap screw by moving both jaws outward.
- Hidden springs eliminate clogging of chips.
- Hardened & Ground Wedge surfaces with hi-Tensile socket head cap screw.
- Serrated Jaw faces are also available.

Item Code No.	ABM-VC-11020	ABM-VC-11021	ABM-VC-11022
Width of Jaws mm	50	60	70
T Nut mm	12	14	16



Precision Self Centering Vice 5 Axis

- High alloyed quality resistance steel, case hardened upto HRC 60 \pm 2 all body and accessories of vice give maximum rigidity, high performance.
- Compatible for 4th & 5th CNC Machine Centres.
- Accuracy in squareness 0.01/100 MM

Item Code No.	ABM-VC-11308	ABM-VC-11309
Size in Inches	4"	6"
Width of Jaws in mm	100	150
Opening of Jaws in mm	150	175

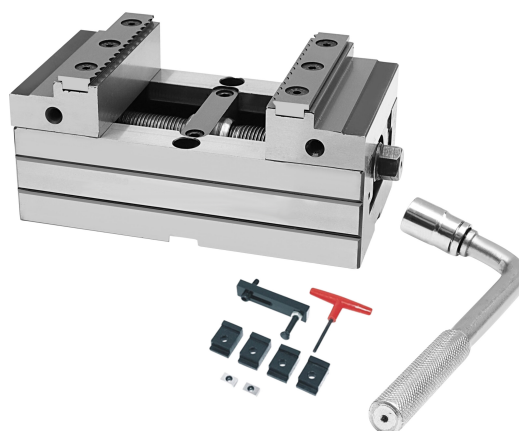

Precision High Grip Machine Vice

- Precision High Grip Machine Vices are compact, rigid & specially designed for Precision Milling, Grinding & CNC Operations.
- High-Quality Alloy Steel, Case Hardened HRC 60 \pm 2 clamping jaws for high performance & longer life.
- Tenon & tenon slots are provided for effortless truing of vice on the machine table.
- Smooth & effortless handle movement to achieve high clamping force. (Max 5000 Kg.)
- Unbreakable High Strength Ductile Iron Body.
- Grounded Top & Bottom.
- Accuracy in parallelism & squareness within 0.02 / 100 mm.
- Interchangeable Jaw Plates are also available.

Item Code No.	ABM-VC-11060	ABM-VC-11061
Size in Inches	6"	6"
Width of Jaws in mm	150	150
Opening of Jaws in mm	250	380
Length of Jaws in mm	360	530
Height Overall in mm	113	130
Tenon Slot Size in mm	20	20
Weight Approx Kg.	22	38

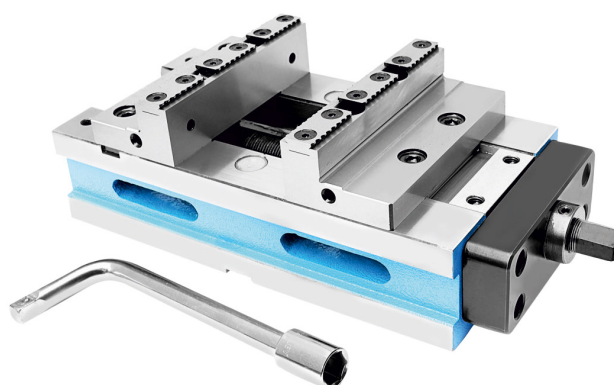

Precision High Grip Machine Vice Self Centering

- Precision Self Centering High Grip Machine Vices are compact, rigid & specially designed for Precision Milling, Grinding & CNC Operations.
- High Quality Alloy Steel, Case Hardened HRC 60 \pm 2 clamping jaws for high performance & longer life without wear.
- It comes with Tenon & tenon slots for effortless truing on the vice of the machine table.
- It has a Compact Design with large opening suitable for 4th & 5th Axis Rotary Tables.
- Smooth & effortless handle movement to achieve high clamping force. (Max: 3000 Kg.)
- This Vice is suitable for holding two workpieces with an optional intermediate jaw.
- Made from Unbreakable High Strength Ductile Iron Body.
- It has Grounded Top & Bottom.
- Accuracy in parallelism & squareness within 0.02 / 100 mm.
- Interchangeable Jaw Plates are also available.

Item Code No.	ABM-VC-11570	ABM-VC-11571
Size in Inches	6"	6"
Width of Jaws in mm	150	150
Opening of Jaws in mm	250	380
Length of Jaws in mm	320	500
Height Overall in mm	113	130
Tenon Slot Size in mm	20	20
Weight Approx Kg.	20	40



Modular Precision Milling Vice

- High Quality Alloy Steel.
- Accuracy In Squareness 0.01 / 100 mm
- Case Hardened HRC 60 ±2 To Give Maximum Rigidity, High Performance & No Wear.
- Can Be Used Multiple Style.
- Both Jaws Plates Are In Pull-Down Angle.
- This Ensures Anti-Lift Clamping Of The Workpiece.
- Low Profile.
- Supplied With Stopper For Fast Production

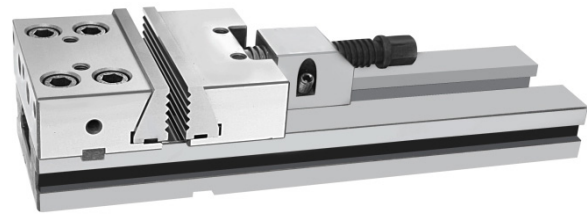
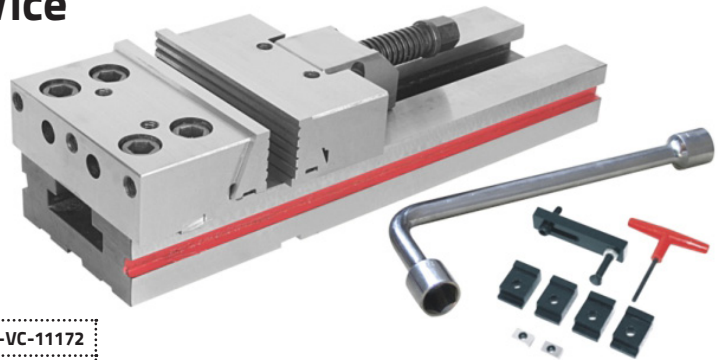

Item Code No.	ABM-VC-11170	ABM-VC-11171	ABM-VC-11172
Size in Inches	4" (100 mm)	6" (150 mm)	8" (200 mm)
Width of Jaws in mm	100	150	200
Opening of Jaws in mm	130	225	300
Depth of Jaws in mm	30	50	60
Overall Length in mm	325	420	555
Height Overall in mm	71	98	118
Width Overall in mm	102	150	230
Tenon Slot Size in mm	16	16	16
Weight Approx Kg.	9	28	48

Two Piece Modular Precision Milling Vice

- High alloyed quality resistance steel, case hardened HRC 60 ±2 is used in all body and accessories of vice to give maximum rigidity, high performance & no wear.
- Two Piece Modular Vice designed for precision milling used with CNC Machines.
- Accuracy in squareness 0.01 / 100 MM.
- Unlimited Clamping Range as per Workpiece.
- Both jaws plates are in pull-down angle. This ensures Anti-Lift Clamping of the Workpiece.



Item Code No.	ABM-VC-11168
Size in Inches	6" (150 mm)
Width of Jaws in mm	150
Opening of Jaws in mm	As per job
Depth of Jaws in mm	50
Overall Length in mm	Assorted
Height Overall in mm	100
Width Overall in mm	150
Tenon Slot Size in mm	16
Weight Approx Kg.	26

2 Pc Milling Machine Vice

- Body made of high quality Casting.
- Hardened and Ground Jaw Plates.
- Designed to handle extra long work piece, thus utilizing full length of machine bed.
- Work locates directly on bed for extra rigidity.
- Quarter turn of detachable handle clamps work firm enough for heaviest cuts.

Item Code No.	Size	
	Inch	mm
ABM-VC-11160	6"	150
ABM-VC-11161	8"	200

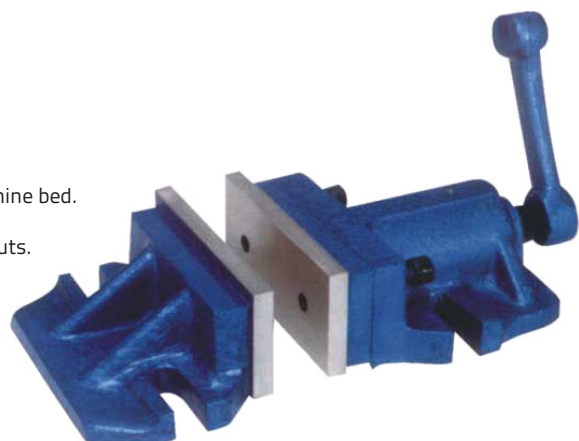

Precision Machine Vice Fixed Base - Heavy Duty

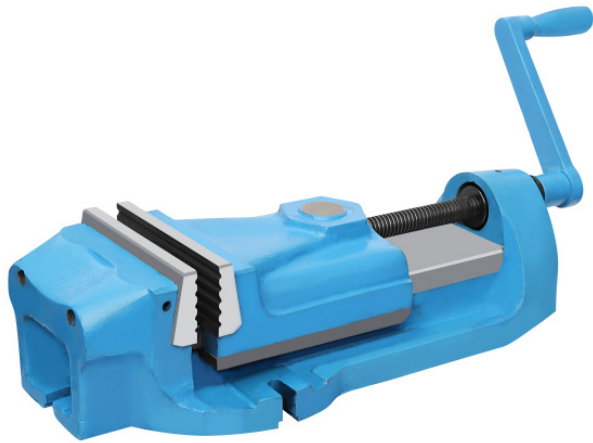

- Rigid Material Vice Body of Ductile Iron (Unbreakable Body).
- Both jaws plates are in pull-down angle.
- This ensures Anti-Lift Clamping of the Workpiece.
- Trouble Free Performance.
- Accuracy in squareness within 0.02/100 MM
- Jaw Plates are made out of Tool Steel (45-50 HRC).
- Hardened & Ground Guide Ways.

Item Code No.	ABM-VC-11150
Size in Inches	6" (150 mm)
Width of Jaws in mm	165
Opening of Jaws in mm	150
Depth of Jaws in mm	56
Overall Length in mm	550
Height Overall in mm	135
Width Overall in mm	230
Tenon Slot Size in mm	20
Width of Slot for Clamping	14
Weight Approx Kg.	43

Precision Machine Vice Swivel Base - Heavy Duty



- Rigid Material Vice Body of Ductile Iron (Unbreakable Body).
- Both jaws plates are in pull-down angle.
- This ensures Anti-Lift Clamping of the Workpiece.
- Trouble Free Performance.
- Accuracy in squareness within 0.02/100 MM
- Jaw Plates are made out of Tool Steel (45-50 HRC).
- Hardened & Ground Guide Ways.

Item Code No.	ABM-VC-11155
Size in Inches	6" (150 mm)
Width of Jaws in mm	165
Opening of Jaws in mm	150
Depth of Jaws in mm	56
Overall Length in mm	550
Height Overall in mm	175
Width Overall in mm	270
Tenon Slot Size in mm	20
Width of Slot for Clamping	14
Weight Approx Kg.	54

Precision Machine Vice (Swivel Base)

- Designed for high accuracy.
- Minimum vibration.
- Low height with rigidity

Item Code No.	Size	
	Inch	mm
ABM-VC-11250	4"	100
ABM-VC-11251	6"	150

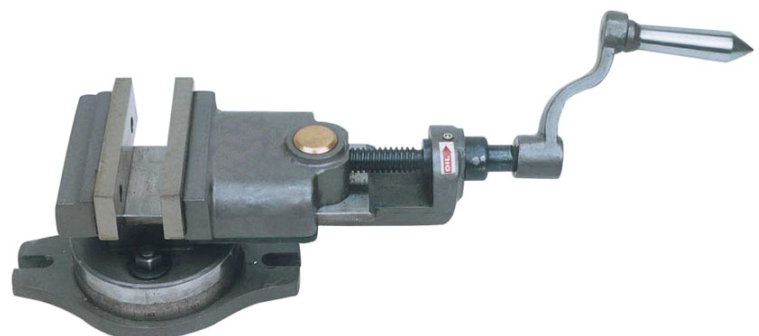

Self Centering Vice (Fixed Base)



- Body made out of special graded casting.
- Hardened steel jaws provided 'V' grooves for round jobs both Horizontal and Vertically.
- Special steel screw is provided for long life.

Item Code No.	Size	
	Inch	mm
ABM-VC-11110	2"	50
ABM-VC-11111	3"	75
ABM-VC-11112	4"	100

Unigrip Machine Vice (Heavy Duty - Precision)

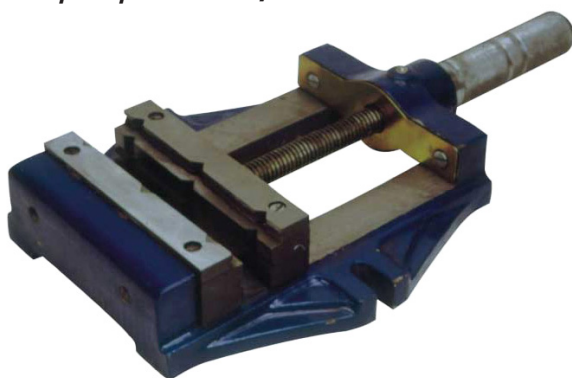

- Recommended Vice for use on Drill Presses, Milling Machines and Grinders.
- Ground base and Vice bed for extreme accuracy.
- Fixed Jaw is grooved Horizontally and Vertically for convenience in holding round pieces.
- Hardened and ground Jaw Plates.

Item Code No.	Size	
	Inch	mm
ABM-VC-11090	3"	75
ABM-VC-11091	4"	100
ABM-VC-11092	5"	125
ABM-VC-11093	6"	150

Self Centring Vice Precision

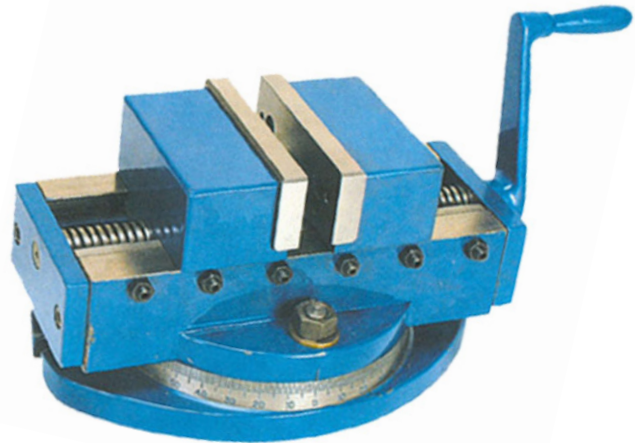

- Body made out of special graded casting.
- Hardened steel jaws provided 'V' grooves for round jobs both Horizontal and Vertically.
- Special steel screw is provided for long life.
- Swivel base to rotate 360° Degree.
- Ideal for milling structural tubing of different diameters.
- Includes a sturdy lip along both sides of the base, allowing vise to be mounted to nearly any machine table, using common T-slot clamps.

Item Code No.	Size	
	Inch	mm
ABM-VC-11135	4"	100
ABM-VC-11136	6"	150

Self Centering Vice (Swivel Base)

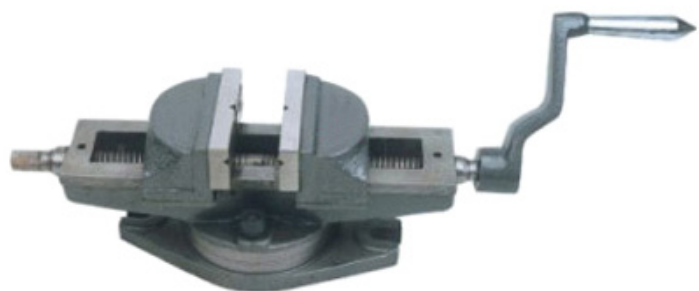

- Body made out of special graded casting.
- Hardened steel jaws provided 'V' grooves for round jobs both Horizontal and Vertically.
- Special steel screw is provided for long life.
- Swivel base to rotate 360° Degree.

Item Code No.	Size	
	Inch	mm
ABM-VC-11100	3"	75
ABM-VC-11101	4"	100
ABM-VC-11102	6"	150

Milling Machine Vice (Fixed Base)



- Vice body of high tensile, closed grain Cast Iron.
- Hardened and ground Jaw Plates.
- Totally enclosed acme screw.
- Low base design for use on drilling, Milling and Shaping Machine.
- Available in Cast Iron and SG Iron.

Item Code No.	Size	
	Inch	mm
ABM-VC-11120	2"	50
ABM-VC-11121	3"	75
ABM-VC-11122	4"	100
ABM-VC-11123	5"	125
ABM-VC-11124	6"	150
ABM-VC-11125	8"	200
ABM-VC-11126	10"	250
ABM-VC-11127	12"	300

Milling Machine Vice (Swivel Base) (Heavy Duty)

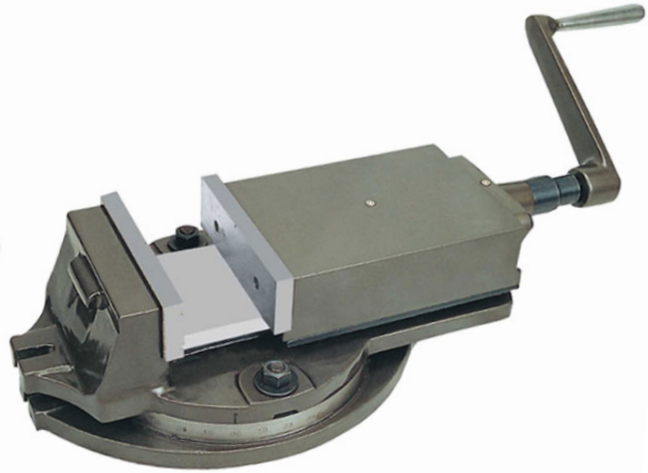

- Vice body of high tensile, closed grain Cast Iron.
- Hardened and ground Jaw Plates.
- Swivel base graduated 360° for horizontal indexing.
- Totally enclosed acme screw.
- Low base design for use on drilling, Milling and Shaping Machine.
- Available in Cast Iron and SG Iron.

Item Code No.	Size	
	Inch	mm
ABM-VC-11140	2"	50
ABM-VC-11141	3"	75
ABM-VC-11142	4"	100
ABM-VC-11143	5"	125
ABM-VC-11144	6"	150
ABM-VC-11145	8"	200
ABM-VC-11146	10"	250
ABM-VC-11147	12"	300

Tilting & Swiveling Vice (J & S Type, England Type) (Precision)

- Acme Thread screw, Steel nut, body and base are of graded C.I casting.
- Jaw are made of special carbon Steel Properly Heat Treated, Fixed jaw is provided with one vertical & two horizontal V groove to hold the round jobs firmly.
- Once Lock impossible to shift.
- The Swivel base is graduated fully 360 degree
- Vertical Tilting movement 90 degree
- Tenon Slot Machined in back as standard for CNC

Item Code No.	Size	
	Inch	mm
ABM-VC-11179	4"	100
ABM-VC-11180	6"	150
ABM-VC-11181	8"	200

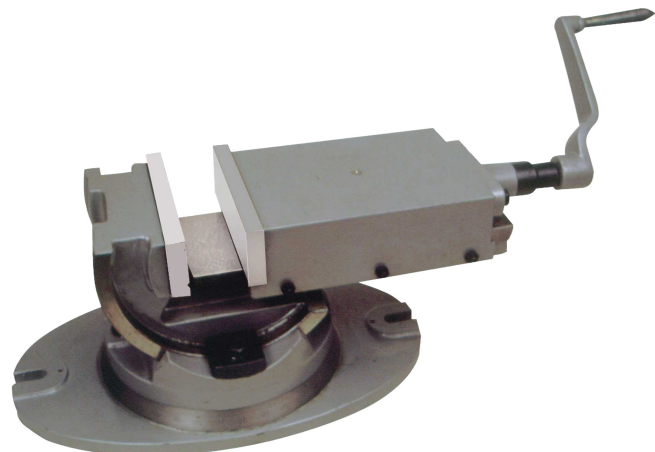

Milling Machine Vice (Fixed Base) (J & S Type, England Type) (Precision)

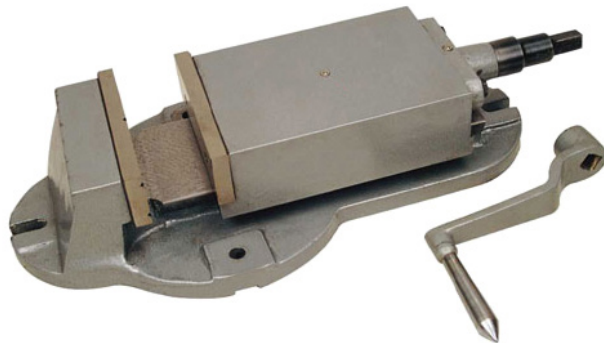

- Body and base are made of special high strength fine-grain Cast iron for toughness and rigidity.
- Moving Jaw run in long Prismatic slides with provision for wear adjustment.
- The removable hardened steel Jaws.
- Fix jaw provided with 'V' grooves.
- The totally enclosed acme thread adjusting screw with a replaceable screw bushing & thrust collar.
- The vice can be fitted to the tool table with or without the 360° graduated base.
- The vice can be centered using longitude tenon slots.
- Supplied complete with handle.
- Crank handle is made of unbreakable steel provided with a spring loaded mechanism providing positive grip.

Item Code No.	Size	
	Inch	mm
ABM-VC-11200	4"	100
ABM-VC-11201	6"	150
ABM-VC-11202	8"	200

Milling Machine Vice (Swivel Base) (J & S Type, England Type) (Precision)

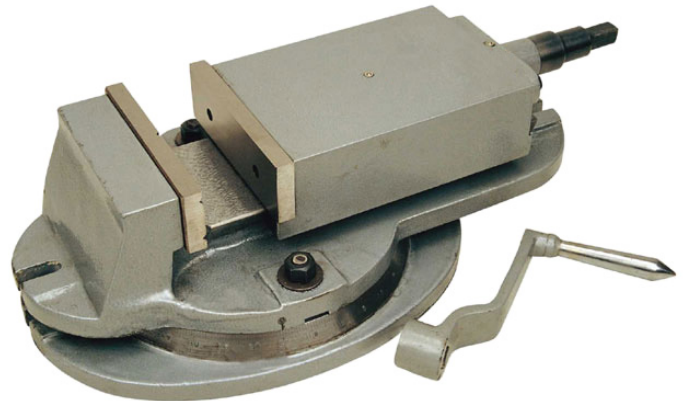

- Body and base are made of special high strength fine-grain Cast iron for toughness and rigidity.
- Moving Jaw run in long Prismatic slides with provision for wear adjustment.
- The removable hardened steel Jaws.
- Fix jaw provided with 'V' grooves.
- The totally enclosed acme thread adjusting screw with a replaceable screw bushing & thrust collar.
- The vice can be fitted to the tool table with or without the 360° graduated base.
- The vice can be centered using longitude tenon slots. Supplied complete with handle.
- Crank handle is made of unbreakable steel provided with a spring loaded mechanism providing positive grip.

Item Code No.	Size	
	Inch	mm
ABM-VC-11210	4"	100
ABM-VC-11211	6"	150
ABM-VC-11212	8"	200

Universal Vice (Universal Machine Vice)

- Vice Body made of High Grade Casting.
- Specially designed for surface grinders and Universal tool and Cutter grinders.
- Workpiece can be positively locked on hardened Jaws, at any compound Angle.
- Indexing can be done through three different graduated axis.

Item Code No.	Size	
	Inch	mm
ABM-VC-11290	2"	50
ABM-VC-11291	3"	75
ABM-VC-11292	4"	100
ABM-VC-11293	6"	150

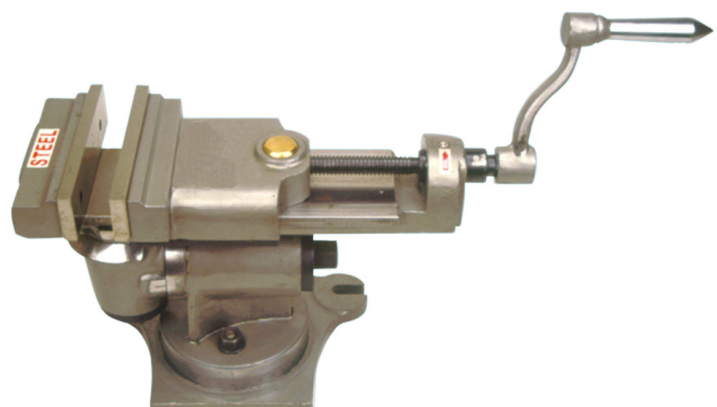

2 Way Universal Tilting & Swiveling Angle Vice (Machine Vice)

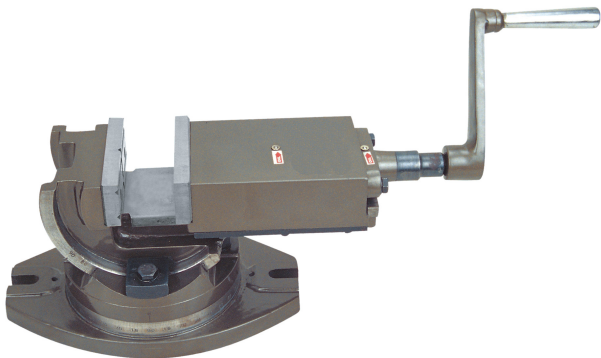

- Vice Body made of High tensile closed grain cast iron.
- Steel jaws plates are ground and hardened to 50-60 HRC.
- Base can be swiveled through 360 degree and Vice Tilted through 90 Degree.
- Vice can be locked Positively at various Compound Angles.
- Two oil Holes provided on Vice Body.
- Ideal Vice for Milling, Grinding, Shaping, Drilling and Jig Boring.

Item Code No.	Size	
	Inch	mm
ABM-VC-11240	2"	50
ABM-VC-11241	3"	75
ABM-VC-11242	4"	100
ABM-VC-11243	5"	125
ABM-VC-11244	6"	150
ABM-VC-11245	8"	200

Compound Sliding Table (Milling and Drilling Table) (With Calibrated Wheel and Swivel Base)

- Low silhouette table for light work.
- Widely spaced, Graduation for Fast, Accurate Reading.
- Easy to set.
- With Calibrated Wheel and Swivel Graduated Base.

Item Code No.	Table Size	
	Inch	mm
ABM-VC-11460	4 x 4	100 x 100
ABM-VC-11461	6 x 6	150 x 150
ABM-VC-11462	8 x 8	200 x 200
ABM-VC-11463	10 x 10	250 x 250
ABM-VC-11464	12 x 6	300 x 150
ABM-VC-11465	12 x 8	300 x 200
ABM-VC-11466	12 x 12	300 x 300

3 Way Universal Tilting & Swiveling Angle Vice (Machine Vice)

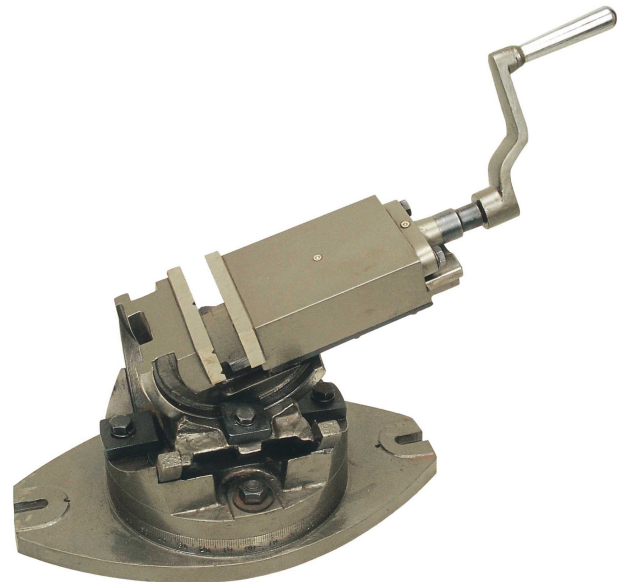

- Vice Body made of High tensile close grain Cast Iron.
- Jaw Plates are ground and Hardened to 50-60 HRC.
- Swivel Range 360° around Base.
- Tilting range 90° vertical to Horizontal and 45° from center to each side.
- Vice top surface is ground accurately to facilitate use of magnetic tool holders and other accessories.

Item Code No.	Size	
	Inch	mm
ABM-VC-11270	2"	50
ABM-VC-11271	3"	75
ABM-VC-11272	4"	100
ABM-VC-11273	6"	150

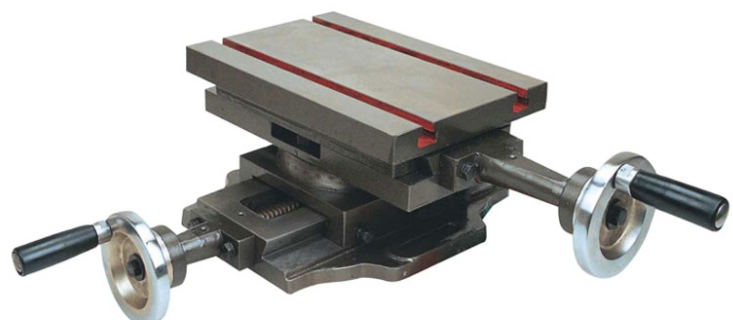

Item Code No.	Table Size	
	Inch	mm
ABM-VC-11467	12 x 20	300 x 500
ABM-VC-11468	16 x 16	400 x 400

Bigger Sizes also available on Request

Shaper Vice (Fixed Base)

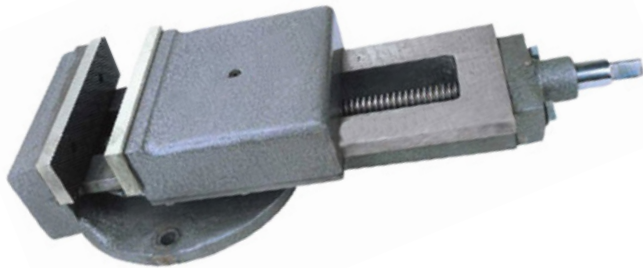

- Heavy duty shaper Vice sturdy constructed from loose grain casting for use on shaper machines, planners & other heavy duty machines permitting wider application for taller work pieces.
- It is designed to permit maximum opening jaws to hold heavy & taller jobs.
- High Tensile Steel Square Thread Screw.
- The Jaws are made of Special Steels.
- These are precisely ground & Serrated to ensure firm grips on heavy jobs.
- Crank Handle is made of unbreakable steel, provided with a spring loaded mechanism providing positive grip.

Item Code No.	Size	
	Inch	mm
ABM-VC-11330	6"	150
ABM-VC-11331	8"	200
ABM-VC-11332	10"	250
ABM-VC-11333	12"	300
ABM-VC-11334	16"	400

Shaper Vice (Swivel Base)

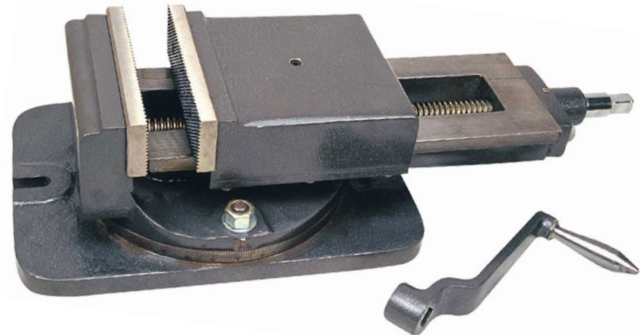

- Heavy duty shaper Vice sturdy constructed from loose grain casting for use on shaper machines, planners & other heavy duty machines permitting wider application for taller work pieces.
- It is designed to permit maximum opening jaws to hold heavy & taller jobs.
- High Tensile Steel Square Thread Screw.
- The Jaws are made of Special Steels.
- These are precisely ground & Serrated to ensure firm grips on heavy jobs.
- Swivel Base is indexed to 360 Degree, when required to use as stationary Vice, the base can be removed.
- Crank Handle is made of unbreakable steel, provided with a spring loaded mechanism providing positive grip.

Item Code No.	Size	
	Inch	mm
ABM-VC-11360	6"	150
ABM-VC-11361	8"	200
ABM-VC-11362	10"	250
ABM-VC-11363	12"	300
ABM-VC-11364	16"	400

Universal Dividing Head

- Dividing heads are carefully designed for tool Rooms as well as for production purpose.
- They are suitable for indirect and differential indexing as well as for spiral and cam milling operations on universal milling machine.
- These dividing heads are manufactured from Selected high quality material with Superior workmanship.

Item Code No.	ABM-VC-11346
Size Inches	8"
A in mm	359
B in mm	340
H in mm	235
I in mm	20
a in mm	212
b in mm	135
g in mm	16
h in mm	134
Taper of Center	MT-4
Spindle Through Hole	25



Universal Dividing Head (Complete with Gear Head)

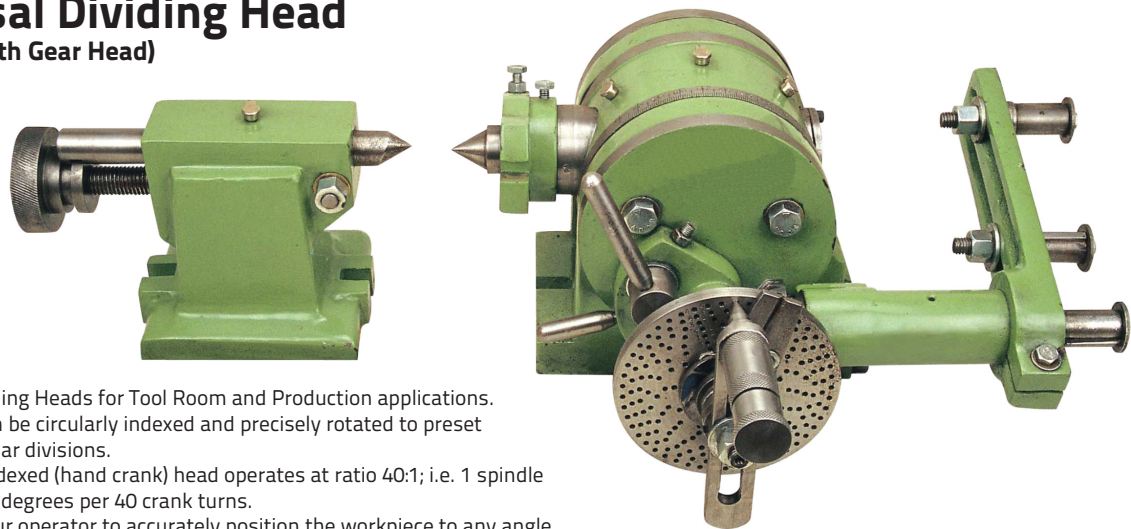

- Universal Dividing Heads for Tool Room and Production applications.
- Work piece can be circularly indexed and precisely rotated to preset angles or circular divisions.
- The manual indexed (hand crank) head operates at ratio 40:1; i.e. 1 spindle revolution of 9 degrees per 40 crank turns.
- This allows your operator to accurately position the workpiece to any angle with an indexing plate.
- It is suitable for indirect as well as differential indexing.
- Complete with Gear Head.

Item Code No.	Size
ABM-VC-11340	4-1/2"
ABM-VC-11341	5-1/2"
ABM-VC-11342	6-1/2"
ABM-VC-11343	7-1/2"

Indexing Milling Fixture (Horizontal & Vertical)

- Entire range of horizontal, vertical indexed milling operations can be done with our range of products Job Clamping is fast, indexing is quick thereby increasing production efficiency.
- Indexing Fixture models covers the advantage of conventional Dividing Head and Rotary Table put together.
- Movable Parts are hardened & Ground for long life Indexing accuracy is precise and products can be used on surface grinding also.
- Combination of ball bearings and taper roller bearings on jig bored holes for accurate & easy rotation.
- Tail Stock with lead screw movement is provided for center support of long shaft l jobs.
- Tail Stock Center is sliding in hardened and accurately ground bushes.
- In most models, 24 indexing positions are provided.
- There is also a graduated collar with 1 Degree least count which facilitates odd degree indexing also.
- With all these additional advantages, fixtures are priced much lower than conventional dividing head or rotary table.

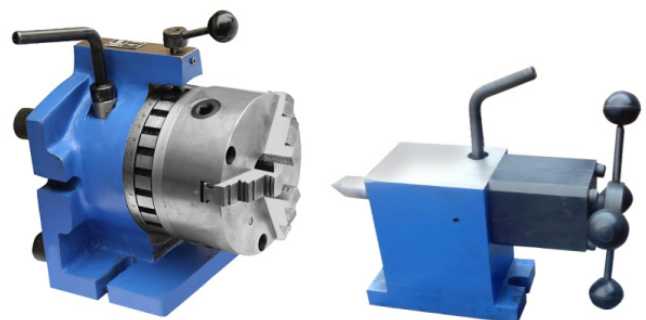

Item Code No.	ABM-VC-11350	ABM-VC-11351	ABM-VC-11352	ABM-VC-11353	ABM-VC-11354
Length - mm	200	200	200	225	225
Width - mm	110	110	110	140	140
Height - mm	185	185	185	240	240
Standard Indexing Positions	24	24	24	24	24
Approx Weight Kg.	24	25	30	45	50
Center Height	85	85	85	120	140
Chuck Details	80 mm 3 Jaw Chuck	100 mm 3 Jaw Chuck	125 mm 3 Jaw Chuck	160 mm 3 Jaw Chuck	200 mm 3 Jaw Chuck
Indexing Accuracy	0.03 15 s	0.03 15 s	0.03 15 s	0.03 15 s	0.03 15 s

Tilting Indexing Device

Item Code No.	ABM-VC-11355	ABM-VC-11356
Size in Inches	4" (100 mm)	8" (200 mm)
Diameter Chuck mm	100	200
Length mm	250	300
Width mm	220	280
Height mm	190	170
Swivel	360 Degree	360 Degree
Tilting	90 Degree	90 Degree
Slots Distance mm	170	275
Weight Approx Kg.	16	62



Modular Machine Vice Cum Slotted Table

- Multi purpose 2 way axis Interchangeable machine modular vice cum slotted table.
- Robust construction manufactured from closed grain high tensile seasoned cast iron.
- Used for milling, shaping, drilling, grinding etc.
- This vice can be replaced by t-slot table provided in the set.
- Tilting movement 0-45°
- Horizontal movement 0-90°
- Fixed rotary base provide with 360° rotation.
- Jaws are hardened and ground.

Contains : Set of 3 pcs.

Vice – 1 Unit

Revolving Base – 1 Unit

Tee Slotted Table – 1 Unit



Item Code No.	Vice Jaw Width		Vice Jaw Opening		Vice Jaw Depth		Table Size	
	Inch	mm	Inch	mm	Inch	mm	Inch	mm
ABM-EPT-11610	2"	50	2"	50	1"	25	5" x 4"x 7/8"	125 x 100 x 22
ABM-EPT-11611	3"	75	3"	75	1-1/4"	32	8" x 6"x 1-1/4"	200 x 150 x 28
ABM-EPT-11612	4"	100	4"	100	1-1/2"	38	10" x 8"x 1-9/16"	250 x 200 x 40

Horizontal & Vertical Two Direction Rapid Indexer

- Useful for 2 Direction Horizontal & Vertical milling and drilling operations.
- 3 Jaw Chuck fitted Head with Big range clamping capacity.
- Dividal number 24-notch (15° each).
- Table scale 1° for angular indexing.
- Horizontal / Vertical & 2 direction.
- Suit for milling & drilling machine.
- It has a 3 Jaw chuck fitted on the head for big range clamping.
- The indexer has a simple rapid operation with Dividal number 24-notch (15° each) and Table scale 1° for angular indexing.

Item Code No.	3 Jaw Chuck	
	Inch	mm
ABM-VC-11560	3-3/16"	80
ABM-VC-11561	4"	100
ABM-VC-11562	5"	125

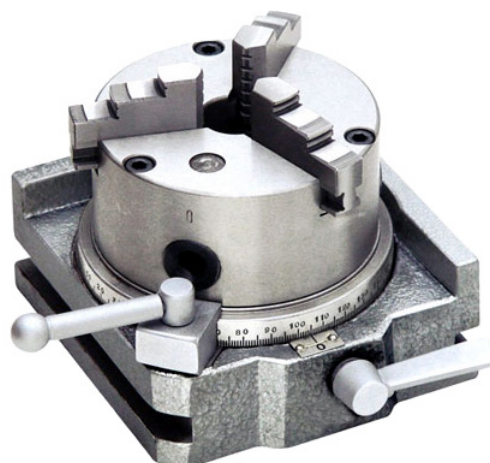

Work Holding Device



Rotary Table

Square Base 2 Slot - 98 mm



Item Code No.

ABM-VC-8800

- This Rotary Table has a Table diameter of 98 mm and fits into the MYFORD vertical slide directly.
- Base dimension of the table is 100 mm x 100mm x 55 mm .
- Table is graduated 0- 360 degrees and works on a ratio of 60: 1, which basically means that 1 handle rotation would turn the table by 6 degrees.

Rotary Table

For Watchmaker's, Jewelry, Milling - 2-3/8"

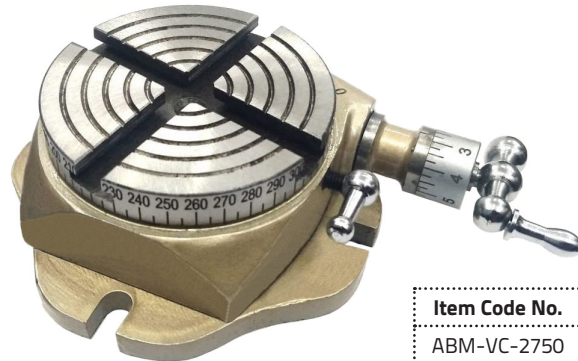

Item Code No.

ABM-VC-2750

- Rotary Tables for Watchmakers, Jewelry, Milling (small 2-3/4")
- 2-3/4" (68 mm) Small Rotary Table
- 4 T Slots
- Table Ratio 1 : 48
- 4 Mounting T Slots between Center for fixing to a table.
- T – Slots are 7 mm deep x 7 mm at thin point x 12 mm at bottom
- Overall Height is 40 mm
- Can be used on the Lathe as well as Milling Machines

Rotary Table

Horizontal & Vertical - 3" / 75 mm



- Available Rotary Milling Table Plain and Horizontal & Vertical System.
- Available with and without indexing Device.
- Dual position tables used for indexing, circular cutting, angle setting, boring and spot facing operations
- Horizontal and Vertical Rotary Table comes with 360 degree graduations.
- Features dual positive action locks with extra deep coolant channel.
- Table clamping surface are precision ground and cylindrical center bore concentric.
- Table Surface id accurately Ground and base of the body to ensure smooth Rotation.

Item Code No.	Type	Table Dia.	Overall Height	T Slot Width	Gear Ratio
ABM-VC-2500	H&V	3" (75 mm)	1-3/4" (45 mm)	13 mm	36 : 1
ABM-VC-2501	Rotary Table + Clamping kit				
ABM-VC-2502	Rotary Table + 3 Jaw 65 mm Self Centering Lathe Chuck + Back Plate				
ABM-VC-2503	Rotary Table + 4 Jaw 70 mm Independen Lathe Chuck + Back Plate				

Rotary Table

Tilting - 3" / 75 mm

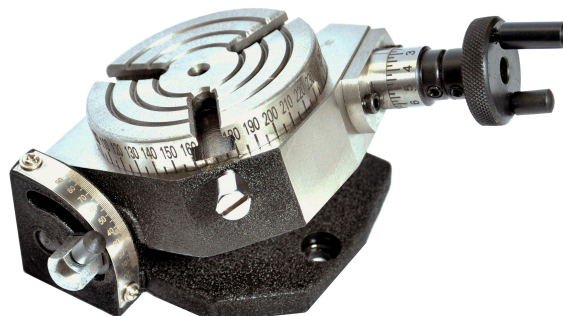

- Available Rotary Milling Table Plain and Horizontal & Vertical System.
- Available with and without indexing Device.
- Dual position tables used for indexing, circular cutting, angle setting, boring and spot facing operations
- Features dual positive action locks with extra deep coolant channel.
- Table clamping surface are precision ground and cylindrical center bore concentric.
- Table Surface id accurately Ground and base of the body to ensure smooth Rotation.
- Table tilts upto 90° and can be used anywhere in between and locked.
- The table is graduated 0-360° in 5° divisions

Item Code No.	Type	Table Dia.	Overall Height	T Slot Width	Gear Ratio
ABM-VC-2520	H&V	3" (75 mm)	1-3/4" (45 mm)	13 mm	36 : 1
ABM-VC-2521	Rotary Table + Clamping kit				
ABM-VC-2522	Rotary Table + 3 Jaw 65 mm Self Centering Lathe Chuck + Back Plate				
ABM-VC-2523	Rotary Table + 4 Jaw 70 mm Independen Lathe Chuck + Back Plate				

Rotary Table

Horizontal & Vertical - 4" / 100 mm

- Available Rotary Milling Table Plain and Horizontal & Vertical System.
- Available with and without indexing Device.
- Dual position tables used for indexing, circular cutting, angle setting, boring and spot facing operations
- Horizontal and Vertical Rotary Table comes with 360 degree graduations.
- Features dual positive action locks with extra deep coolant channel.
- Table clamping surface are precision ground and cylindrical center bore concentric.
- Table Surface id accurately Ground and base of the body to ensure smooth Rotation.

Item Code No.	Type	Table Dia.	Overall Height	T Slot Width	Gear Ratio
ABM-VC-2540	H&V	4" (100 mm)	2-1/4" (57 mm)	13 mm	36 : 1
ABM-VC-2541	Rotary Table + Clamping kit				
ABM-VC-2542	Rotary Table + 3 Jaw 65 mm Self Centering Lathe Chuck + Back Plate				
ABM-VC-2543	Rotary Table + 4 Jaw 70 mm Independen Lathe Chuck + Back Plate				



Rotary Table

Tilting MT2 - 4" / 100 mm



- Can be tilted from 0 to 180 Degree.
- Table clamping surface are precision ground and cylindrical center bore concentric.
- Table Surface id accurately Ground and base of the body to ensure smooth Rotation.
- Engage & Disengage function for manual indexing.
- Center Sleeve is MT2.
- Vertical Center Height is 85 mm.

Item Code No.	Type	Table Dia.	Overall Height	T Slot Width	Gear Ratio
ABM-VC-2580	Tilting	4" (100 mm)	2-1/2" (66 mm)	14 mm	72 : 1
ABM-VC-2581	Rotary Table + Clamping kit				
ABM-VC-2582	Rotary Table + Clamping kit + Tailstock				

Rotary Table

Tilting - 4" / 100 mm

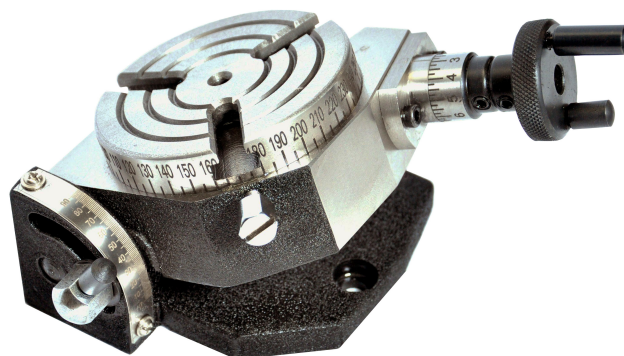

- Available Rotary Milling Table Plain and Horizontal & Vertical System.
- Available with and without indexing Device.
- Dual position tables used for indexing, circular cutting, angle setting, boring and spot facing operations
- Features dual positive action locks with extra deep coolant channel.
- Table clamping surface are precision ground and cylindrical center bore concentric.
- Table Surface id accurately Ground and base of the body to ensure smooth Rotation.
- Hand Wheel can be set to zero
- Hand Wheel graduated in 10 min divisions
- Calibrated in 5 min increment around the rim
- 36 : 1 ratio
- The table is Graduated 0 – 360° in 5 min divisions
- Table tilts upto 90° and can be used anywhere in between and locked.

Item Code No.	Type	Table Dia.	Overall Height	T Slot Width	Gear Ratio
ABM-VC-2560	Tilting	4" (100 mm)	2-5/8" (67 mm)	13 mm	36 : 1
ABM-VC-2561	Rotary Table + Clamping kit				
ABM-VC-2562	Rotary Table + 3 Jaw 65 mm Self Centering Lathe Chuck + Back Plate				
ABM-VC-2563	Rotary Table + 4 Jaw 70 mm Independen Lathe Chuck + Back Plate				

Work Holding Device



Rotary Table

Tilting - 4-3/8" / 110 mm

- Center Bore MT-2
- Gear Ratio 90 : 1
- This Rotary Table is manufactured from Close Grained Graded Cast Iron
- Table Diameter 4-3/8" (110 mm)
- Vertical Center Height 86 mm
- These tables has a totally ground finish which provides high precision and smooth rotation.
- Can be Tilted from 0 to 180 Degree.
- Engage & Disengage function for manual indexing.

Item Code No.	Type	Table Dia.	Overall Height	T Slot Width	Gear Ratio
ABM-VC-2620	Tilting	4-3/8" (110 mm)	5" (126 mm)	17 mm	90 : 1
ABM-VC-2621	Rotary Table + Clamping kit				
ABM-VC-2622	Rotary Table + Dividing Plate Set				
ABM-VC-2623	Rotary Table + Dividing Plate Set + Tailstock				

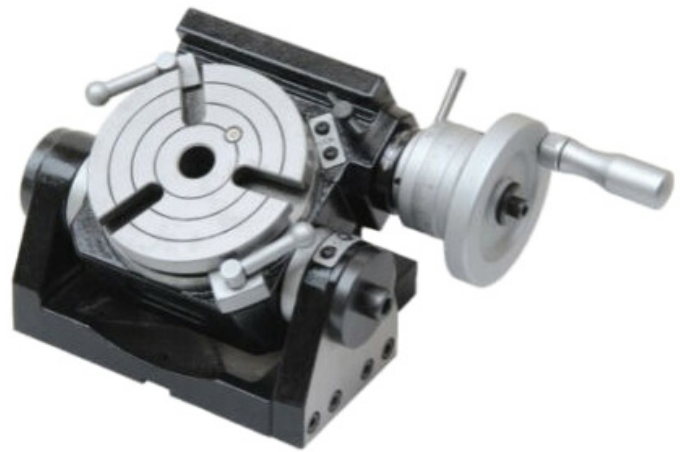

Rotary Table

Horizontal & Vertical - 4-3/8" / 110 mm

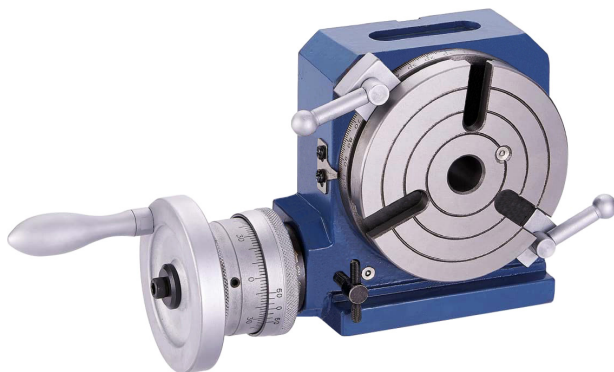

- Center Bore MT-2
- Gear Ratio 90 : 1
- This Rotary Table is manufactured from Close Grained Graded Cast Iron
- Table Diameter 4-3/8" (110 mm)
- Vertical Center Height 86 mm
- Rotary Table Can be used either Horizontally or Vertically.
- These tables has a totally ground finish which provides high precision and smooth rotation.

Item Code No.	Type	Table Dia.	Overall Height	T Slot Width	Gear Ratio
ABM-VC-2590	H & V	4-3/8" (110 mm)	3-1/8" (80 mm)	17 mm	90 : 1
ABM-VC-2591	Rotary Table + Clamping kit				
ABM-VC-2592	Rotary Table + Dividing Plate Set				
ABM-VC-2593	Rotary Table + Dividing Plate Set + Tailstock				

Rotary Table

Horizontal & Vertical - 5" / 125 mm

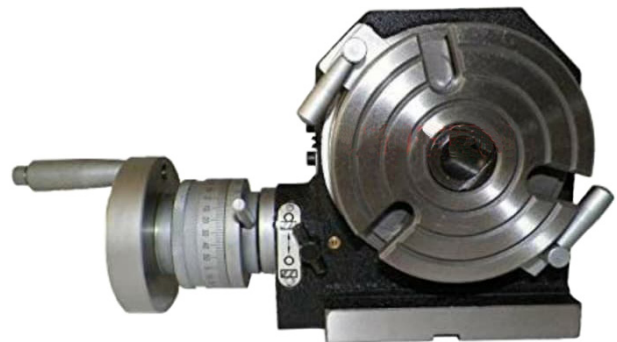

- Table Diameter 5" (125/ 127 mm).
- Overall Height in vertical position 90 mm.
- Worm Gear Ratio 1:72 which means that the 1 handle rotation shall turn the table by 5°.
- T Slot width (Top of the table): 12 mm.
- Table Graduated 360°, Vernier Scale is calibrated to 10 seconds.
- Center Bore of the Table 2 MT.
- Can be clamped in Horizontal as well as vertical.

Item Code No.	Type	Table Dia.	T Slot Width	Gear Ratio
ABM-VC-2640	H & V	5" (125 mm)	12 mm	72 : 1
ABM-VC-2641	Rotary Table + Clamping kit			
ABM-VC-2642	Rotary Table + 3 Jaw 65 mm Self Centering Lathe Chuck + Back Plate			
ABM-VC-2643	Rotary Table + 4 Jaw 70 mm Independent Lathe Chuck + Back Plate			

Work Holding Device



Rotary Table

Tilting - 6" / 150 mm

- Available Rotary Milling Table Plain and Horizontal & Vertical System.
- Available with and without indexing Device.
- Dual position tables used for indexing, circular cutting, angle setting, boring and spot facing operations
- Features dual positive action locks with extra deep coolant channel.
- Table clamping surface are precision ground and cylindrical center bore concentric.
- Table Surface id accurately Ground and base of the body to ensure smooth Rotation
- Gear Ratio 90 : 15 & Center Sleeve MT 2
- Can be Tilted from 0 to 180 Degree. Engage & Disengage function for manual indexing.

Item Code No.	Type	Table Dia.	Overall Height	Vertical Center Height	T Slot Width
ABM-VC-2690	Tilting	6" (150 mm)	5" (125 mm)	97 mm	16 mm
ABM-VC-2691	Rotary Table + Clamping kit				
ABM-VC-2692	Rotary Table + Dividing Plate Set				
ABM-VC-2693	Rotary Table + Dividing Plate Set + Tailstock				

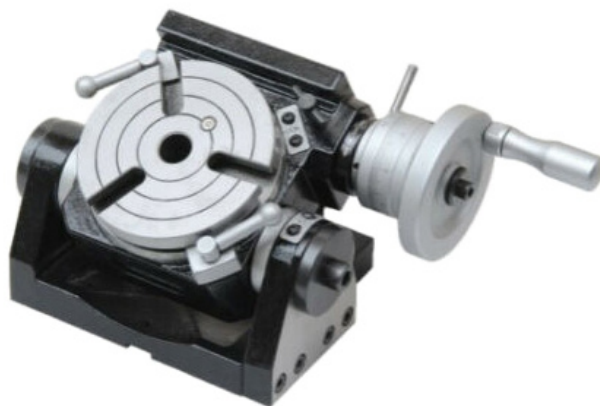

Rotary Table

Horizontal & Vertical - 6" / 150 mm

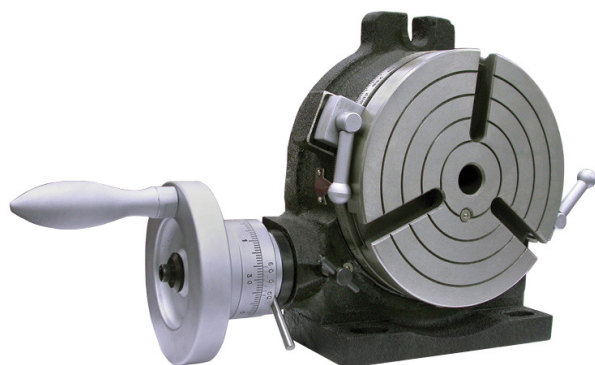

- Available Rotary Milling Table Plain and Horizontal & Vertical System.
- Available with and without indexing Device.
- Dual position tables used for indexing, circular cutting, angle setting, boring and spot facing operations
- Horizontal and Vertical Rotary Table comes with 360 degree graduations.
- Features dual positive action locks with extra deep coolant channel.
- Table clamping surface are precision ground and cylindrical center bore concentric.
- Table Surface id accurately Ground and base of the body to ensure smooth Rotation
- Gear Ratio 90 : 15
- Center Sleeve MT 2

Item Code No. 3 Slots	Item Code No. 4 Slots	Type	Table Dia.	Overall Height	Vertical Center Height	T Slot Width
ABM-VC-2660	ABM-VC-2664	Tilting	6" (150 mm)	5" (125 mm)	97 mm	16 mm
ABM-VC-2661	ABM-VC-2665	Rotary Table + Clamping kit				
ABM-VC-2662	ABM-VC-2666	Rotary Table + Dividing Plate Set				
ABM-VC-2663	ABM-VC-2667	Rotary Table + Dividing Plate Set + Tailstock				

Rotary Table

Horizontal & Vertical - 8" / 200 mm

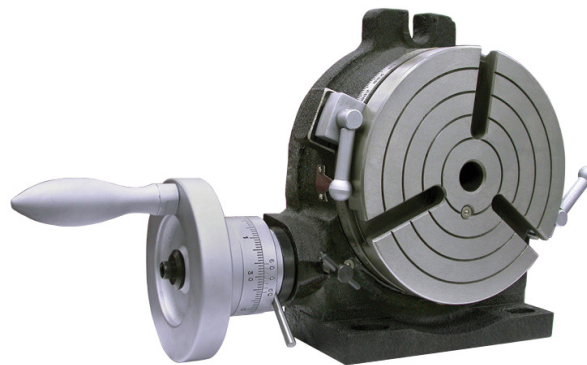

- Available Rotary Milling Table Plain and Horizontal & Vertical System.
- Available with and without indexing Device.
- Dual position tables used for indexing, circular cutting, angle setting, boring and spot facing operations
- Horizontal and Vertical Rotary Table comes with 360 degree graduations.
- Features dual positive action locks with extra deep coolant channel.
- Table clamping surface are precision ground and cylindrical center bore concentric.
- Table Surface id accurately Ground and base of the body to ensure smooth Rotation
- Gear Ratio 90 : 1
- Center Sleeve MT 3

Item Code No. 3 Slots	Item Code No. 4 Slots	Type	Table Dia.	Overall Height	Vertical Center Height	T Slot Width
ABM-VC-2670	ABM-VC-2674	Tilting	6" (150 mm)	5" (125 mm)	97 mm	16 mm
ABM-VC-2671	ABM-VC-2675	Rotary Table + Clamping kit				
ABM-VC-2672	ABM-VC-2676	Rotary Table + Dividing Plate Set				
ABM-VC-2673	ABM-VC-2677	Rotary Table + Dividing Plate Set + Tailstock				

Work Holding Device

Work Holding Device

Work Holding Device

Work Holding Device

Rotary Milling Table

(Rotary Milling Table Horizontal & Vertical System) (With Indexing Device) 3" to 24"

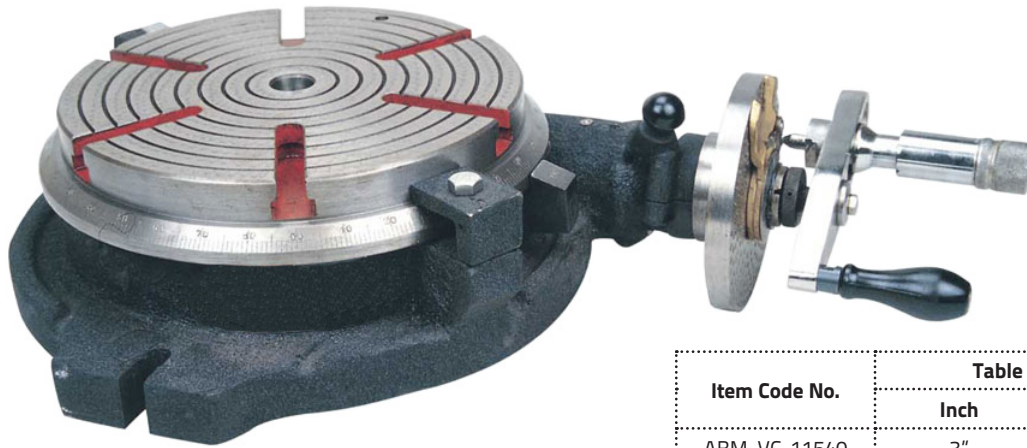

- Available Rotary Milling Table Plain and Horizontal & Vertical System.
- Available with and without indexing Device.
- Dual position tables used for indexing, circular cutting, angle setting, boring and spot facing operations
- Horizontal and Vertical Rotary Table comes with 360 degree graduations.
- Features dual positive action locks with extra deep coolant channel.
- Table clamping surface are precision ground and cylindrical centre bore concentric.
- Table Surface id accurately Ground and base of the body to ensure smooth Rotation. Gear Ratio 90 : 15

Item Code No.	Table Size	
	Inch	mm
ABM-VC-11540	3"	75
ABM-VC-11541	4"	100
ABM-VC-11542	6"	150
ABM-VC-11543	8"	200
ABM-VC-11544	10"	250
ABM-VC-11545	12"	300
ABM-VC-11546	15"	375
ABM-VC-11547	18"	450
ABM-VC-11548	20"	500
ABM-VC-11549	24"	600

Rotary Table

Set For Watchmaker's, Jewellery, Milling - 2-3/4" / 68 mm

SET CONTAINS :

1. Rotary Tables 2-3/4" (68 mm) (Item Code No ABM-VC-2750) – 1 No.
2. Tail Stock – 1 No.
3. Precision Lathe Chuck – 1 No.

Mounts smoothly over the backplate (provided)
3 Jaw Self Centering or 4 Jaw Independent Chuck

Item Code No.	Description
ABM-VC-2860	With 3 Jaw Self Centering Chuck
ABM-VC-2861	With 4 Jaw Independent Chuck



Rotary Table 3" Tilting Set 3" / 75 mm

SET CONTAINS :

1. Rotary Tables 3" (75 mm) (Item Code No ABM-VC-2520) – 1 No.
Worm Gear has 36:1 ratio
The hand wheel is in 10 min divisions and can be set at 0
The table is calibrated in 5° increments around the rim.
2. Back Plate – 1 No.
3. Chuck – 1 No.
3 Jaw Self Centering 65 mm or 4 Jaw Independent 70mm
4. T Nuts – 3 Nos.

Item Code No.	Description
ABM-VC-2790	With 3 Jaw Self Centering Chuck 65 mm
ABM-VC-2791	With 4 Jaw Independent Chuck 70 mm



Rotary Table 3" Set 3" / 75 mm with 3 or 4 Jaws Chuck

SET CONTAINS :

1. Rotary Tables 3" (75 mm) (Item Code No ABM-VC-2500) – 1 No.
Table height 45 mm (1-3/4")
Table height with Chuck 95 mm , Worm Gear has 36:1 ratio
The hand wheel is in 10 min divisions and can be set at 0
The table is calibrated in 5° increments around the rim.
2. Precision Lathe Chuck – 1 No.
Mounts smoothly over the backplate (provided)
3 Jaw Self Centering 65 mm or 4 Jaw Independent 70mm
3. Clamping Kit (M6) – 1 Set.
2 x Slotted Clamps (40 mm x 20 mm)
2 x 6 mm Studs 50 mm long with nuts
2 x Step Clamps 25 x 15 mm
4. Back Plate – 1 No.

Item Code No.	Description
ABM-VC-2780	With 3 Jaw Self Centering Chuck 65 mm
ABM-VC-2781	With 4 Jaw Independent Chuck 70 mm



Rotary Table 4" Set 4" / 100mm - With Tailstock, Clamping Kit & Chuck

SET CONTAINS :

1. Rotary Tables 4" (100 mm) (Item Code No ABM-VC-2540) – 1 No.
Chuck Diameter 4" (100 mm). Can be used both Horizontally & Vertically.
Vertical Center Height 2-1/16" (Approx. 51 mm)
Hand Wheel can be set to zero, Hand Wheel graduated in 10 min divisions
Calibrated in 5 min increment around the rim, 36 : 1 ratio
2. Back Plate – 1 No.
3. Chuck – 1 No.
3 Jaw Self Centering 65 mm or 4 Jaw Independent 70mm
4. Clamping Kit – M6 – 1 Set
2 x Slotted Clamps (40 mm x 20 mm)
2 x 6 mm Studs 50 mm long with nuts
2 x Step Clamps 25 x 15 mm
Suitable Set of T Nuts, Studs and Clamps
5. Tailstock – 1 No.
This adjustable Tail Stock is suitable for all the 4" (100 mm) Rotary Tables
Fully adjustable from 2-1/4" – 3-1/2"

Item Code No.	Description
ABM-VC-2820	With 3 Jaw Self Centering Chuck 65 mm
ABM-VC-2821	With 4 Jaw Independent Chuck 70 mm

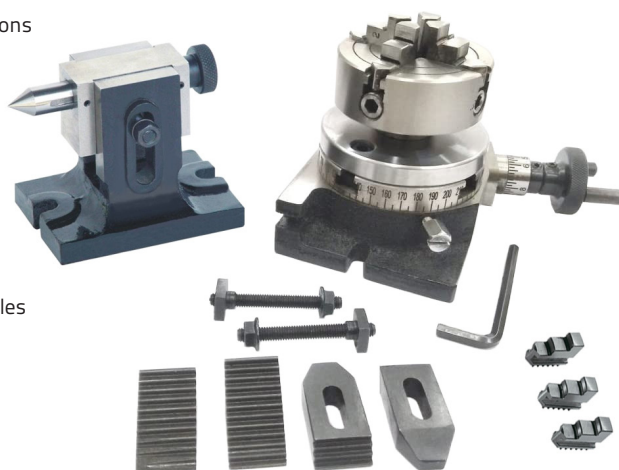

Rotary Table 4" Tilting Set 4" / 100 mm

SET CONTAINS :

1. Rotary Tables 4" (100 mm) (Item Code No ABM-VC-2560) – 1 No.
Worm Gear has 36:1 ratio
The hand wheel is in 10 min divisions and can be set at 0
The table is calibrated in 5° increments around the rim.
2. Back Plate – 1 No.
3. Chuck – 1 No.
3 Jaw Self Centering 65 mm or 4 Jaw Independent 70mm
4. T Nuts – 3 Nos.

Item Code No.	Description
ABM-VC-2810	With 3 Jaw Self Centering Chuck 65 mm
ABM-VC-2811	With 4 Jaw Independent Chuck 70 mm



Rotary Table 4" Set 4" / 100 mm with 3 or 4 Jaws Chuck

SET CONTAINS :

1. Rotary Tables 4" (100 mm) (Item Code No ABM-VC-2540) – 1 No.
Worm Gear has 36:1 ratio
The hand wheel is in 10 min divisions and can be set at 0
The table is calibrated in 5° increments around the rim.
Can be used both Horizontally & Vertically.
2. Precision Lathe Chuck – 1 No.
Mounts smoothly over the backplate (provided)
3 Jaw Self Centering 65 mm or 4 Jaw Independent 70mm
3. Clamping Kit (M6) – 1 Set.
2 x Slotted Clamps (40 mm x 20 mm)
2 x 6 mm Studs 50 mm long with nuts
2 x Step Clamps 25 x 15 mm
Suitable Set of T Nuts, Studs and Clamps
4. Back Plate – 1 No.

Item Code No.	Description
ABM-VC-2800	With 3 Jaw Self Centering Chuck 65 mm
ABM-VC-2801	With 4 Jaw Independent Chuck 70 mm



Rotary Table 5" Set

SET CONTAINS :

1. Rotary Tables 5" (125 mm) (Item Code No ABM-VC-2640) – 1 No.
Table Diameter 5" (127 mm)
Overall Height in vertical position 90 mm
Worm Gear Ratio 1:72 which means that the 1 handle rotation shall turn the table by 5 degrees
T Slot width (Top of the table) : 12 mm
Table Graduated 360 degree, Vernier Scale is calibrated to 10 seconds.
Center Bore of the Table 2 MT
Can be clamped in Horizontal as well as vertical.
2. Set consists of 3 Div Plates & Clamping Kit
3. Tail Stock – 1 No.
Center Height form 80mm to 110mm
4. Clamping Kit – 1 No.
This set include 4 x T Nuts with match 3 Studs and Nuts
2 x 2" Stepped Clamps
2- 1-3/4" Slotted Step Clamps

Item Code No.
ABM-VC-2855



Rotary Table Set

HV4

SET CONTAINS :

1. Rotary Tables 4-3/8" (110 mm) (Item Code No ABM-VC-2590) – 1 No.
Table Diameter 4-3/8" (110 mm)
Rotary Table Can be used either Horizontally or Vertically.
Table has a height of 3" (75 mm). Center Bore MT-2. Gear Ratio 90 : 1
This Rotary Table has three 6 mm T- Slots
These tables has a totally ground finish which provides high precision and smooth rotation.
2. Clamping Kit – M6 – 1 Set
This set comprises 4 x T Nuts with matching 3" Studs and Nuts
2 x 2" Stepped Clamps & 2 x 1-3/4" Slotted Step Clamps
3. Tailstock – 1 No.
Center Height form 80 to 110mm & Base Size 130 x 95 mm
A substantially made Tailstock with center height adjustable over the range 80 to 110 mm.
The base size is 130 x 95 mm and there are 15 mm wide slots at the two ends for securing it to the machine table.
4. Dividing Plate Set – 1 Set.
This excellent dividing attachment can easily be fitted to the HV4 Rotary Table.
A Plate 15, 16, 17, 18, 19, 20
B Plate 21, 23, 27, 29, 31, 33
C Plate 37, 39, 41, 43, 47, 49
Also included are all necessary screw, washers and handle etc.
5. Chuck – 1 No.
3 Jaw Self Centering 65 mm or 4 Jaw Independent 70mm



Item Code No.
ABM-VC-2830

Rotary Table Set

HV4 (4-3/8" / 110 mm)

SET CONTAINS :

1. Rotary Tables 4-3/8" (110 mm) (Item Code No ABM-VC-2590) – 1 No.
Table Diameter 4-3/8" (110 mm)
Rotary Table Can be used either Horizontally or Vertically.
Table has a height of 3" (75 mm)
Center Bore MT-2. Gear Ratio 90 : 1
This Rotary Table has three 6 mm T- Slots
These tables has a totally ground finish which provides high precision and smooth rotation.
2. Clamping Kit – M6 – 1 Set
This set comprises 4 x T Nuts with matching 3" Studs and Nuts
2 x 2" Stepped Clamps
2 x 1-3/4" Slotted Step Clamps
3. Tailstock – 1 No.
This adjustable Tail Stock is suitable for all the 4" (100 mm) Rotary Tables Fully adjustable from 2-1/4" – 3-1/2"
4. Dividing Plate Set – 1 Set.
This excellent dividing attachment can easily be fitted to the HV6 Rotary Table.
A Plate 15, 16, 17, 18, 19, 20
B Plate 21, 23, 27, 29, 31, 33
C Plate 37, 39, 41, 43, 47, 49
Also included are all necessary screw, washers and handle etc.



Item Code No.
ABM-VC-2831

Rotary Table Set

HV6 With Chuck

SET CONTAINS :

1. Rotary Tables 6" (150 mm) (Item Code No ABM-VC-2670) – 1 No.
Manufactured from High Grade Seasoned Casting and Powder Coated wrinkled finish for smooth looks
Table Diameter 6" (150 mm)
Overall Height 3-1/4" (80 mm)
Center Height in vertical position 105 mm
Center Bore MT-2
Gear Ratio 90 : 1
T Slot 16mm
Horizontal Height approx. 80 mm from Base to Top surface of Chuck
Chrome Dials Graduated 360 degree around its circumference.
Also available in HV8 : 200 mm
2. Backplate – 1 No.
3. Chuck – 1 No.
Self Centering 3 Jaw Chuck 100 mm or 4 Jaw Independent 100mm Chuck



Item Code No.

ABM-VC-2850

Rotary Table Set

HV6 - Rotary Table, Tailstock & Indexing Plates Set

SET CONTAINS :

1. Rotary Tables 6" (150 mm) (Item Code No ABM-VC-2670) – 1 No.
Manufactured from High Grade Seasoned Casting and Powder Coated wrinkled finish for smooth looks
Table Diameter 6" (150 mm)
Overall Height 3-1/4" (80 mm)
Center Height in vertical position 105 mm
Center Bore MT-2
Gear Ratio 90 : 1
T Slot 16mm
Horizontal Height approx. 80 mm from Base to Top surface of Chuck
Chrome Dials Graduated 360 degree around its circumference.
Also available in HV8 : 200 mm
2. Tailstock – 1 No.
Center Height form 80 to 110mm
Base Size 130 x 95 mm
A substantially made Tailstock with center height adjustable over the range 80 to 110 mm.
The base size is 130 x 95 mm and there are 15 mm wide slots at the two ends for securing it to the machine table.
3. Dividing Plate Set – 1 Set.
This excellent dividing attachment can easily be fitted to the HV6 Rotary Table.
A Plate: 15, 16, 17, 18, 19, 20
B Plate: 21, 23, 27, 29, 31, 33
C Plate: 37, 39, 41, 43, 47, 49

Comes complete with necessary screw and washers and handles



Item Code No.

ABM-VC-2845

Work Holding Device



Vice

For Rotary Table or Vertical Slide

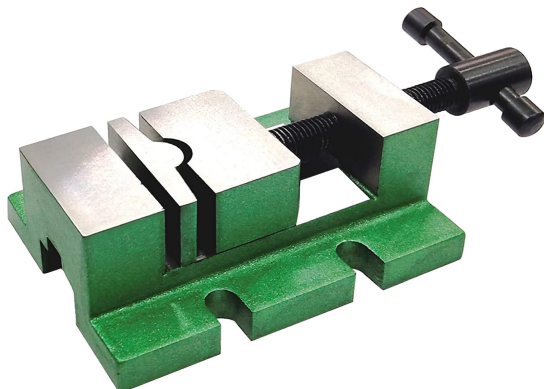

Extra Jaw provided which helps to hold work piece in different angles.
4 Slots provided for mounting on vertical slide both fixed & Swivel.

Item Code No.	Jaw Length	Jaw Depth	Jaw Opening	Overall Length
ABM-VC-2295	45 mm	35 mm	30 mm	135 mm

Mini Vice

For Rotary Table or Vertical Slide

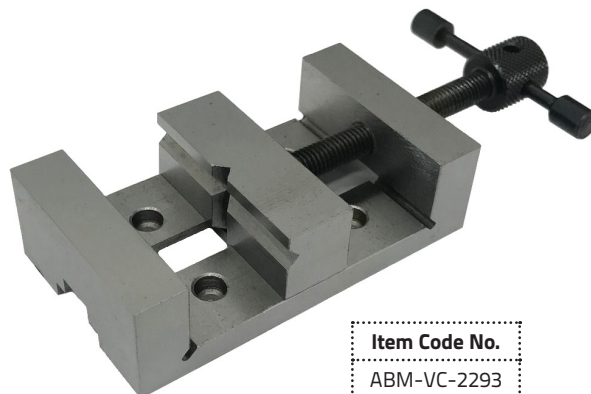

Item Code No.
ABM-VC-2293

4 Holes provided for mounting on Mini Vertical Slide
Jaw Length – 2" / 50 mm
Jaw Opening – 50 mm
Jaw Depth – 18 mm

Small Milling Vice

Myford Lathe

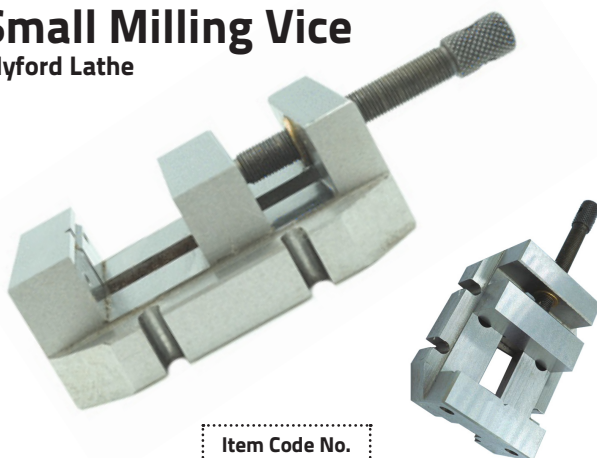

Item Code No.
ABM-VC-2290

Small Milling Vice suitable for Myford Type Milling Slide for Myford Lathes

This new small machine vice is suitable for many small lathes and ideal for anyone with a Myford milling slide etc. The fixed jaw has horizontal and vertical vees for ease of use when holding round material. It can be mounted using either the 2 milled outer slots or the 2 inner drilled holes.

Suitable T nuts included. It can also be used as a standalone vice in either a horizontal or vertical position.

Jaw Width – 60mm
Jaw Opening – 45 mm
Distance between slots – 75mm
Distance Between Holes – 45mm
Overall Height when HZ – 45mm
Overall Height When VT – 110mm (not inc screw)
Footprint when HZ – 110 x 85mm

Round Vice

For Rotary Table or Vertical Slide



Excellent precise compact design.
Supplied with table fixing bolts.
Vice has horizontal and vertical vee in moving jaw.
Made of high grade close grain cast iron.
Designed to fit our 3" (75 mm) & 4" (100 mm) Rotary Tables.
The moving jaw has V-grooves to hold round objects.
Again these vices are drilled in a manner that these can fit to a 3 as well 4 slot table.
The Drills are counter bored to ensure that the fixing screws sets perfectly ensure perfect movement.

Item Code No.	Jaw Length	Jaw Depth	Jaw Opening	Suitable for Rotary Table
ABM-VC-2285	80 mm	20 mm	40 mm	4" / 100 mm
ABM-VC-2286	70 mm	20 mm	28 mm	3" / 75 mm

Work Holding Device



T NUTS

For Rotary Table



T Nuts – For Rotary Tables
Available in various sizes
Economical method of fastening.
Finely Black oxidized.
Resemble T-in Profile.
Provide Better retention.

Item Code No.	Thread	Size
ABM-VC-2275	M 5	12 x 12 mm
ABM-VC-2276	M 6	12 x 12 mm
ABM-VC-2277	M 8	12 x 12 mm
ABM-VC-2278	M 10	19 x 17 mm

Clamping Kits - 24 Pcs.

For Rotary Table



Item Code No.	Thread	Suitable T Slot Size
ABM-VC-2270	M 6	8 mm

Clamping Kits

For Rotary Table



Clamping Kits

For Rotary Table



Clamping Kits suitable for 3" Rotary Tables

Item Code No.	Thread	Suitable for Following Models Rotary Tables	Suitable for Following Models Rotary Tables
ABM-VC-2260	M 5	Suitable for 3" / 75 mm Rotary Tables	Suitable for ABM-VC-2500 ABM-VC-2520 Rotary Tables

Clamping Kits suitable for 4", 5", 6", 8" Rotary Tables
Clamping Kits suitable for HV4, HV5, HV6, HV8 Rotary Tables

Item Code No.	Thread	Suitable for Following Models Rotary Tables	Suitable for Following Models Rotary Tables
ABM-VC-2265	M 6	Suitable for 4" / 100 mm Rotary Tables	Suitable for ABM-VC-2540 ABM-VC-2560 ABM-VC-2580 Rotary Tables
ABM-VC-2266	M 8	Suitable for 4-3/8" / 110 mm 5" / 125 mm 6" / 150 mm Rotary Tables	Suitable for ABM-VC-2590 ABM-VC-2620 ABM-VC-2640 ABM-VC-2660 ABM-VC-2670 ABM-VC-2690 Rotary Tables
ABM-VC-2267	M 10	Suitable for 8" / 200 mm Rotary Tables	Suitable for ABM-VC-2710 ABM-VC-2730 Rotary Tables

Collet Chuck Adapter For Rotary Tables



ER collet chuck for vertical slides boring tables rotary tables MYFORD collet chuck. Collet chuck can be bolted on to apparatus such as rotary tables, vertical slides, boring tables or anything with tee slots.

Item Code No.	Dia.	Collet Type	Suitable for Rotary Table
ABM-VC-2280	80 mm	ER16	3" / 75 mm & 4" / 100 mm
ABM-VC-2281	80 mm	ER25	3" / 75 mm & 4" / 100 mm
ABM-VC-2282	80 mm	R32	3" / 75 mm & 4" / 100 mm

Dividing Plate Sets



Dividing Plates set for HV4 and HV6 Rotary Table
This excellent dividing attachment can easily be fitted to the HV6 Rotary Tables and includes three plates as follows.
Fit to our HV4 and HV6, Tilting Rotary Tables 100 mm
Plate 1 – 15, 16, 17, 18, 19, 20
Plate 2 – 21, 23, 27, 29, 31, 33
Plate 3 – 37, 39, 41, 43, 47, 49
Comes complete with Necessary Screws, Washers & Crank handle.

Item Code No.	Suitable for Following Models Rotary Tables	Suitable for Following Models Rotary Tables
ABM-VC-2250	Suitable for HV4 & HV6 Rotary Tables	Suitable for ABM-VC-2590 ABM-VC-2620 ABM-VC-2660 ABM-VC-2670 ABM-VC-2690 Rotary Tables

Dividing Plate Sets



Dividing Plates set for HV8 Rotary Table
This excellent dividing attachment can easily be fitted to the HV8 Rotary Tables and includes three plates as follows.
Fit to our HV8 Rotary Tables 150 mm / 6"
Plate 1 – 26, 30, 34, 38, 41, 44, 47, 51, 57, 28, 32, 37, 39, 43, 46, 49, 53, 59
Plate 2 – 61, 69, 71, 77, 81, 87, 91, 97, 63, 69, 73, 79, 83, 89, 93, 99
Comes complete with Necessary Screws, Washers & Crank handle.

Item Code No.	Suitable for Following Models Rotary Tables	Suitable for Following Models Rotary Tables
ABM-VC-2255	Suitable for HV8 8" / 200 mm Rotary Tables	Suitable for ABM-VC-2710 ABM-VC-2730 Rotary Tables

Adjustable Tail Stock For Rotary Table 8" / 200 mm

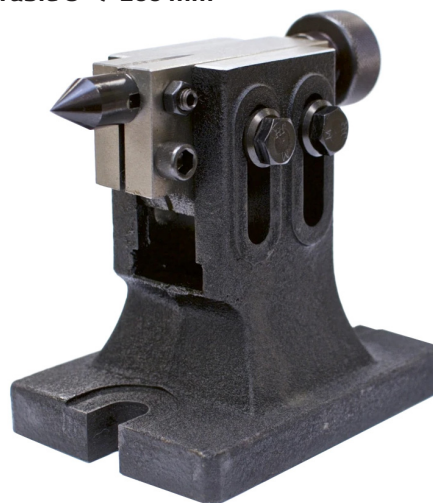

Tailstocks for HV8 Rotary Tables
Very Robust Quality Item in Cast Iron
Quality Tailstock suitable for HV8 Rotary Tables.

Item Code No.	Adjustable Height Min-Max	Suitable for Following Models Rotary Tables	Suitable for Following Models Rotary Tables
ABM-VC-2243	4-3/8 to 6" (110 to 153 mm)	Suitable for 200 mm / 8" Rotary Tables	Suitable for ABM-VC-2710 ABM-VC-2730 Rotary Tables

Work Holding Device



Adjustable Tail Stock Mini Tailstock

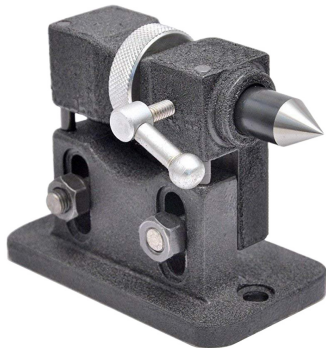

Mini tailstock are relatively inexpensive than any other tailstock. Relatively small & light so they fit into the budgets. Most suitable for small scale units. Manufactured from high quality close grain seasoned casting. Base Dimensions: 50 mm x 120 mm Designed to suit 4" (100 mm) Regular & Tilting Rotary Table. The dead centre is hardened & precision ground.

Item Code No.	Adjustable Height Min-Max	Suitable for Following Models Rotary Tables	Suitable for Following Models Rotary Tables
ABM-VC-2240	3"-4" (75 to 100 mm)	Suitable for 100 mm / 4" Rotary Tables	Suitable for ABM-VC-2540 ABM-VC-2560 ABM-VC-2580 Rotary Tables

Mini Tailstock Tilting

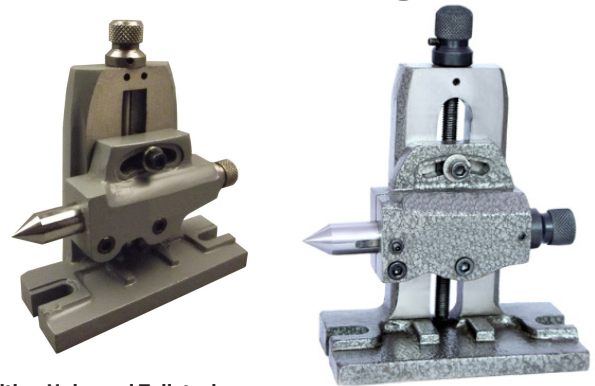

Tilting Universal Tailstock

This high quality universal tailstock with variable centre Height is designed to suit our HV4/ HV5/ HV6 Rotary Tables. The centre height is adjustable by lead screw. Featuring a pivoting centre. The dead centre is induction hardened & precisely ground.

Item Code No.	Adjustable Height Min-Max	Suitable for Following Models Rotary Tables	Suitable for Following Models Rotary Tables
ABM-VC-2235	40 to 95 mm	Suitable for HV4, HV5, HV6 Rotary Tables	Suitable for HV4, HV5, HV6 Rotary Tables
ABM-VC-2236	1-1/2" - 2-1/2" (38 - 63 mm)	Suitable for 75 mm / 3" 100 mm / 4" Rotary Tables	Suitable for ABM-VC-2580 ABM-VC-2500 ABM-VC-2520 ABM-VC-2540 ABM-VC-2560 Rotary Tables

Adjustable Tailstock For Rotary Table HV4, HV5 & HV6



Tailstocks for HV4 & HV6 Rotary Tables Very Robust Quality Item in Cast Iron Quality Tailstock suitable for HV4, HV5 and HV6 Rotary Tables. Base dimension 135mm x 90mm There are 15mm wide slots at the two ends for securing it to the machine table

Item Code No.	Adjustable Height Min-Max	Suitable for Following Models Rotary Tables	Suitable for Following Models Rotary Tables
ABM-VC-2230	3-1/4" - 4-1/4" (78 - 107 mm)	Suitable for 110 mm / 4-3/8" 125 mm / 5" 150 mm / 6" Rotary Tables	Suitable for ABM-VC-2590 ABM-VC-2620 ABM-VC-2660 ABM-VC-2670 ABM-VC-2690 Rotary Tables

Adjustable Tailstock For Rotary Tables

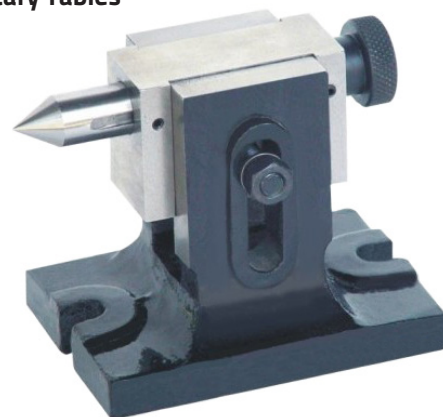

Universal Tail Stocks for 3 inch and 4 inch Rotary Tables This adjustable tail stock is suitable for all the 3" and 4" Rotary Tables

Item Code No.	Adjustable Height Min-Max	Suitable for Following Models Rotary Tables	Suitable for Following Models Rotary Tables
ABM-VC-2225	10-142 mm	Suitable for 75 mm / 3" 100 mm / 4" Rotary Tables	Suitable for ABM-VC-2500 ABM-VC-2520 ABM-VC-2540 ABM-VC-2560 Rotary Tables

Aluminium Back Plates



Back plates with T Nuts

- Excellent quality back plates to mount chucks on the Rotary tables.
- Manufactured from Aluminium.
- Drilled in a manner that they fit both a 3 as well as 4 slot tables.
- In case of MT taper bore Rotary tables, the back plates are provided with an extension to fit to the centre bore so that the centre of the Table and back plate remains absolute co-centric.
- Precision Turned Backplates which allow Chuck to sit Precisely.

Item Code No.	Plate Size	Suitable for Following Models Rotary Tables	Suitable for Following Models Rotary Tables
ABM-VC-2219	4" (100 mm)	Suitable for 100 mm / 4" Rotary Tables	Suitable for ABM-VC-2590 ABM-VC-2620 ABM-VC-2580 Rotary Tables
ABM-VC-2220	6" (150 mm)	Suitable for 150 mm / 6" Rotary Tables	Suitable for ABM-VC-2660 ABM-VC-2670 ABM-VC-2690 Rotary Tables

Back Plates



Back plates with T Nuts

- Excellent quality back plates to mount chucks on the Rotary tables.
- Manufactured from tool Steel & ground finished.
- Drilled in a manner that they fit both a 3 as well as 4 slot tables.
- In case of MT taper bore Rotary tables, the back plates are provided with an extension to fit to the centre bore so that the centre of the Table and back plate remains absolute co-centric.
- Precision Turned Backplates which allow Chuck to sit Precisely.
- Supplied with Suitable T Nuts & Washers.

Item Code No.	Plate Size	Suitable for Following Models Rotary Tables
ABM-VC-2209	2-1/4" (55 mm)	Suitable for 75 mm & 100 mm
ABM-VC-2210	2-1/2" (65 mm)	Suitable for 75 mm & 100 mm
ABM-VC-2211	3-1/4" (80 mm)	Suitable for 100 mm & 125 mm
ABM-VC-2212	4" (100 mm)	Suitable for HV4
ABM-VC-2213	5" (125 mm)	Suitable for HV4 / HV5
ABM-VC-2214	6" (150 mm)	Suitable for HV6

Lathe Chuck Self Centering

3 Jaws Chucks on Backplate for 2-3/4", 3" & 4" Rotary Tables

- This comprises a good quality Slim Body 3 jaw chuck with reversible jaws and adjusting bars mounted on a slotted backplate.
- This will fit any 2-3/4" or 3" or 4" rotary table with 4 slots.
- The chuck mounting is standard Unimat Thread M14 x 1 or M12 x 1
- Overall height from base to top of jaws – 50 mm
- Supplied with suitable T Nuts & Washers.

Item Code No.	Dia. Size	Mounting Thread	Suitable for Following Models Rotary Tables	Suitable for Following Models Rotary Tables
ABM-VC-2870	2" (50 mm)	M12 x 1	Suitable for 2-3/4" / 68 mm 3" / 75 mm 4" / 100 mm Rotary Tables	Suitable for Models ABM-VC-2750 ABM-VC-2500 ABM-VC-2520 ABM-VC-2540 ABM-VC-2560 Rotary Tables
ABM-VC-2871	2-1/2" (65 mm)	M14 x 1	Suitable for 2-3/4" / 68 mm 3" / 75 mm 4" / 100 mm Rotary Tables	Suitable for Models ABM-VC-2750 ABM-VC-2500 ABM-VC-2520 ABM-VC-2540 ABM-VC-2560 Rotary Tables
ABM-VC-2872	2-3/4" (70 mm)	M14 x 1	Suitable for 2-3/4" / 68 mm 3" / 75 mm 4" / 100 mm Rotary Tables	Suitable for Models ABM-VC-2750 ABM-VC-2500 ABM-VC-2520 ABM-VC-2540 ABM-VC-2560 Rotary Tables



Lathe Chuck Independent



4 Jaws Independent Chucks on Backplate for 3" & 4" Rotary Tables

- This comprises a good quality 4 jaw chuck and key mounted on a slotted backplate.
- This will fit any 3 or 4" rotary table with 4 slots.
- The chuck mounting is standard Unimat Thread M14 x 1

Item Code No.	Dia. Size	Suitable for Following Models Rotary Tables	Suitable for Following Models Rotary Tables
ABM-VC-2245	2-3/4" (70 mm)	Suitable for 3" / 75 mm 4" / 100 mm Rotary Tables	Suitable for Models ABM-VC-2500 ABM-VC-2520 ABM-VC-2540 ABM-VC-2560 Rotary Tables

Lathe Chuck - Self Centering

3 Jaws Chucks on Backplate for 4-3/8" & 6" Rotary Tables

- This comprises a good quality Slim Body 3 jaw chuck with reversible jaws and adjusting bars mounted on a slotted backplate.
- This will fit on 4-3/8" & 6" rotary table with 4 slots.
- The chuck mounting is standard Unimat Thread.
- Supplied with suitable T Nuts & Washers.

Item Code No.	Dia. Size	Suitable for Following Models Rotary Tables	Suitable for Following Models Rotary Tables
ABM-VC-2200	3-5/32" (80 mm)	Suitable for 4-3/8" / 110mm Rotary Tables	Suitable for Models ABM-VC-2590 ABM-VC-2620 Rotary Tables
ABM-VC-2201	4" (100 mm)	Suitable for 150 mm / 6" Rotary Tables	Suitable for Models ABM-VC-2660 ABM-VC-2670 ABM-VC-2690 Rotary Tables
ABM-VC-2202	5" (125 mm)	Suitable for 150 mm / 6" Rotary Tables	Suitable for Models ABM-VC-2660 ABM-VC-2670 ABM-VC-2690 Rotary Tables



* Please mention 3 Jaws or 4 Jaws while placing order

Mini Universal Metal Bender

- Designed to forms wire, flat metal and tubing into clamps, handles, brackets, hooks, coils and more
- Makes sharp angle bends up to 5/16" diameter rod and 1 x 1/8" flat metal
- Made of hardened tool steel
- Mounts on a work bench or held in a vise
- Copper tubing bend application is not suitable

Includes:

Circle Pins (3/16, 1/4 and 1/2 in. diameter)
1 of each: Circle die (1 in. Diameter), stop pin, sharp angle die and gauge

Item Code No.	Description
ABM-IMT-8485	Generation 1
ABM-IMT-8486	Generation 2



Mini Rolling and Bending Machine

- Bends Brass Strips, Copper Strips, Wood Strips and other soft metals or materials.
- An easier-to-use tool for making perfect bends in ship model planking.
- Bends up to 2-1/4" (55 mm) wide and 1/8" (3 mm) thick.
- It will also make smooth, no kink curves in plastic and metal strip stock and in 1/16" (1.5mm), 3/32" (2.3mm) and 1/8" (3 mm) tubing and soft wire.
- Simply set the rollers for the desired radius and turn the crank to feed and form the material.
- You can even create perfect radius curves in model railroad rail from N through O scales.
- Precision machined of aluminum with steel gears.
- Rollers are 1/2" (12mm) diameter by 3" (75mm) long.

Item Code No.
ABM-IMT-8480



Mini Bending Brake Aluminium

- Makes Neat Bend 0.5 mm (0.20") half hard brass & 0.8 mm soft Aluminium plate and Similar Sized
 - Mini Sheet metal bender & Press bending brake for brass or other light sheet metals.
 - Makes bends up to 90 degrees by tightening 2 press screws).
 - Can also be used on plastic.
 - Adjustable depth guide permits duplication of bend placement.
 - 3" (75 mm) Wide.
- Copper Strips.

Item Code No.
ABM-IMT-8473



Plate Bench Shear

- Long Level arm/Handle to increase torque force.
- Easy cutting across the entire length.
- Rigid cutter body, directly to a workbench.
- Shear blades are precision hardened steel.
- Designed to cut sheet metal, plate, flat steel, round stock, and rebar.
- Light weight powerful shears for cutting sheets, metal rods & bars.

Item Code No.	Spare Blade Item Code No.	Blade Length	
		Inch	mm
ABM-IMT-8465	ABM-IMT-8475	6"	150
ABM-IMT-8466	ABM-IMT-8476	8"	200
ABM-IMT-8467	ABM-IMT-8477	10"	250
ABM-IMT-8468	ABM-IMT-8478	12"	300

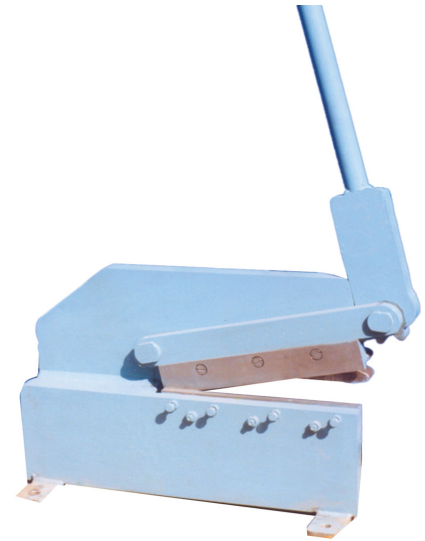
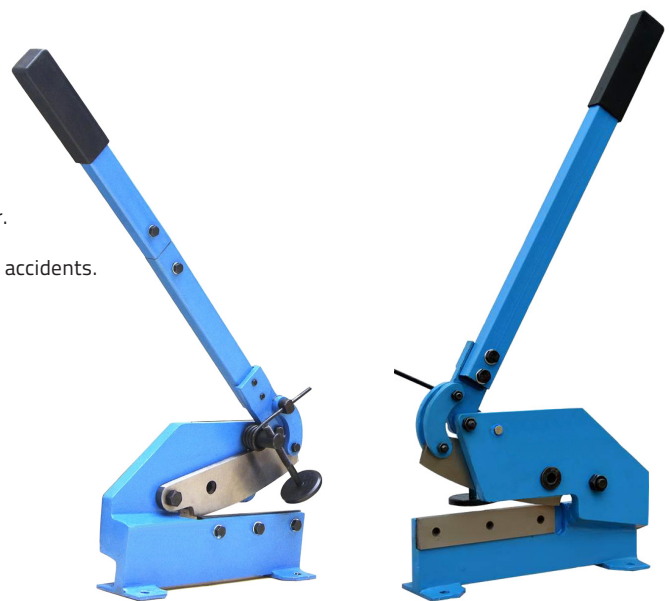

Plate Bench Shear Spring Type

- Level arm with compensating spring.
- Easy cutting across the entire length.
- Rigid cutter body, directly to a workbench.
- An adjustable hold down clamp setting in securing material.
- Shear blades are precision hardened steel.
- Designed to cut sheet metal, plate, flat steel, round stock, and rebar.
- Light weight powerful shears for cutting sheets, metal rods & bars.
- Blade are held in a open position by a strong spring to help prevent accidents.

Item Code No.	Blade Length	
	Inch	mm
ABM-IMT-8455	4"	100
ABM-IMT-8456	5"	125
ABM-IMT-8457	6"	150
ABM-IMT-8458	8"	200
ABM-IMT-8459	10"	250
ABM-IMT-8460	12"	300



Portable Hand Shear

- Mount Portable Hand Shear onto a bench or into a vice, the long handle enables controlled movement of the wheel to cut straight, curved and internal corners.
- Ideal for forming car body parts.
- Cutting Capacity 1/16" / 1.6 mm

Item Code No.
ABM-IMT-8450



Pin Vices & Pin Chuck Set



Hand Vice With Wing Nut



- **ITEM CODE NO ABM-JWT-8000**
- Malleable Iron Jaws have serrations.
- Wing Nut Adjustments.
- Very useful for model makers etc.
- Overall Length 6-1/2", Jaw Opening 5/8".

Hand Drill Pin Vice (Push Drill)



- **ITEM CODE NO ABM-JWT-8001**
- For close dilling of small works.
- At bench provided with one extra chuck.
- It is 180 mm long with 3 times rotation in a stroke.
- Long Body also available with length 7-1/4".

Mini Brass Drill Pin Vice



- **ITEM CODE NO ABM-JWT-8002**
- Ideal for holding small Drills , Pins.
- Capacity 0 to 0.7 mm.
- Brass construction with bright nickel Finish,
- Free Spinning finger grip at chuck.

Master Pin Vice (Hand Drill Pin Vise with Swivel Head)

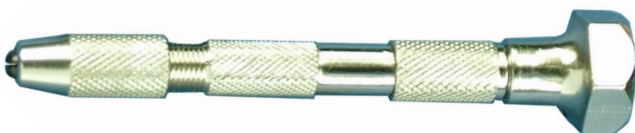

- **ITEM CODE NO ABM-JWT-8003**
- Has 2 double end collets with a capacity 0 to 3.2 mm.
- Screw chuck tightly holds miniature tools and jobs.
- Has swivel Head.
- Bright Nickle plate finish.
- This is a swivel pin vise.
- This can be used as a hand drill with small twist drills or with a screwdriver with small screwdriver blades.
- It is easy to tighten and loosen the end.
- The pin vise holds wire, stock, or tubing for filing.

Double Collet Pin Vice



- **ITEM CODE NO ABM-JWT-8004**
- Ideal tool for holding small jobs.
- Has two collets with knurled body.
- Capacity 0 to .150".
- Overall Length 4".

Square Chuck Pin Vice



- **ITEM CODE NO ABM-JWT-8005**
- Ideal tool for holding small jobs.
- Holding Capacity 0 to .150" (0 to 3.8 mm).
- Overall Length 4".
- Reversible collet with two size capacities at each end.
- Spare Chuck held in end of hollow beass handle.
- Will not roll off bench.

Brass Pin Vice (Mini Pin Vice)



- **ITEM CODE NO ABM-JWT-8006**
- Made of Brass.
- Ideal for holding small Tools, Rods, Wires etc.
- Capacity 0 to .028". Overall Length 4".
- Holds Stud earrings during polishing.
- will Drill holes with drill bits.
- Great for stem and crown replacement.

Double Collet Pin Vice (American Type)



- **ITEM CODE NO ABM-JWT-8007**
- All Brass Body.
- Ideal for holding small jobs.
- Accurate collets.

Triangular Pin Vise



- **ITEM CODE NO. ABM-JWT-8022**
- Ideal for tool to grip small jobs like small taps, files and other similar articles.
- Holding Capacity 3/32" to 7/32"
- Handle made of plastic in triangular shape for easy grip.

Pin Vices & Pin Chuck Set



Small Hand Vice (Hollow Wire Vice)



- **ITEM CODE NO ABM-JWT-8008**
- Small hand vice is very useful for jewelers for holding small wire.
- Wing nut adjustment.
- Knurled Body for easy Grip.

Pin Chuck Set



- **ITEM CODE NO ABM-JWT-8017**
- Designed for holding small drills.
- Three interchangeable collets available.
- Black shiny finish.
- One pin chuck with all three collets : 0 to 1/32", 1/32" to 1/16", 1/16" to 3/32".

Graver Pin Vice



- **ITEM CODE NO ABM-JWT-8009**
- Available with and without Handle.
- Available in Wooden and Plastic handle.

Adapter Pin Chuck Set

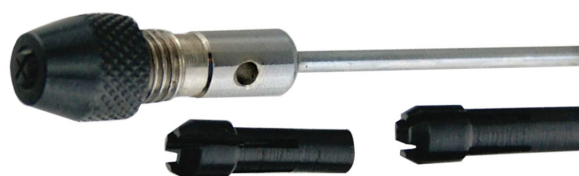

- **ITEM CODE NO ABM-JWT-8018**
- For use with miniature drills. Overall Length 2-5/8".
- Lock this adapter in chuck to convert it for precise drilling.
- Also adapts 3/32" collets on rotary tools and flexible shafts to a more useful 0 to 3/32".
- Comes with two set of jaws (Capacity 0 to 1/16" & 1/16" to 3/32").
- Shank Dia. 3/32", Shank length 1-3/8".

Pin Vice Sliding



- **ITEM CODE NO ABM-JWT-8010**
- Ideal tool to grip small jobs.
- Holding Capacity 0 to 1.3 mm.
- Overall Length 100 mm.
- It has hollow hole slotted through for holding longer wires or objects.

Single Ended Pin Vices



- Ideal vice for holding small tools, wires, taps etc.
- Collets grip firmly when screw chuck is tightened.
- Heavy knurled body. Black shiny finish.
- Available in individual sizes and also in a set of four in attractive pouch.
- Pin Vices are chiefly used for holding small taps, reamers, scribers or wire.
- The handles are tubular which permit holding wires of any length or diameter up to the length of the tool.

Pick Up Tools



- Ideal tool for picking and holding small items.
- Chrome plated knurled body.
- Very handy tool for Machinists, Assemblers, Mechanics and Jewellers.

Item Code No.	Description	Prongs
ABM-JWT-8019	Mini Pick up Tool	Three
ABM-JWT-8020	Standard Pick Up Tool	Three
ABM-JWT-8021	Standard Pick Up Tool	Four
ABM-JWT-8021S	Standard Pick Up Tool	Five

Item Code No.	Capacity
ABM-JWT-8012	0 to 1.0 mm
ABM-JWT-8013	0.8 to 1.5 mm
ABM-JWT-8014	1.3 to 3.1 mm
ABM-JWT-8015	3.0 to 4.8 mm
ABM-JWT-8016	Set of 4 in an attractive Plastic Pouch

Mini Vice Brass Jaws

- **ITEM CODE NO ABM-JWT-8040**
- Small hand vice is very useful for holding small items.

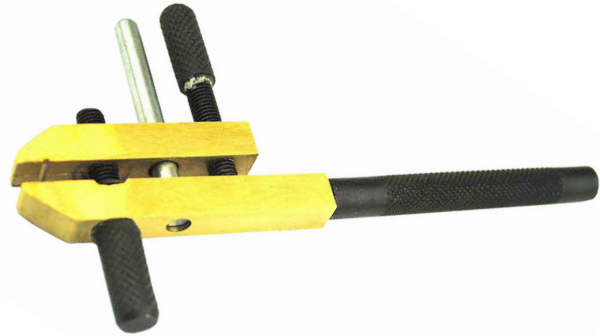

Wooden File Handle with Brass Collet

- **ITEM CODE NO ABM-JWT-8060**
- Excellent quality wooden needle file handle with right size and smooth finish for wonderful feel and grip and very comfortable.
- It is fitted with brass collet chuck to accept all regular needle files.
- Collet Type Needle File Handle With Smooth Wood Handle Hold 14cm & 16 Cm Files.



Pin Tong

- **ITEM CODE NO ABM-JWT-8045**
- This convenient tool is mounted onto a comfortable round handle for easy use. Includes one extra collet.
- Ideal for holding drill bits, reamers, needle files, screws, taps, solder wire, along with other similar applications such as wire wrapping and beading projects.

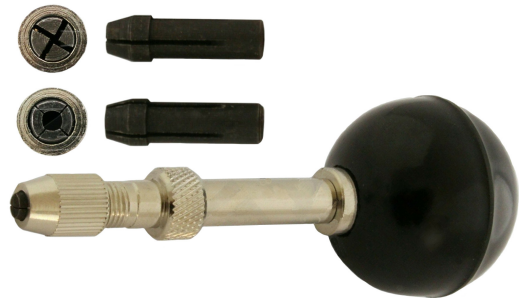

Pin Vice Wooden Handle

- **ITEM CODE NO ABM-JWT-8050**
- This convenient tool is mounted onto a comfortable round handle for easy use. Includes one extra collet.
- Ideal for holding drill bits, reamers, needle files, screws, taps, solder wire, along with other similar applications such as wire wrapping and beading projects.
- With Mushroom style Wooden Handle



Micro Chuck - Micro Pin Chuck

- **ITEM CODE NO ABM-JWT-8055**
- For use with miniature drills.
- Lock this adapter in chuck to convert it for precise drilling.
- The Micro Pin Drill Chuck consists of a micro-chuck that is mounted on a 1/8 or 3/16 shaft
- Used to hold very small (#60-#80) drill bits.
- Grips drills firmly and accurately.



Aluminium Oil Glass Windows



- Made of Aluminium.
- Highly durable and corrosion resistant.
- Available in round and Hexagonal Shape.
- Also available in Brass.

Item Code No.	Size
ABM-LP-11700	1/4" BSP
ABM-LP-11701	3/8" BSP
ABM-LP-11702	1/2" BSP
ABM-LP-11703	3/4" BSP
ABM-LP-11704	1" BSP
ABM-LP-11705	1-1/4" BSP
ABM-LP-11706	1-1/2" BSP
ABM-LP-11707	2" BSP

Oil Windows (Oil Level Indicator)



- This rugged unit is assembled with a clear glass window to show oil level clearly.

Item Code No.	Size
ABM-LP-11708	1"
ABM-LP-11709	1-1/4"
ABM-LP-11710	1-1/2"

Grease Cups (Nut Type)

- Special Grease Cups also available for Sugar Crushers.
- Ball and Spring Type Grease Cups also available on extra cost.

Item Code No.	Size x Thread Specification
ABM-LP-11711	No. 1 x 1/8" BSP
ABM-LP-11712	No. 2 x 1/8" BSP or 1/4" BSP
ABM-LP-11713	No. 3 x 1/8" BSP or 1/4" BSP
ABM-LP-11714	No. 4 x 1/4" BSP
ABM-LP-11715	No. 5 x 1/4" BSP
ABM-LP-11716	No. 6 x 1/4" BSP
ABM-LP-11717	No. 7 x 3/8" BSP
ABM-LP-11718	No. 8 x 3/8" BSP

Grease Nipples



- This is designed to lubricate Agricultural equipment, Earth moving machinery, Motor Vehicle etc..
- Most suitable for attaching to grease nipples.
- Heavy construction steel body. Zinc Finish.
- With or without check valve.
- Thread can be changed according to order.
- Available in Straight, Straight Long, Straight female, 30° Degree, 45° Degree, 65° Degree, 90° Degree, Button Head and Funnel Head.
- Threads available 1/4" x 28, 1/8" NPT, 1/4" NPT, 3/8" NPT, 3/16" Drive, 1/4" Drive, 5/16" Drive, 6 mm, 8 mm, 10 mm.

Item Code No.
ABM-LP-11730

Grease Cups (Moto Type)



Item Code No.	Size x Thread Spec.
ABM-LP-11741	No. 1 x 1/8" BSP
ABM-LP-11742	No. 2 x 1/4" BSP
ABM-LP-11743	No. 3 x 1/4" BSP
ABM-LP-11744	No. 4 x 1/4" BSP
ABM-LP-11745	No. 5 x 1/4" BSP
ABM-LP-11746	No. 6 x 1/4" BSP
ABM-LP-11747	No. 7 x 3/8" BSP
ABM-LP-11748	No. 8 x 3/8" BSP



Grease Nipple (Pin Type)



- Fitted with Non Return Valve.
- Suitable for fitting on manual grease guns and machines.

Item Code No.	Thread Specification
ABM-LP-11780	1/8" BSP
ABM-LP-11781	1/4" BSP
ABM-LP-11782	1/8" NPT
ABM-LP-11783	1/4" NPT
ABM-LP-11784	M10 x 1

Oil Hole Cover (Drive Fit)



- Small Oil covers with Spring Lids.
- Size indicates the diameter of drive fit portion.
- 1/4" Oil Hole cover does not contain Strainer.

Item Code No.	Size
ABM-LP-11830	1/4"
ABM-LP-11831	5/16"
ABM-LP-11832	3/8"
ABM-LP-11833	7/16"

Press Button Oiler (Drive Fit)



- Small Spring loaded Press Button Oilers.

Item Code No.	Size
ABM-LP-11790	3/16"
ABM-LP-11791	1/4"
ABM-LP-11792	5/16"
ABM-LP-11793	3/8"

Spring Lid Oil Cups and Elbow Oiler

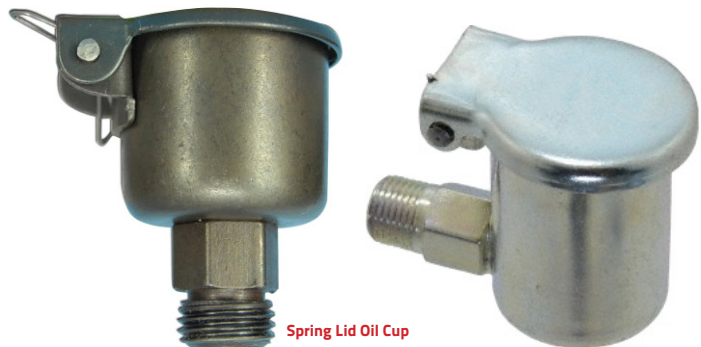

- Also available in NPT Threads.
- While placing order please mention Spring Lid or Spring Lid Elbow Cup.

Item Code No.	Thread	Item Code No.	Thread	Dia
ABM-LP-11840	1/8" BSP	ABM-LP-11860	3/8" BSW	1/2"
ABM-LP-11841	1/8" BSP	ABM-LP-11861	3/8" BSW	5/8"
ABM-LP-11842	1/8" BSP	ABM-LP-11862	3/8" BSW	3/4"
ABM-LP-11843	1/4" BSP	ABM-LP-11863	1/2" BSW	3/4"
ABM-LP-11844	1/8" BSP	ABM-LP-11864	3/8" BSW	7/8"
ABM-LP-11845	1/4" BSP	ABM-LP-11865	1/2" BSW	7/8"
ABM-LP-11846	1/8" BSP	ABM-LP-11866	3/8" BSW	1"
ABM-LP-11847	1/4" BSP	ABM-LP-11867	1/2" BSW	1"
ABM-LP-11848	1/4" BSP	ABM-LP-11868	1/2" BSW	1-1/4"
ABM-LP-11849	1/4" BSP	ABM-LP-11869	1/2" BSW	1-1/2"
ABM-LP-11850	1/4" BSP	ABM-LP-11870	1/2" BSW	2"

Spring Lid Small Oiler

Item Code No.	Thread Specification
ABM-LP-11820	3/16" - 32 TPI
ABM-LP-11821	1/4" - 32 TPI
ABM-LP-11822	3/8" - 24 TPI
ABM-LP-11823	1/8" BSP
ABM-LP-11824	7/16" - 24 TPI
ABM-LP-11825	5/16" - 32 TPI
ABM-LP-11826	1/2" - 24 TPI



Brass Oil Gauge Heavy

- Designed for reliable performance, the oil gauges provided by us are made with qualitative brass
- These oil gauges are corrosion resistant, have long serving life and easy to install.
- Made from Brass

Item Code No.	Size
ABM-LP-11890	1/2" BSP
ABM-LP-11891	1/4" BSP
ABM-LP-11893	1/8" BSP



Brass Oil Gauge Light

- Designed for reliable performance, the oil gauges provided by us are made with qualitative brass.
- These oil gauges are corrosion resistant, have long serving life and easy to install.
- Made from Brass

Item Code No.	Size
ABM-LP-11898	2" - 1/4" BSP
ABM-LP-11899	2" - 3/8" BSP
ABM-LP-11900	2" - 1/2" BSP
ABM-LP-11901	3" - 1/4" BSP
ABM-LP-11902	3" - 3/8" BSP
ABM-LP-11903	3" - 1/2" BSP
ABM-LP-11904	4" - 1/4" BSP
ABM-LP-11905	4" - 3/8" BSP
ABM-LP-11906	4" - 1/2" BSP
ABM-LP-11907	6" - 1/4" BSP
ABM-LP-11908	6" - 3/8" BSP
ABM-LP-11909	6" - 1/2" BSP

Item Code No.	Size
ABM-LP-11910	8" - 1/4" BSP
ABM-LP-11911	8" - 3/8" BSP
ABM-LP-11912	8" - 1/2" BSP
ABM-LP-11913	10" - 1/4" BSP
ABM-LP-11914	10" - 3/8" BSP
ABM-LP-11915	10" - 1/2" BSP
ABM-LP-11916	12" - 1/4" BSP
ABM-LP-11917	12" - 3/8" BSP
ABM-LP-11918	12" - 1/2" BSP



Constant Level Oiler

- A constant-level oiler is used to maintain the fluid level in a piece of equipment that naturally depletes fluid through use, wear, friction, misting or evaporation.

Item Code No.	Size
ABM-LP-11940	70 ml - 1/4"
ABM-LP-11941	120 ml - 1/4"
ABM-LP-11942	70 ml - 3/8"
ABM-LP-11943	120 ml - 3/8"



Drop Sight Feed Oil Lubricator Drip Feed Oiler



- Conventional Gun Metal drop sight feed oiler.
- These oilers have shut off and needle valve oil feed adjustment features.
- A sight glass in shank is provided so that the operator can adjust the feed to proper volume.
- This type of oiler is especially adopted where regulation of the oil feed is required.
- These oilers are recommended where supply of oil under visible control is required.

Item Code No.	Size	Capacity	Thread Specification
ABM-LP-11880	30 mm	20 ml	1/8" or 1/4" B.S.P.
ABM-LP-11881	40 mm	50 ml	1/8" or 1/4" B.S.P.
ABM-LP-11882	52 mm	100 ml	1/4" or 3/8" B.S.P.
ABM-LP-11883	62 mm	170 ml	1/4" or 3/8" B.S.P.
ABM-LP-11884	77 mm	320 ml	3/8" or 1/2" B.S.P.
ABM-LP-11885	88 mm	500 ml	3/8" or 1/2" B.S.P.

Hydraulic Flexible Connectors (Z Type Couplers)

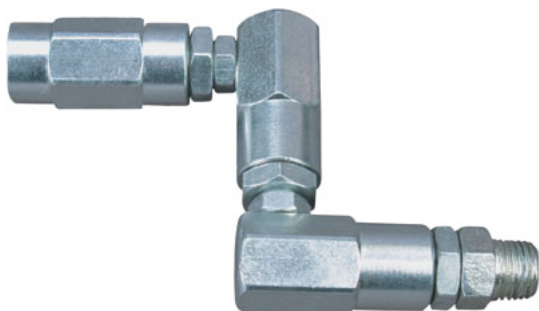

- Special swivel connector for connecting lines at various angles.
- Available with 1/4" x 1/4" BSP and 1/4" x 1/4" NPT Thread.

Item Code No.	Thread Specification
ABM-LP-11920	1/4" x 1/4" B.S.P.
ABM-LP-11921	1/4" x 1/4" N.P.T.

Hydraulic Coupler (Pin Type)



- Hydraulic Coupler Heavy Duty with Locking System.
- Most suitable for attaching to grease nipples.
- Hexagonal nut for easy tightening and removal.
- Quick or positive grip with pin type fitting.
- Working pressure 3000 PSI.
- Chrome or Zinc plated body for hand operated Grease gun.

Item Code No.	Thread Specification
ABM-LP-11930	1/8" BSP
ABM-LP-11931	M10
ABM-LP-11932	1/8" NPT

Hydraulic Couplers



- Standard Hydraulic Coupler available in Light and Heavy Duty with 1/8" BSPT, M10 and 1/8" NPT Threads.

1/8" BSPT Item Code No.	M10 Item Code No.	1/8" NPT Item Code No.	Jaws	Usage
ABM-LP-11950	ABM-LP-11960	ABM-LP-11970	3	Light Duty
ABM-LP-11951	ABM-LP-11961	ABM-LP-11971	4	Light Duty
ABM-LP-11952	ABM-LP-11962	ABM-LP-11972	3	Heavy Duty
ABM-LP-11953	ABM-LP-11963	ABM-LP-11973	4	Heavy Duty

Grease Guns (Lever Type) (Italian Model)

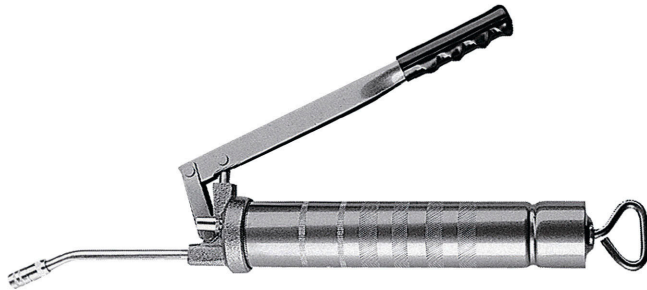

- Italian Model.

Item Code No.	Capacity
ABM-LP-12000	500 Gms.

Grease Guns (Lever Type) (3 Way Loading)



- 3 Way Loading Bulk, Filler Nipple or Cartridge.
- Capacity 20 Oz.

Item Code No.	Capacity
ABM-LP-12008	20 Oz.

Grease Guns (Lever Type) (Cat Filling)



- With Fixed Spout and Coupler.
- Cartridge Filling.

Item Code No.	Capacity
ABM-LP-12003	450 Gms. / 15 Oz.

Grease Guns (Lever Type) (32 Oz)



- With Fixed Spout and Coupler.
- Capacity 32 Oz.

Item Code No.	Capacity
ABM-LP-12010	32 Oz.

Grease Guns (Lever Type) (Cat Filling) (Heavy)



- With Fixed Spout and Coupler.
- Cartridge Filling.
- Heavy Duty.

Item Code No.	Capacity
ABM-LP-12005	450 Gms.

Grease Guns (Lever Type) (10 Oz)



- With Fixed Spout and Coupler.
- Capacity 10 Oz.

Item Code No.	Capacity
ABM-LP-12014	10 Oz.

Grease Guns (Lever Type) (Variable Stroke) (Heavy Duty)



- With Fixed Spout and Coupler.
- Variable Stroke.
- Heavy Duty.

Item Code No.	Capacity
ABM-LP-12018	15 Oz.

Grease Guns (Lever Type - with Cast Head) (15 Oz)



- With Fixed Spout and Coupler.

Item Code No.	Capacity
ABM-LP-12025	15 Oz.

Grease Guns (Lever Type - with Cast Head) (8 Oz)



- With Fixed Spout and Coupler.

Item Code No.	Capacity
ABM-LP-12020	8 Oz.

Grease Guns (Lever Type - with Cast Head) (15 Oz Heavy Duty)



- With Fixed Spout and Coupler.

Item Code No.	Capacity
ABM-LP-12028	15 Oz.

Grease Guns (Lever Type - with Cast Head) (10 Oz)



- With Fixed Spout and Coupler.

Item Code No.	Capacity
ABM-LP-12022	300 Gms / 10 Oz.

Grease Guns (Lever Type - with Steel Head) (15 Oz)



- Available in Wrinkle white.

Item Code No.	Capacity
ABM-LP-12030	15 Oz. / 450 Gms.

Grease Guns (Lever Type - with Steel Head) (500 Gms.)



- With Fixed Spout and Coupler.

Item Code No.	Capacity
ABM-LP-12033	500 Gms.

Grease Guns (All Die Cast Head) (3 Way Loading)



- With Fixed Spout and Coupler.
- 3 Way Loading Bulk, Filler Nipple or Cartridge.

Item Code No.	Capacity
ABM-LP-12036	15 Oz.

Grease Guns (Pistol Type) (Cat Filling) (Heavy) (Aluminium Die Cast Head)



- With Fixed Spout and Coupler.
- Eject in Grease 90 Degree and 180 Degree.

Item Code No.	Capacity
ABM-LP-12040	400 Gms.

Grease Guns (Pistol Type) (Mini)



Item Code No.	Capacity
ABM-LP-12042	3 Oz. / 85 Gms

Grease Guns (Pistol Type) (Professional-Mini)



- With Fixed Spout and Coupler.
- Professional / Deluxe Model.
- Eject in Grease 90 Degree and 180 Degree.

Item Code No.	Capacity
ABM-LP-12045	3 Oz.

Grease Guns (Push Type) (Bed Ford Type)

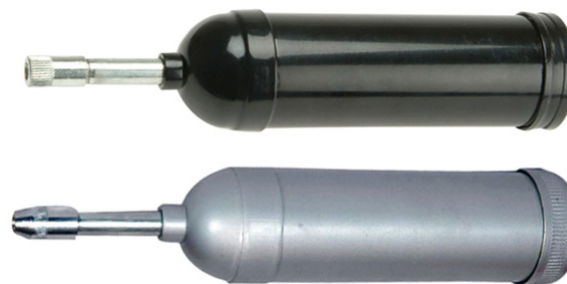

- Color Available Black / Silver).

Item Code No.	Capacity
ABM-LP-12049	4 Oz.
ABM-LP-12050	8 Oz.

Grease Guns (Lever Type) (Mini)



Item Code No.	Capacity
ABM-LP-12055	4 Oz.

Oil Cans (Pint Type) (Pint Type Oiler)



- Metal Body Oil Cans with Pressure pumps.
- Sturdy construction from Heavy gauge tin plates.
- Pumps available in Steel Pumps and Brass pump.
- Separately Rigid, Flexible and Rigid Bend 30 Degree also available.

Rigid Spout Item Code No.	Flexible Spout Item Code No.	Capacity	
		Pint	Mls
ABM-LP-12060	ABM-LP-12066	1/4	125 ml
ABM-LP-12061	ABM-LP-12067	1/2	250 ml
ABM-LP-12062	ABM-LP-12068	3/4	375 ml
ABM-LP-12063	ABM-LP-12069	1	500 ml
ABM-LP-12064	ABM-LP-12070	1-1/2	750 ml
ABM-LP-12065	ABM-LP-12071	2	1000 ml

Oil Cans (Pistol Type)

- Metal Body Oil Cans with Pressure pumps.
- Sturdy construction from Heavy gauge tin plates.
- Pumps available in Steel Pumps and Brass pump.
- Separately Rigid, Flexible and Rigid Bend 30 Degree also
- Available in two Models : General and Heavy Duty.

Rigid Spout Item Code No.	Flexible Spout Item Code No.	Capacity	
		CC	Oz
ABM-LP-12080	ABM-LP-12082	125 cc	4 Oz
ABM-LP-12081	ABM-LP-12083	180 cc	6 Oz

Oil Cans (Perfecto Type) (Perfecto Type Oiler)



- Metal Body Oil Cans with Pressure pumps.
- Sturdy construction from Heavy gauge tin plates.
- Pumps available in Steel Pumps and Brass pump.
- Heavy duty plastic oiler also available.
- Separately Rigid, Flexible and Rigid Bend 30 Degree also available.

Rigid Spout Item Code No.	Flexible Spout Item Code No.	Capacity CC
ABM-LP-12090	ABM-LP-12096	200
ABM-LP-12091	ABM-LP-12097	300
ABM-LP-12092	ABM-LP-12098	400
ABM-LP-12093	ABM-LP-12099	500
ABM-LP-12094	ABM-LP-12100	700
ABM-LP-12095	ABM-LP-12101	1000



Normal

Heavy Duty



Oil Can - Snap Type (Bench Oiler)

- Double-seamed spring steel bottoms plus roll-threaded filler openings for leak-proof body-to-spout connection.



Item Code No.	Capacity
ABM-LP-12110	150 ml
ABM-LP-12111	250 ml

Suction Guns / Suction Pumps Style 1



- Use of any kind corrosive lubricants.

Item Code No.	Capacity
ABM-LP-12115	12 Oz.

Suction Guns / Suction Pumps Style 2



- Use of any kind corrosive lubricants.
- Chrome plated steel based, plastic Cap and Half V pulling Rod.

Item Code No.	Capacity
ABM-LP-12118	12 Oz.

Suction Guns / Suction Pumps Style 3



- Available in all Painted Mat Black Steel body and Chrome plated.
- Front Plane Cap, Back Cap with lock with half V Type Pulling Rod.

Item Code No.
ABM-LP-12120

Suction Guns / Suction Pumps Style 4



- All painted steel barrel with wide knurling for grip.
- Chrome plated steel cap.
- Back Cap with lock with plastic T Type pulling Rod.

Item Code No.
ABM-LP-12122

Suction Guns / Suction Pumps Style 5



- Available in All chrome plated steel body and painted model.
- Chrome plated cap on both side.
- With v type pulling Rod.

Item Code No.
ABM-LP-12125

Transfer Pump (Transfer Gun)



- All painted Steel Body with plastic T Type pulling Rod.
- Recommended for oil based fluid, heating oils, motor oil, low & heavy viscosity oil.
- Avoid to use with water based fluid, antifreeze, solvents & acids.
- Provided with 1 meter vinyl hose for each port.

Item Code No.

ABM-LP-12128

Oil Gun



Item Code No.

ABM-LP-12130

Capacity

8 Oz.

Barrel Pump (Light Duty)



- 1-1/2" Suction pipe ERW quality in 16 SWG.
- Simple Barrel pump with Locking Device.

Item Code No.

ABM-LP-12135

Barrel Pump (Lever Type)



- Use for 50 Liter and 205 Liter Container.
- Deliver 300 ml per Stroke.
- Heavy constructed Steel Lubricated Body

Item Code No.

ABM-LP-12140

Suction Pipe Thread

3/4" -14 TPI

ABM-LP-12141

3/4" -20 TPI

Hand Rotary Pump (Barrel Type)



- Pump and Pipe are Packed Separately in Same Carton Box.

Item Code No.

ABM-LP-12131

Outlet Capacity

Inch

mm

3/4"

19

ABM-LP-12132

1"

25

ABM-LP-12133

1-1/2"

38

Boring Tools (Carbide Tipped)



- Boring tool is used for enlarging the drilling hole.
- Boring bar is used in metalworking and woodworking.
- It is used to achieve greater accuracy of the diameter of a hole, and can be used to cut a tapered hole.
- With carbide tips.
- These tools allow both side and face cutting.
- Featuring ground shanks.
- Extremely hard wearing tools.

C-2 Carbide - Cast Iron Item Code No.	C-6 Carbide - Steel Item Code No.	Shank Dia. A (Inches)	Length B + D (Inches)	Bore Depth D (Inches)	Min Bore C (Inches)
ABM-CT-12200	ABM-CT-12270	3/8"	2"	3/4"	5/16"
ABM-CT-12201	ABM-CT-12271	3/8"	2-3/8"	1-1/8"	5/16"
ABM-CT-12202	ABM-CT-12272	3/8"	2-3/4"	1-1/2"	5/16"
ABM-CT-12203	ABM-CT-12273	3/8"	2-3/16"	15/16"	3/8"
ABM-CT-12204	ABM-CT-12274	3/8"	2-21/32"	1-13/32"	3/8"
ABM-CT-12205	ABM-CT-12275	3/8"	3-1/8"	1-7/8"	3/8"
ABM-CT-12206	ABM-CT-12276	3/8"	2-3/8"	1-1/8"	7/16"
ABM-CT-12207	ABM-CT-12277	3/8"	2-15/16"	1-11/16"	7/16"
ABM-CT-12208	ABM-CT-12278	3/8"	3-1/2"	2-1/4"	7/16"
ABM-CT-12209	ABM-CT-12279	1/2"	2-1/4"	3/4"	5/16"
ABM-CT-12210	ABM-CT-12280	1/2"	2-5/8"	1-1/8"	5/16"
ABM-CT-12211	ABM-CT-12281	1/2"	3"	1-1/2"	5/16"
ABM-CT-12212	ABM-CT-12282	1/2"	2-5/8"	1-1/8"	7/16"
ABM-CT-12213	ABM-CT-12283	1/2"	3-3/16"	1-11/16"	7/16"
ABM-CT-12214	ABM-CT-12284	1/2"	3-3/4"	2-1/4"	7/16"
ABM-CT-12215	ABM-CT-12285	1/2"	3"	1-1/2"	9/16"
ABM-CT-12216	ABM-CT-12286	1/2"	3-3/4"	2-1/4"	9/16"
ABM-CT-12217	ABM-CT-12287	1/2"	4-1/2"	3"	9/16"
ABM-CT-12218	ABM-CT-12288	5/8"	2-1/4"	3/4"	5/16"
ABM-CT-12219	ABM-CT-12289	5/8"	2-5/8"	1-1/8"	5/16"
ABM-CT-12220	ABM-CT-12290	5/8"	3"	1-1/2"	5/16"
ABM-CT-12221	ABM-CT-12291	5/8"	2-5/8"	1-1/8"	7/16"
ABM-CT-12222	ABM-CT-12292	5/8"	3-3/16"	1-11/16"	7/16"
ABM-CT-12223	ABM-CT-12293	5/8"	3-3/4"	2-1/4"	7/16"

C-2 Carbide - Cast Iron Item Code No.	C-6 Carbide - Steel Item Code No.	Shank Dia. A (Inches)	Length B + D (Inches)	Bore Depth D (Inches)	Min Bore C (Inches)
ABM-CT-12224	ABM-CT-12294	5/8"	3"	1-1/2"	9/16"
ABM-CT-12225	ABM-CT-12295	5/8"	2-3/4"	2-1/4"	9/16"
ABM-CT-12226	ABM-CT-12296	5/8"	4-1/2"	3"	9/16"
ABM-CT-12227	ABM-CT-12297	5/8"	3-3/8"	1-7/8"	11/16"
ABM-CT-12228	ABM-CT-12298	5/8"	4-5/16"	2-13/16"	11/16"
ABM-CT-12229	ABM-CT-12299	5/8"	5-1/4"	3-3/4"	11/16"
ABM-CT-12230	ABM-CT-12300	3/4"	3-1/8"	1-1/8"	7/16"
ABM-CT-12231	ABM-CT-12301	3/4"	3-11/16"	1-11/16"	7/16"
ABM-CT-12232	ABM-CT-12302	3/4"	4-1/4"	2-1/4"	7/16"
ABM-CT-12233	ABM-CT-12303	3/4"	3-1/2"	1-1/2"	9/16"
ABM-CT-12234	ABM-CT-12304	3/4"	4-1/4"	2-1/4"	9/16"
ABM-CT-12235	ABM-CT-12305	3/4"	5"	3"	9/16"
ABM-CT-12236	ABM-CT-12306	3/4"	3-11/16"	1-11/16"	11/16"
ABM-CT-12237	ABM-CT-12307	3/4"	4-13/16"	2-13/16"	11/16"
ABM-CT-12238	ABM-CT-12308	3/4"	5-1/4"	3-3/4"	11/16"
ABM-CT-12239	ABM-CT-12309	3/4"	4-1/4"	2-1/4"	13/16"
ABM-CT-12240	ABM-CT-12310	3/4"	5-3/8"	3-3/8"	13/16"
ABM-CT-12241	ABM-CT-12311	3/4"	6-1/2"	4-1/2"	13/16"
ABM-CT-12242	ABM-CT-12312	1"	5"	3"	13/16"
ABM-CT-12243	ABM-CT-12313	1"	5-3/4"	3-3/4"	1-1/16"
ABM-CT-12244	ABM-CT-12314	1"	6-1/2"	4-1/2"	1-7/8"
ABM-CT-12245	ABM-CT-12315	1"	6-1/2"	4-1/2"	1-1/16"
ABM-CT-12246	ABM-CT-12316	1"	7-3/4"	5-3/4"	1-1/2"
ABM-CT-12247	ABM-CT-12317	1"	8-1/4"	6-1/4"	1-1/16"
ABM-CT-12248	ABM-CT-12318	1"	9-1/2"	6-3/4"	1-1/2"
ABM-CT-12249	ABM-CT-12319		Size 5/16" (8 mm) - Set of 9 Pcs.		
ABM-CT-12250	ABM-CT-12320		Size 3/8" (10 mm) - Set of 9 Pcs.		
ABM-CT-12251	ABM-CT-12321		Size 1/2" (12 mm) - Set of 9 Pcs.		
ABM-CT-12252	ABM-CT-12322		Size 3/4" (20 mm) - Set of 12 Pcs.		

Boring Tools (HSS)

- Boring tool is used for enlarging the drilling hole.
- Boring bar is used in metalworking and woodworking.
- It is used to achieve greater accuracy of the diameter of a hole, and can be used to cut a tapered hole.
- Available in HSS M2 quality.
- Also available in HSS M35 (5% Cobalt) Quality.
- Available in individual as well as set of 8 Pcs., 10 Pcs. & 14 Pcs.



Item Code No.	Shank Dia.	Minimum Bore	Bore Depth	Overall Length	Item Code No.	Shank Dia.	Minimum Bore	Bore Depth	Overall Length
ABM-CT-12340	3/8"	3/16"	9/16"	1-13/16"	ABM-CT-12361	5/8"	7/16"	2-3/16"	3-11/16"
ABM-CT-12341	3/8"	3/16"	15/16"	2-3/16"	ABM-CT-12362	5/8"	1/2"	1-1/2"	3"
ABM-CT-12342	3/8"	1/4"	3/4"	2"	ABM-CT-12363	5/8"	1/2"	2-1/2"	4"
ABM-CT-12343	3/8"	1/4"	1-1/4"	2-1/2"	ABM-CT-12364	5/8"	9/16"	1-11/16"	3-3/16"
ABM-CT-12344	3/8"	5/16"	15/16"	2-3/16"	ABM-CT-12365	5/8"	9/16"	2-13/16"	4-5/16"
ABM-CT-12345	3/8"	5/16"	1-9/16"	2-3/16"	ABM-CT-12366	5/8"	5/8"	1-7/8"	3-3/8"
ABM-CT-12346	3/8"	3/8"	1-1/8"	2-3/8"	ABM-CT-12367	5/8"	5/8"	3-1/8"	4-5/8"
ABM-CT-12347	3/8"	3/8"	1-7/8"	3-1/8"	ABM-CT-12368	3/4"	3/8"	1-1/8"	2-7/8"
ABM-CT-12348	1/2"	1/4"	3/4"	2-1/8"	ABM-CT-12369	3/4"	3/8"	1-7/8"	3-5/8"
ABM-CT-12349	1/2"	1/4"	1-1/4"	2-5/8"	ABM-CT-12370	3/4"	7/16"	1-5/16"	3-1/16"
ABM-CT-12350	1/2"	5/16"	15/16"	2-5/16"	ABM-CT-12371	3/4"	7/16"	2-3/16"	3-15/16"
ABM-CT-12351	1/2"	5/16"	1-9/16"	2-15/16"	ABM-CT-12372	3/4"	1/2"	1-1/2"	3-1/4"
ABM-CT-12352	1/2"	3/8"	1-1/8"	2-1/2"	ABM-CT-12373	3/4"	1/2"	2-1/2"	4-1/4"
ABM-CT-12353	1/2"	3/8"	1-7/8"	3-1/4"	ABM-CT-12374	3/4"	9/16"	1-11/16"	3-7/16"
ABM-CT-12354	1/2"	7/16"	1-5/16"	2-11/16"	ABM-CT-12375	3/4"	9/16"	2-13/16"	4-9/16"
ABM-CT-12355	1/2"	7/16"	2-3/16"	3-9/16"	ABM-CT-12376	3/4"	5/8"	1-7/8"	3-5/8"
ABM-CT-12356	1/2"	1/2"	1-1/2"	2-7/8"	ABM-CT-12377	3/4"	5/8"	3-1/8"	4-7/8"
ABM-CT-12357	1/2"	1/2"	2-1/2"	3-7/8"	ABM-CT-12378	3/4"	11/16"	2-1/16"	3-13/16"
ABM-CT-12358	5/8"	3/8"	1-1/8"	2-5/8"	ABM-CT-12379	3/4"	11/16"	3-7/16"	5-3/16"
ABM-CT-12359	5/8"	3/8"	1-7/8"	3-3/8"	ABM-CT-12380	3/4"	3/4"	2-1/4"	4"
ABM-CT-12360	5/8"	7/16"	1-5/16"	2-13/16"	ABM-CT-12381	3/4"	3/4"	3-3/4"	5-1/2"
ABM-CT-12382	8 Pcs Set of Boring Bars Shank Dia. 3/8" in Wooden Block								
ABM-CT-12383	10 Pcs Set of Boring Bars Shank Dia. 1/2" in Wooden Block								
ABM-CT-12384	10 Pcs Set of Boring Bars Shank Dia. 5/8" in Wooden Block								
ABM-CT-12385	14 Pcs Set of Boring Bars Shank Dia. 3/4" in Wooden Block								

Boring & Threading Tools (HSS)

(Boring, Facing Tool and Internal Threading Tool Set - Round Shanks)

- Made of high Speed Steel for Increased production, finer and smoother cuts.
- Holder is provided for holding the tools.
- Set consists of 3 Pcs Boring and Facing Tools, 2 pcs Threading Tools and one Holder.
- Always use good quality of Cutting Tools for best performance of Cutting Tools.

Item Code No.	Shank Size mm	Tool Holder Size mm	Tool Length mm	Min Boring / Threading Dia. Appox. mm
ABM-CT-12400	4	7 x 7	60	7
ABM-CT-12401	6	9 x 9	95	10
ABM-CT-12402	6	9 x 9	130	10
ABM-CT-12403	8	11 x 11	140	14
ABM-CT-12404	10	13 x 13	140	16.5
ABM-CT-12405	12	15 x 15	140	19



Boring Tools (HSS) (Square Shank) (Boring, Facing Tool and Internal Threading Tool Set)

- Made of high Speed Steel for Increased production, finer and smoother cuts.
- Always use good quality of Cutting Tools for best performance of Cutting Tools.

Item Code No.	Size of Shank mm
ABM-CT-12410	6 x 96
ABM-CT-12411	6 x 140
ABM-CT-12412	8 x 140
ABM-CT-12413	10 x 140
ABM-CT-12414	12 x 140



HSS Threading Tool Double Ended 2 Pcs. Set



- Set of 2 Pcs (Double Ended Threading Tool).
- Double Ended 55° & 60°.
- Used for Internal & External Threading.
- Precisely Hardened and Ground.
- Manufactured from HIGH SPEED STEEL (HSS).

Item Code No.	Shank Size Width mm	Shank Size Breadth mm	Shank Size Height mm
ABM-CT-12165	4	4	65
ABM-CT-12166	5	5	65
ABM-CT-12167	6	6	65
ABM-CT-12168	8	8	80
ABM-CT-12169	10	10	100
ABM-CT-12170	12	12	100

HSS Lathe Turning Tools Set of 6 Pcs.

Boring, Facing Tool and Internal Threading Tool Set – Square Shank



- Made of high Speed Steel (HSS M2 Quality) for Increased production, finer and smoother cuts.
- Hardened & Ground (HRC 60 + 2).
- Always use good quality of Cutting Oils for best performance of Cutting Tools.

SET CONSISTS OF (6 Pcs.)

- Boring Tool – 1 Pc
- Internal Threading Tool 55 Degree – 1 Pc
- External 40 Degree Threading Tool – 1 Pc
- Finishing Tool – 1 Pc
- Roughing Turning Tool – 1 Pc
- Parting Tool – 1 Pc

Item Code No.	Size of Shank	Shank Length
ABM-CT-12415	1/4"	3-1/2"
ABM-CT-12416	3/8"	5"
ABM-CT-12417	6 mm	90 mm
ABM-CT-12418	10 mm	125 mm

HSS Lathe Turning Tools

Set of 8 Pcs.

Boring, Facing Tool and Internal Threading Tool Set – Square Shank

- Lathe Turning Tools HSS Quality sets comes in Left Hand (LH) turning tool, Right Hand (RH) turning tools, parting, corner, boring, External and Internal Threading Tools.
- Used for Turning & Facing on Lathe Machines.
- Precisely Hardened and Ground.
- Packed in attractive Wooden Box packing.
- Form Tool Bits are available Sets and Individual.
- COBALT STEEL are suitable for use on tougher materials and all heavy duty applications that require an increased depth of cut. Addition of cobalt gives optimum hardness and toughness thus improving the cutting performance.
- HIGH SPEED STEEL show exceptional results on mild steel, alloy steels and tool steel and are superior finishing tools useful in production processes.
- Also available in odd Lengths and odd sizes.

Available in following Materials

(a) HIGH SPEED STEEL (HSS)
(1) M2 Quality (Single H)

(b) COBALT STEEL
(1) M-35 Quality (5% Cobalt) (Double H)

SET CONSIST OF 8 PCS

Right Hand Turning Tool – 1 Pc

Left Hand Turning Tool – 1 Pc

Straight Cut Threading Tool – Straight Finishing 60° / 55° – 1 Pc

Corner Right Angle Tool – 1 Pc

Boring Tool – 1 Pc

Internal Boring Bar Blind Holes – Internal Threading 60° / 55° – 1 Pc

Parting Tool – 1 Pc

Thread Cutting Tool – Threading 60° / 55° – 1 Pc

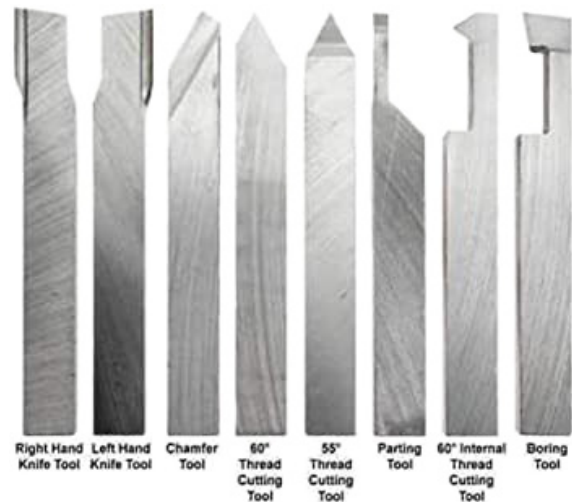

Item Code No. HSS	Item Code No. 5% Cobalt	Size of Shank	Shank Length
ABM-CT-12150	ABM-CT-12156	3.5 mm	63 mm
ABM-CT-12151	ABM-CT-12157	5 mm	63 mm
ABM-CT-12152	ABM-CT-12158	6 mm	63 mm
ABM-CT-12153	ABM-CT-12159	8 mm	80 mm
ABM-CT-12154	ABM-CT-12160	10 mm	80 mm
ABM-CT-12155	ABM-CT-12161	12 mm	100 mm
ABM-CT-14000	ABM-CT-14010	1/8"	2-3/8"
ABM-CT-14001	ABM-CT-14011	1/4"	2-1/2"
ABM-CT-14002	ABM-CT-14012	5/16"	3-1/8"
ABM-CT-14003	ABM-CT-14013	3/8"	4"
ABM-CT-14004	ABM-CT-14014	1/2"	4"

HSS Threading Tool Set of 2 Pcs

- Set of 2 Pcs.
- 55° & 60° External Threading Tool & 55° & 60° Internal Threading Tool
- Used for Internal & External Threading.
- Precisely Hardened and Ground, Manufactured from HIGH SPEED STEEL (HSS).

Item Code No.	Shank Size mm	Shank Size Length mm
ABM-CT-12173	6	63
ABM-CT-12174	8	80
ABM-CT-12175	10	100
ABM-CT-12176	12	100



Indexable Carbide Turning Tool Holder Set of 5 Pcs.

Indexable Carbide Turning Tool Holder (Set of 5 Pcs).

- Versatile of Cutting in any direction.
- Built in Chip Breaker Groove.
- Ready to Use. No Grinding. No Tool Resetting.
- Heat treated and hardened shank
- Economical alternative to Brazed Tool Tip.
- Supplied with and without inserts.

Set Consist of following (5 Pcs Set)

- Style TE: Neutral Threading Tool 60 degree included angle; used for universal threading,
- V-grooving, Chamfering, turning, boring & facing
- Style TBL: Left Hand 15 degree lead angle for rough facing to center or where no shoulder is needed
- Style TAL: Left Hand suitable for facing to a square shoulder
- Style TBR: Right Hand 15 degree lead angle for rough turning where a square shoulder is not needed



Item Code No.	Size of Square Shank	Insert IC	Style	Overall Length
ABM-IMT-6230	3/8"	1/4"	TE-6	2-1/2"
ABM-IMT-6231	3/8"	1/4"	TBL-6	2-1/2"
ABM-IMT-6232	3/8"	1/4"	TAL-6	2-1/2"
ABM-IMT-6233	3/8"	1/4"	TBR-6	2-1/2"
ABM-IMT-6234	3/8"	1/4"	TAR-6	2-1/2"
ABM-IMT-6235	Set of Five Holders with 3/8" shank			
ABM-IMT-6236	1/2"	3/8"	TE-8	3-1/2"
ABM-IMT-6237	1/2"	3/8"	TBL-8	3-1/2"
ABM-IMT-6238	1/2"	3/8"	TAL-8	3-1/2"
ABM-IMT-6239	1/2"	3/8"	TBR-8	3-1/2"
ABM-IMT-6240	1/2"	3/8"	TAR-8	3-1/2"
ABM-IMT-6241	Set of Five Holders with 1/2" shank			
ABM-IMT-6242	5/8"	3/8"	TE-10	4"
ABM-IMT-6243	5/8"	3/8"	TBL-10	4"
ABM-IMT-6244	5/8"	3/8"	TAL-10	4"
ABM-IMT-6245	5/8"	3/8"	TBR-10	4"
ABM-IMT-6246	5/8"	3/8"	TAR-10	4"
ABM-IMT-6247	Set of Five Holders with 5/8" shank			
ABM-IMT-6248	3/4"	3/8"	TE-12	4-1/2"
ABM-IMT-6249	3/4"	3/8"	TBL-12	4-1/2"
ABM-IMT-6250	3/4"	3/8"	TAL-12	4-1/2"
ABM-IMT-6251	3/4"	3/8"	TBR-12	4-1/2"
ABM-IMT-6252	3/4"	3/8"	TAR-12	4-1/2"
ABM-IMT-6253	Set of Five Holders with 3/4" shank			
ABM-IMT-6254	1"	1/2"	TE-16	6"
ABM-IMT-6255	1"	1/2"	TBL-16	6"
ABM-IMT-6256	1"	1/2"	TAL-16	6"
ABM-IMT-6257	1"	1/2"	TBR-16	6"
ABM-IMT-6258	1"	1/2"	TAR-16	6"
ABM-IMT-6259	Set of Five Holders with 1" shank			



Item Code No.	Set of 5 Holders
ABM-CT-6259A	6 mm Shank
ABM-CT-6259B	8 mm Shank
ABM-CT-6259C	10 mm Shank
ABM-CT-6259D	12 mm Shank
ABM-CT-6259E	16 mm Shank
ABM-CT-6259F	20 mm Shank

Indexable Carbide Turning Tool Holder Set of 7 Pcs.



- Versatile of Cutting in any direction.
- Built in Chip Breaker Groove.
- Ready to Use. No Grinding. No Tool Resetting.
- Heat treated and hardened shank
- Economical alternative to Brazed Tool Tip.
- Turning Tool Holder with indexable insert of Carbide Metal quality.
- Have four cutting edges insert shape CCMT.
- Set of 7 Pcs with Key.
- Supplied with and without inserts.

Set Consist of following (7 Pcs Set)

- Left Hand Turning Tool – for Straight turning – 1 Piece
- Right Hand Turning Tool – for Straight turning – 1 Piece
- Right Hand Facing Tool – for Face turning – 1 Piece
- Right Hand Straight Turning Tool – for Straight turning – 1 Piece
- Pointed Turning Tool – for outside thread turning and straight turning – 1 Piece
- Off Pointed Turning Tool – for outside thread turning and straight turning – 1 Piece
- Boring Bar for right hand cutting – for turning out internal bores – 1 Piece

Item Code No.	Shank Size mm	Suitable Carbide Insert
ABM-IMT-6060	6	CCMT 060204
ABM-IMT-6061	8	CCMT 060204
ABM-IMT-6062	10	CCMT 060204
ABM-IMT-6063	12	CCMT 060204
ABM-IMT-6064	16	CCMT 060204
ABM-IMT-6065	20	CCMT 060204

Carbide Brazed Turning Tools Set of 6 Pcs.

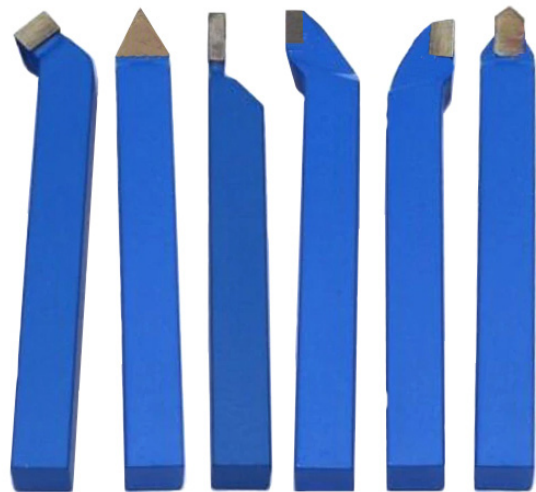

- Set of 6 Pcs.
- Packed in attractive Wooden Box Packing.

SET CONSIST of (6 Pcs) :

- Left Hand Turning Tool – 1 Pc
- Right Hand Turning Tool – 1 Pc
- Straight Facing Tool – 1 Pc
- Right Hand Facing Tool – 1 Pc
- Roughing Tool – 1 Pc
- Parting Tool – 1 Pc

Item Code No.	Shank Size	
	Inch	mm
ABM-CT-12186	1/4	6
ABM-CT-12187	5/16	8
ABM-CT-12188	3/8	10
ABM-CT-12189	1/2	12

Carbide Brazed Turning Tools Set of 11 Pcs.

- Ideal for metal working lathe, turning, cutting & threading.
- Handle a variety of projects with this versatile lathe tool set.
- These tools are used for internal & external operation.
- With this set you can face, rough, finish both to the right and left plus parting or cutting off.
- Suitable for ordinary lathe and CNC Lathe.
- Set of 11 Pcs.
- Available in any desired Color.
- Shank Size 10 x 10 mm.
- Made from Steel and with Carbide Tip.
- Packed in attractive Wooden Box Packing.

SET CONSIST of (11 Pcs) :

- Left Hand Turning Tool – 3 Pc
- Right Hand Finishing Tool – 1 Pc
- Right Hand Turning Tool – 1 Pc
- Roughing Tool – 2 Pcs
- Chamfer – 1 Pc
- Parting Tool – 1 Pc
- Boring Bars – 2 Pc

Item Code No.
ABM-CT-12195



Carbide Brazed Turning Tools Set of 6 Pcs.

- Set of 6 Pcs.
- Packed in attractive Wooden Box Packing.

SET CONSIST of (6 Pcs) :

- 55 Degree External Threading Tool – 1 Pc
- 60 Degree External Threading Tool – 1 Pc
- 55 Degree Internal Threading Tool – 1 Pc
- 60 Degree Internal Threading Tool – 1 Pc
- Boring Tool Left – 1 Pc
- Hand Facing Tool Left – 1 Pc

Item Code No.	Shank Size	
	Inch	mm
ABM-CT-12180	1/4	6
ABM-CT-12182	5/16	8
ABM-CT-12183	3/8	10
ABM-CT-12184	1/2	12



Solid Cap Screw Counter Bore

As per DIN 373 & BS 378

- Used for Counter boring holes to suit cap screws.
- Used for making head of Screw or Bolt.
- Also used as a spot facer.
- Sets also available.
- Also available in Morse Taper Shanks.

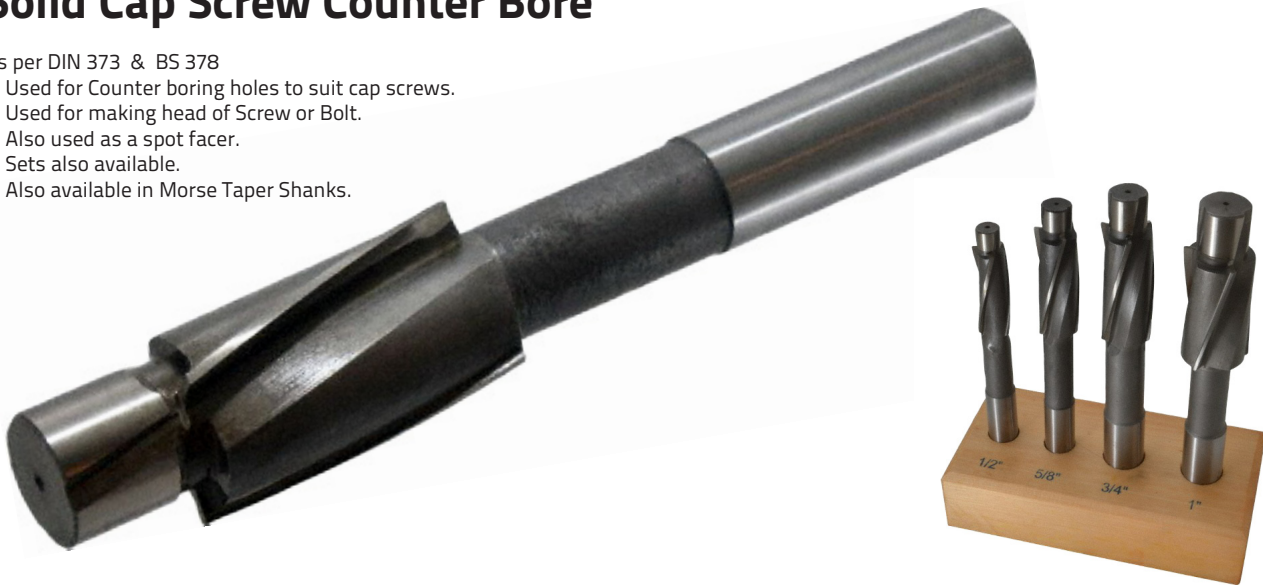

Item Code No.	Cap Screw Size	Pilot Diameter	Cutting Dia.	Shank Dia.	Overall Length
ABM-CT-13860	M 3	3.2 mm	6 mm	5 mm	71 mm
ABM-CT-13861	M 3.5	3.7 mm	6.5 mm	5 mm	71 mm
ABM-CT-13862	M 4	4.3 mm	8 mm	5 mm	71 mm
ABM-CT-13863	M 5	5.3 mm	10 mm	8 mm	80 mm
ABM-CT-13864	M 6	6.4 mm	11 mm	8 mm	80 mm
ABM-CT-13865	M 8	8.4 mm	15 mm	12.5 mm	100 mm
ABM-CT-13866	M 10	10.5 mm	18 mm	12.5 mm	100 mm
ABM-CT-13867	M 12	13 mm	20 mm	12.5 mm	100 mm
ABM-CT-13873	1/4"	9/32"	13/32"	3/8"	5"
ABM-CT-13874	5/16"	11/32"	1/2"	7/16"	5"
ABM-CT-13875	3/8"	13/32"	19/32"	1/2"	6"
ABM-CT-13876	7/16"	15/32"	11/16"	1/2"	7"
ABM-CT-13877	1/2"	17/32"	25/32"	1/2"	7-1/2"
ABM-CT-13878	5/8"	21/32"	31/32"	3/4"	7-1/2"
ABM-CT-13879	3/4"	25/32"	1-5/32"	1"	8"
ABM-CT-13880	1"	1-1/16"	1-9/16"	1"	10"

Sets also available

Adjustable Scraper & Deburring Tool

- Hardened high speed steel (HSS) blades, adjustable for best suited working length.
- Triangular Blade profile.
- Bull nose collet face serves as a non-marring edge guide.
- Good balanced, & comfortable hand grip , 4-1/2" length.

Item Code No.
ABM-EPT-10040



Countersink & Deburring Tools (Zero Flute)



- Made from High Speed Steel, Available in 82° and 90° Degree Cuts.
- Cam relieved for Chatter Free Cut, Through hole design, easy to re-sharpen.

Item Code No.	Size	Capacity Small to Large		Shank Dia.
		Inch	mm	
ABM-CT-12420	0 Double End	1/16 to 15/64	2 to 5	6 mm
ABM-CT-12421	1 Single End	5/32 to 13/32	5 to 10	8 mm
ABM-CT-12422	2 Single End	3/16 to 17/32	10 to 15	10 mm
ABM-CT-12423	3 Single End	5/16 to 25/32	15 to 20	12 mm
ABM-CT-12424	4 Single End	9/16 to 1-1/16	20 to 25	15 mm
ABM-CT-12425	Set of 5 pcs Size 0, 1, 2, 3, 4 on Wooden Stand			
Please mention 82° or 90° Degree while placing order				

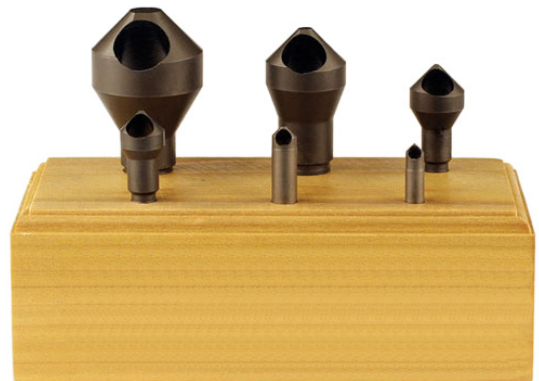

Single Flute Countersinks - HSS

- Designed for machine use and light, portable work.
- Ideal for chamfering, Deburring and Counter sinking.
- Single flute construction and low controlled relief provide chatterless operation and smooth surface finish.
- Versatility of this tool should increase productivity on all general purpose applications.
- Made from High Speed Steel.
- Available in 60°, 82°, 90° and 100° Degree.

Item Code No.	Size	Shank Dia	Overall Length
ABM-CT-12426	3/16"	3/16"	1-1/2"
ABM-CT-12427	1/4"	1/4"	2"
ABM-CT-12428	5/16"	1/4"	2"
ABM-CT-12429	3/8"	1/4"	2"
ABM-CT-12430	1/2"	1/4"	2"
ABM-CT-12431	5/8"	1/2"	2-1/4"
ABM-CT-12432	3/4"	1/2"	2-3/4"
ABM-CT-12433	7/8"	1/2"	2-3/4"
ABM-CT-12434	1"	1/2"	2-3/4"
ABM-CT-12435	1-1/4"	3/4"	3"
ABM-CT-12436	1-1/2"	3/4"	3-3/8"
ABM-CT-12437	2"	3/4"	3-3/4"
While placing order please mention 62°, 82°, 90° and 100°			



Item Code No. Sets	Range	No of Pcs.	Description
ABM-CT-12438	1/4, 3/8 & 1/2"	3	Plastic pouch
ABM-CT-12439	1/4, 3/8, 1/2, 3/4 & 1"	5	Wooden Stand
ABM-CT-12440	3/16, 1/4, 5/16, 3/8, 1/2, 5/8, 3/4, 7/8 & 1"	9	Wooden Stand
ABM-CT-12441	3/16, 1/4, 5/16, 3/8, 1/2, 5/8, 3/4, 7/8, 1, 1-1/4, 1-1/2 & 2"	12	Wooden Stand

Three Flute Countersinks - HSS

- Designed for counter Sinking holes for centers or for enlarging existing hole.
- Odd numbers of flutes eliminates chatter in most applications, while providing better accuracy than a single flute Countersink.
- Single flute construction and low controlled relief provide chatterless operation and smooth surface finish.
- Made from High Speed Steel.
- Available in 60°, 82° and 90° Degree.

Item Code No.	Size	Shank Dia	Overall Length
ABM-CT-12445	1/4"	3/16"	1-1/2"
ABM-CT-12446	3/8"	1/4"	1-3/4"
ABM-CT-12447	1/2"	3/8"	2"
ABM-CT-12448	5/8"	3/8"	2-1/4"
ABM-CT-12449	3/4"	1/2"	2-5/8"
ABM-CT-12450	1"	1/2"	2-3/4"
ABM-CT-12451	1-1/4"	3/4"	3-1/2"
ABM-CT-12452	1-1/2"	3/4"	3-1/2"
ABM-CT-12453	2"	3/4"	3-3/4"

While placing order please mention 62°, 82°, 90°

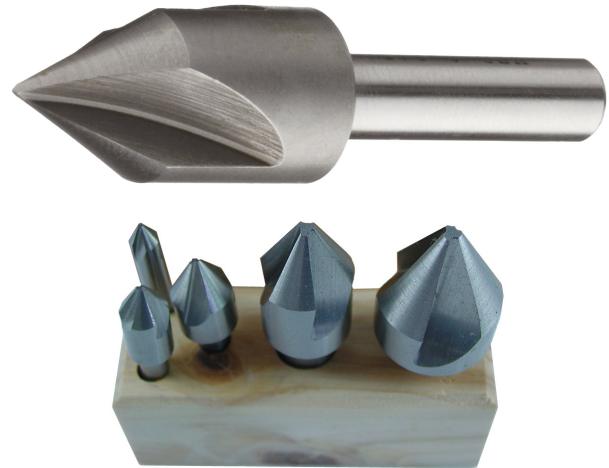

Item Code No. Sets	Range	No of Pcs.	Description
ABM-CT-12454	1/4, 3/8 & 1/2"	3	Plastic pouch
ABM-CT-12455	1/4, 3/8, 1/2, 3/4 & 1"	5	Wooden Stand
ABM-CT-12456	3/16, 1/4, 5/16, 3/8, 1/2, 5/8, 3/4, 7/8 & 1"	9	Wooden Stand
ABM-CT-12457	3/16, 1/4, 5/16, 3/8, 1/2, 5/8, 3/4, 7/8, 1, 1-1/4, 1-1/2 & 2"	12	Wooden Stand

Six Flute Countersinks

- Designed for Economical, General purpose countersinking, chamfering or Deburring.
- Chip loads are generally smaller and chatter free machining is possible.
- Shatterless countersinks are designed to give you fast shearing cuts.
- Made from High Speed Steel.
- Available in 60°, 82° and 90° Degree.

Item Code No.	Size	Shank Dia	Overall Length
ABM-CT-12460	3/16"	3/16"	1-1/2"
ABM-CT-12461	1/4"	1/4"	2"
ABM-CT-12462	5/16"	1/4"	2"
ABM-CT-12463	3/8"	1/4"	2"
ABM-CT-12464	1/2"	1/4"	2"
ABM-CT-12465	5/8"	1/2"	2-3/4"
ABM-CT-12466	3/4"	1/2"	2-3/4"
ABM-CT-12467	7/8"	1/2"	2-3/4"
ABM-CT-12468	1"	1/2"	2-3/4"
ABM-CT-12469	1-1/4"	3/4"	2-3/8"
ABM-CT-12470	1-1/2"	3/4"	3-1/2"
ABM-CT-12471	1-3/4"	1"	4-1/4"
ABM-CT-12472	2"	1"	4-3/8"

While placing order please mention 62°, 82°, 90°



Item Code No. Sets	Range	No of Pcs.	Description
ABM-CT-12475	1/4, 3/8 & 1/2"	3	Plastic pouch
ABM-CT-12476	1/4, 3/8, 1/2, 3/4 & 1"	5	Wooden Stand

Handy Burr

- High Speed Steel 3 Flutes and 6 Flutes.
- Angle of Head is 60° or 90°.
- Used for chamfering holes in panels of metal, plastic or wood or for deburring tube ends.
- Available in wooden and plastic handle.
- As per DIN 335C for 90° and DIN334C for 60°.
- Available with and without Handle

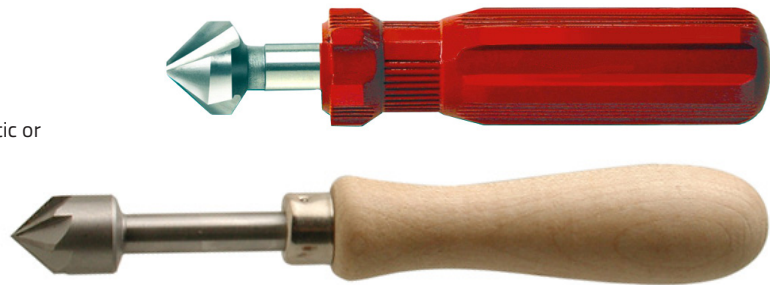

Item Code No. 60°	Item Code No. 90°	Length		Size	Shank Dia.
		60°	90°		
ABM-CT-12480	ABM-CT-12490	45 mm	45 mm	6.3 mm	5 mm
ABM-CT-12481	ABM-CT-12491	50 mm	50 mm	8 mm	6 mm
ABM-CT-12482	ABM-CT-12492	50 mm	50 mm	10 mm	6 mm
ABM-CT-12483	ABM-CT-12493	56 mm	56 mm	12.5 mm	8 mm
ABM-CT-12484	ABM-CT-12494	63 mm	60 mm	16 mm	10 mm
ABM-CT-12485	ABM-CT-12495	67 mm	63 mm	20 mm	10 mm
ABM-CT-12486	ABM-CT-12496	71 mm	67 mm	25 mm	10 mm

Combined Drill and Countersinks (Centre Drills)

- Made from HSS.
- These are designed with spiral flutes and various lengths and forms to give high quality centre holes that suits most applications.
- Used for producing Centre holes in components or Work Piece machining between centres.
- 60 Degree countersink angle fits all standard centres.
- Plain type available in 60°, 82°, 90°.
- Also available in Standard and Long lengths.

1. Part A – HSS Standard Type – Inches Plain Type – As Per ANSI B94.11M
2. Part B – HSS Standard Type – MM
3. BELL TYPE 60 Degree
4. PLAIN TYPE 60 Degree Long



PART A - HSS STANDARD TYPE -INCHES ANSI B94.11M				
Item Code No.	Size	Body Dia.	Shank Dia.	Overall Length
ABM-CT-12500	00	1/8"	0.025"	1-1/8"
ABM-CT-12501	0	1/8"	1/32"	1-1/8"
ABM-CT-12502	1	1/8"	3/64"	1-1/4"
ABM-CT-12503	2	3/16"	5/64"	1-7/8"
ABM-CT-12504	3	1/4"	7/64"	2"
ABM-CT-12505	4	5/16"	1/8"	2-1/8"
ABM-CT-12506	4-1/2	3/8"	9/64"	2-1/2"
ABM-CT-12507	5	7/16"	3/16"	2-3/4"
ABM-CT-12508	6	1/2"	7/32"	3"
ABM-CT-12509	7	5/8"	1/4"	3-1/4"
ABM-CT-12510	8	3/4"	5/16"	3-1/2"
ABM-CT-12511	9	7/8"	11/32"	3-5/8"
ABM-CT-12512	10	1"	3/8"	3-3/4"

While placing order please mention 62°, 82°, 90°

PART B - HSS STANDARD TYPE -MM			
Item Code No.	Size	Shank Dia.	Overall Length
ABM-CT-12520	3.15	1.00	31.5
ABM-CT-12521	3.15	1.25	31.5
ABM-CT-12522	4.00	1.60	35.5
ABM-CT-12523	5.00	2.00	40.0
ABM-CT-12524	6.30	2.50	45.0
ABM-CT-12525	8.00	3.15	50.0
ABM-CT-12526	10.00	4.00	56.0
ABM-CT-12527	12.50	5.00	63.0
ABM-CT-12528	16.00	6.30	71.0
ABM-CT-12529	20.00	8.00	83.0
ABM-CT-12530	25.00	10.00	103.0

While placing order please mention 62°, 82°, 90°



Cutting Tools

BELL TYPE 60 DEGREE					
Item Code No. Bell Type 60°	Size	Body Dia.	Drill Dia.	Bell Dia.	Overall Length
ABM-CT-14030	11	1/8"	0.025"	1-1/8"	1-1/8"
ABM-CT-14031	12	1/8"	1/32"	1-1/8"	1-1/8"
ABM-CT-14032	13	1/8"	3/64"	1-1/4"	1-1/4"
ABM-CT-14033	14	3/16"	5/64"	1-7/8"	1-7/8"
ABM-CT-14034	15	1/4"	7/64"	2"	2"
ABM-CT-14035	16	5/16"	1/8"	2-1/8"	2-1/8"
ABM-CT-14036	17	3/8"	9/64"	2-1/2"	2-1/2"
ABM-CT-14037	18	7/16"	3/16"	2-3/4"	2-3/4"
ABM-CT-14038	Set of 5 Pcs from Size 11 to Size 15				
While placing order please mention 62°, 82°, 90°					

PLAIN TYPE 60 DEGREE LONG				
Item Code No.	Size	Body Dia.	Shank Dia.	Overall Length
ABM-CT-14050	1	1/8"	3/64"	3"
ABM-CT-14051	1	1/8"	3/64"	4"
ABM-CT-14052	1	1/8"	3/64"	5"
ABM-CT-14053	1	1/8"	3/64"	6"
ABM-CT-14054	2	3/16"	5/64"	3"
ABM-CT-14055	2	3/16"	5/64"	4"
ABM-CT-14056	2	3/16"	5/64"	5"
ABM-CT-14057	2	3/16"	5/64"	6"
ABM-CT-14058	3	1/4"	7/64"	4"
ABM-CT-14059	3	1/4"	7/64"	5"
ABM-CT-14060	3	1/4"	7/64"	6"
ABM-CT-14061	4	5/16"	1/8"	4"
ABM-CT-14062	4	5/16"	1/8"	5"
ABM-CT-14063	4	5/16"	1/8"	6"
ABM-CT-14064	5	7/16"	3/16"	4"
ABM-CT-14065	5	7/16"	3/16"	5"
ABM-CT-14066	5	7/16"	3/16"	6"
ABM-CT-14067	6	1/2"	7/32"	4"
ABM-CT-14068	6	1/2"	7/32"	5"
ABM-CT-14069	6	1/2"	7/32"	6"
ABM-CT-14070	7	5/8"	1/4"	6"
ABM-CT-14071	8	3/4"	5/16"	6"
While placing order please mention 62°, 82°, 90°				

Cut Of Blades (Parting Tool Bits)

- Available in HSS M2 Quality (Single H), M-35 Quality (5% Cobalt) (Double H), M42 Quality (8% Cobalt) (Triple H), T-42 Quality (10% Cobalt) (Special H).
- Also available in mm sizes.

M 2 Quality Item Code No.	M 35 Quality Item Code No.	M 42 Quality Item Code No.	T 42 Quality Item Code No.	Size in Inches
ABM-CT-12735	ABM-CT-12755	ABM-CT-12768	ABM-CT-12784	1/16 x 5/16 x 3-1/2
ABM-CT-12736	ABM-CT-12756	ABM-CT-12769	ABM-CT-12785	3/32 x 1/2 x 4
ABM-CT-12737	ABM-CT-12757	ABM-CT-12770	ABM-CT-12786	3/32 x 1/2 x 4-1/2
ABM-CT-12738	ABM-CT-12758	ABM-CT-12771	ABM-CT-12787	3/32 x 5/8 x 5
ABM-CT-12739	ABM-CT-12759	ABM-CT-12772	ABM-CT-12788	1/8 x 3/4 x 6
ABM-CT-12740	ABM-CT-12760	ABM-CT-12773	ABM-CT-12789	1/8 x 7/8 x 6
ABM-CT-12741	ABM-CT-12761	ABM-CT-12774	ABM-CT-12790	1/8 x 7/8 x 7
ABM-CT-12742	ABM-CT-12762	ABM-CT-12775	ABM-CT-12791	1/8 x 1 x 8
ABM-CT-12743	ABM-CT-12763	ABM-CT-12776	ABM-CT-12792	3/16 x 3/4 x 6
ABM-CT-12744	ABM-CT-12764	ABM-CT-12777	ABM-CT-12793	3/16 x 1 x 6
ABM-CT-12745	ABM-CT-12765	ABM-CT-12778	ABM-CT-12794	3/16 x 1 x 6-1/2
ABM-CT-12746	ABM-CT-12766	ABM-CT-12779	ABM-CT-12795	3/16 x 1-1/8 x 6
ABM-CT-12747	ABM-CT-12767	ABM-CT-12780	ABM-CT-12796	3/16 x 1 x 8



Tool Bits (Square, Round and Rectangular Tool Bits)



- Available in HSS M2 Quality (Single H), M-35 Quality (5% Cobalt) (Double H), M42 Quality (8% Cobalt) (Triple H), T-42 Quality (10% Cobalt) (Special H).

ROUND TOOL BITS			SQUARE TOOL BITS			RECTANGULAR TOOL BITS	
Item Code No.	Size		Item Code No.	Size		Item Code No.	Inch
	MM	Inches		MM	Inches		
ABM-CT-12800	2.5 x 75	3/32 x 3	ABM-CT-12840	2.5 x 75	3/32 x 3	ABM-CT-12890	1/8" X 1/2 x 6
ABM-CT-12801	2.5 x 100	3/32 x 4	ABM-CT-12841	2.5 x 100	3/32 x 4	ABM-CT-12891	1/8 x 1/2 x 8
ABM-CT-12802	3 x 75	1/8 x 3	ABM-CT-12842	3 x 75	1/8 x 3	ABM-CT-12892	1/8 x 3/4 x 6
ABM-CT-12803	3 x 100	1/8 x 4	ABM-CT-12843	3 x 100	1/8 x 4	ABM-CT-12893	1/8 x 3/4 x 8
ABM-CT-12804	4 x 75	5/32 x 3	ABM-CT-12844	4 x 75	5/32 x 3	ABM-CT-12894	1/8 x 1 x 6
ABM-CT-12805	4 x 100	5/32 x 4	ABM-CT-12845	4 x 100	5/32 x 4	ABM-CT-12895	1/8 x 1 x 8
ABM-CT-12806	5 x 75	3/16 x 3	ABM-CT-12846	5 x 75	3/16 x 3	ABM-CT-12896	3/16 x 1/2 x 6
ABM-CT-12807	5 x 100	3/16 x 4	ABM-CT-12847	5 x 100	3/16 x 4	ABM-CT-12897	3/16 x 1/2 x 8
ABM-CT-12808	5 x 150	3/16 x 6	ABM-CT-12848	5 x 150	3/16 x 6	ABM-CT-12898	3/16 x 3/4 x 8
ABM-CT-12809	6 x 75	1/4 x 3	ABM-CT-12849	6 x 75	1/4 x 3	ABM-CT-12899	3/16 x 1 x 8
ABM-CT-12810	6 x 100	1/4 x 4	ABM-CT-12850	6 x 100	1/4 x 4	ABM-CT-12900	1/4 x 1/2 x 8
ABM-CT-12811	6 x 150	1/4 x 6	ABM-CT-12851	6 x 150	1/4 x 6	ABM-CT-12901	1/4 x 3/4 x 8
ABM-CT-12812	8 x 75	5/16 x 3	ABM-CT-12852	8 x 75	5/16 x 3	ABM-CT-12902	1/4 x 1 x 6
ABM-CT-12813	8 x 100	5/16 x 4	ABM-CT-12853	8 x 100	5/16 x 4	ABM-CT-12903	1/4 x 1 x 8
ABM-CT-12814	8 x 150	5/16 x 6	ABM-CT-12854	8 x 150	5/16 x 6	ABM-CT-12904	5/16 x 3/4 x 8
ABM-CT-12815	10 x 75	3/8 x 3	ABM-CT-12855	10 x 75	3/8 x 3	ABM-CT-12905	3/8 x 1/2 x 8
ABM-CT-12816	10 x 100	3/8 x 4	ABM-CT-12856	10 x 100	3/8 x 4	ABM-CT-12906	3/8 x 5/8 x 8
ABM-CT-12817	10 x 150	3/8 x 6	ABM-CT-12857	10 x 150	3/8 x 6	ABM-CT-12907	3/8 x 3/4 x 8
ABM-CT-12818	12 x 75	1/2 x 3	ABM-CT-12858	12 x 75	1/2 x 3	ABM-CT-12908	3/8 x 1 x 6
ABM-CT-12819	12 x 100	1/2 x 4	ABM-CT-12859	12 x 100	1/2 x 4	ABM-CT-12909	3/8 x 1 x 8
ABM-CT-12820	12 x 150	1/2 x 6	ABM-CT-12860	12 x 150	1/2 x 6	ABM-CT-12910	1/2 x 5/8 x 6
ABM-CT-12821	16 x 100	5/8 x 4	ABM-CT-12861	16 x 100	5/8 x 4	ABM-CT-12911	1/2 x 5/8 x 8
ABM-CT-12822	16 x 150	5/8 x 6	ABM-CT-12862	16 x 150	5/8 x 6	ABM-CT-12912	1/2 x 3/4 x 6
ABM-CT-12823	16 x 200	5/8 x 8	ABM-CT-12863	16 x 200	5/8 x 8	ABM-CT-12913	1/2 x 3/4 x 8
ABM-CT-12824	20 x 100	3/4 x 4	ABM-CT-12864	20 x 100	3/4 x 4	ABM-CT-12914	1/2 x 1 x 6
ABM-CT-12825	20 x 150	3/4 x 6	ABM-CT-12865	20 x 150	3/4 x 6	ABM-CT-12915	1/2 x 1 x 8
ABM-CT-12826	20 x 200	3/4 x 8	ABM-CT-12866	20 x 200	3/4 x 8	ABM-CT-12916	5/8 x 3/4 x 6
ABM-CT-12827	25 x 100	1 x 4	ABM-CT-12867	25 x 100	1 x 4	ABM-CT-12917	5/8 x 3/4 x 8
ABM-CT-12828	25 x 150	1 x 6	ABM-CT-12868	25 x 150	1 x 6	ABM-CT-12918	3/4 x 1 x 6
ABM-CT-12829	25 x 200	1 x 8	ABM-CT-12869	25 x 200	1 x 8	ABM-CT-12919	3/4 x 1 x 8

While placing order Please mention HSS M2, M35, M42 or T42 quality

Hand Taps (Carbon Steel & HSS)



- Manufactured from Carbon Steel and HSS.
- Precisely Hardened and Tempered for long Life.
- All Taps are right hand.
- Left Hand Taps also available.
- Packed as set of 3 Pcs (Taper Tap, Second Tap and Bottoming Tap).
- Also available in BSF, UNF, UNC, BSP, BA, BSPT and NPT Threads.
- Machine Taps also available.

MM SIZE - Thread Angle 60°			
Carbon Steel Item Code No.	HSS Item Code No.	Size mm	Thread Per Pitch
ABM-CT-12540	ABM-CT-12590	2.0	0.40
ABM-CT-12541	ABM-CT-12591	2.5	0.45
ABM-CT-12542	ABM-CT-12592	2.6	0.45
ABM-CT-12543	ABM-CT-12593	3.0	0.50
ABM-CT-12544	ABM-CT-12594	3.5	0.60
ABM-CT-12545	ABM-CT-12595	4.0	0.70
ABM-CT-12546	ABM-CT-12596	4.5	0.75
ABM-CT-12547	ABM-CT-12597	5.0	0.80
ABM-CT-12548	ABM-CT-12598	5.5	0.90
ABM-CT-12549	ABM-CT-12599	6.0	1.00
ABM-CT-12550	ABM-CT-12600	7.0	1.00
ABM-CT-12551	ABM-CT-12601	8.0	1.25
ABM-CT-12552	ABM-CT-12602	9.0	1.25
ABM-CT-12553	ABM-CT-12603	10.0	1.50
ABM-CT-12554	ABM-CT-12604	11.0	1.50
ABM-CT-12555	ABM-CT-12605	12.0	1.75
ABM-CT-12556	ABM-CT-12606	13.0	1.75
ABM-CT-12557	ABM-CT-12607	14.0	2.00
ABM-CT-12558	ABM-CT-12608	15.0	2.00
ABM-CT-12559	ABM-CT-12609	16.0	2.00
ABM-CT-12560	ABM-CT-12610	18.0	2.50
ABM-CT-12561	ABM-CT-12611	20.0	2.50
ABM-CT-12562	ABM-CT-12612	22.0	2.50
ABM-CT-12563	ABM-CT-12613	24.0	3.00
ABM-CT-12564	ABM-CT-12614	27.0	3.00
ABM-CT-12565	ABM-CT-12615	30.0	3.50
ABM-CT-12566	ABM-CT-12616	33.0	3.50
ABM-CT-12567	ABM-CT-12617	36.0	4.00
ABM-CT-12568	ABM-CT-12618	39.0	4.00
ABM-CT-12569	ABM-CT-12619	41.0	4.50
ABM-CT-12570	ABM-CT-12620	45.0	4.50
ABM-CT-12571	ABM-CT-12621	48.0	5.00
ABM-CT-12572	ABM-CT-12622	52.0	5.00
ABM-CT-12573	ABM-CT-12623	56.0	5.50
ABM-CT-12574	ABM-CT-12624	60.0	5.50

Also available in BSF, UNF, UNC, BSP, BA, BSPT and NPT Threads
While placing order please mention Carbon Steel or HSS

INCHES SIZE- Thread Angle 55° (BSW)			
Carbon Steel Item Code No.	HSS Item Code No.	Size Inches	Thread Per Pitch - BSW
ABM-CT-12640	ABM-CT-12690	1/16"	60
ABM-CT-12641	ABM-CT-12691	3/32"	48
ABM-CT-12642	ABM-CT-12692	1/8"	40
ABM-CT-12643	ABM-CT-12693	5/32"	32
ABM-CT-12644	ABM-CT-12694	3/16"	24
ABM-CT-12645	ABM-CT-12695	7/32"	24
ABM-CT-12646	ABM-CT-12696	1/4"	20
ABM-CT-12647	ABM-CT-12697	9/32"	20
ABM-CT-12648	ABM-CT-12698	5/16"	18
ABM-CT-12649	ABM-CT-12699	3/8"	16
ABM-CT-12650	ABM-CT-12700	7/16"	14
ABM-CT-12651	ABM-CT-12701	1/2"	12
ABM-CT-12652	ABM-CT-12702	9/16"	12
ABM-CT-12653	ABM-CT-12703	5/8"	11
ABM-CT-12654	ABM-CT-12704	11/16"	11
ABM-CT-12655	ABM-CT-12705	3/4"	10
ABM-CT-12656	ABM-CT-12706	13/16"	10
ABM-CT-12657	ABM-CT-12707	7/8"	9
ABM-CT-12658	ABM-CT-12708	15/16"	9
ABM-CT-12659	ABM-CT-12709	1"	8
ABM-CT-12660	ABM-CT-12710	1-1/8"	7
ABM-CT-12661	ABM-CT-12711	1-1/4"	7
ABM-CT-12662	ABM-CT-12712	1-3/8"	6
ABM-CT-12663	ABM-CT-12713	1-1/2"	6
ABM-CT-12664	ABM-CT-12714	1-5/8"	5
ABM-CT-12665	ABM-CT-12715	1-3/4"	5
ABM-CT-12666	ABM-CT-12716	1-7/8"	4-1/2"
ABM-CT-12667	ABM-CT-12717	2"	4-1/2"
ABM-CT-12668	ABM-CT-12718	2-1/4"	4
ABM-CT-12669	ABM-CT-12719	2-1/2"	4
ABM-CT-12670	ABM-CT-12720	2-3/4"	3-1/2"
ABM-CT-12671	ABM-CT-12721	3"	3-1/2"
ABM-CT-12672	ABM-CT-12722	3-1/4"	3-1/4"
ABM-CT-12673	ABM-CT-12723	3-1/2"	3-1/4"
ABM-CT-12674	ABM-CT-12724	3-3/4"	3"
ABM-CT-12675	ABM-CT-12725	4"	3"

Also available in BSF, UNF, UNC, BSP, BA, BSPT and NPT Threads
While placing order please mention Carbon Steel or HSS

Round & Hex Dies

(Carbon Steel and HSS Quality)

- Used for manual use of die holders or clamped into the quill to use in a turning lathe.
- Hex Dies Also available.
- Available in HSS and Carbon Steel.
- available in BSW, METRIC, BSF, UNF, UNC, BSP, BA, BSPT and NPT Threads.
- With accurately cut thread.



Hex Dies



Carbon Steel Item Code No.	HSS Item Code No.	Size	Outer Dia in Inches
ABM-CT-12950	ABM-CT-12970	1/16", 3/32" BSW, 0 NC to 10 NC, 0 NF to 10 NF, 6 BA to 10 BA, 2mm, 2.5, 2.6 mm	13/16" OD
ABM-CT-12951	ABM-CT-12971	1/8", 5/32", 3/16", 1/4" BSW, BSF, UNF, UNC, 3mm, 3.5, 4, 5, 6 mm, 0 to 5 BA	13/16" OD
ABM-CT-12952	ABM-CT-12972	5/32, 3/16, 7/32, 1/4, 9/32, 5/16, 3/8 BSW, BSF, UNF, 4mm to 10 mm, 1/8 BSP / NPT / BSPT	1" OD
ABM-CT-12953	ABM-CT-12973	3/8" to 3/4" BSW, BSF, UNF, UNC, 10 mm to 18 mm, 1/4, 3/8 BSP / NPT / BSPT	1-1/2" OD
ABM-CT-12954	ABM-CT-12974	3/4" to 1" BSW, BSF, UNF, UNC, 18 mm TO 28 mm, 1/2, 3/4 BSP / NPT / BSPT	2" OD
ABM-CT-12955	ABM-CT-12975	1-1/8", 1-1/4" BSW, BSF, UNF, 28 mm to 33 mm, 1" BSP / NPT / BSPT	2-1/4" OD
ABM-CT-12956	ABM-CT-12976	1-1/4" BSW, BSF, UNF, 34 mm, 35 mm, 36 mm 1" BSP / NPT / BSPT	2-1/2" OD
ABM-CT-12957	ABM-CT-12977	1-1/2" BSW, BSF, NF, 36 mm to 46 mm, 1-1/4" BSP / NPT / BSPT	3" OD
ABM-CT-12958	ABM-CT-12978	1-3/4", 2" BSW / BSF, 42 mm to 50 mm, 1-1/2" BSP / NPT / BSPT	4" OD

While placing order please mention Hex Dies or Round Dies

Conduit Die Set



- Made from fine quality tool steel.
- Stocks & Dies made from high quality steel for longer life.

Item Code No.	Set Contents
ABM-IMT-8260	M20, M25
ABM-IMT-8261	M20, M25 & M32



Die Adapters

- Easily converts round die into hex dies.
- Just set the correct size die into adapter and tighten the screw.
- Great tool to use where conventional die stocks cannot swing due to lack of space.

Item Code No.	Size of Cutter
ABM-IMT-6739	13/16"
ABM-IMT-6740	1"
ABM-IMT-6741	1-1/2"
ABM-IMT-6742	2"
ABM-IMT-6743	2-1/2"
ABM-IMT-6744	3"
ABM-IMT-6745	Set of 4 pcs consisting of 13/16", 1", 1-1/2", 2"



Tap & Round Die Sets - Complete (Packed in Fine Finished Wooden Boxes)



MM - BA - BSW - BSP - NPT - BSPT

Item Code No.	Range of Sizes - One Set each of Taps & One Piece of Round Die in Suitable Dia	Round Die Handle (Circular Die Stock) Outer Diameter						Tap Handle (Tap Wrench)	No of Sizes
		13/16"	1"	1-1/2"	2"	2-1/4"	3"		
ABM-CT-13920	2, 3, 4, 5, 6 MM	2 to 6	--	--	--	--	--	1/4	5
ABM-CT-13921	2, 3, 4, 5, 6, 7, 8, 9, 10 MM	2 to 6	7 to 10	--	--	--	--	1/2	9
ABM-CT-13922	6, 7, 8, 10, 12 MM	--	6 to 10	12 MM	--	--	--	1/2	5
ABM-CT-13923	6, 8, 10, 12, 14, 16, 18 MM	--	6 to 10	12 to 18	--	--	--	3/4	7
ABM-CT-13924	6, 8, 10, 12, 14, 16, 18, 20 MM	--	6 to 10	12 to 20	--	--	--	3/4	8
ABM-CT-13925	6, 8, 10, 12, 14, 16, 18, 20, 22, 24 MM	--	--	12 to 18	20 to 24	--	--	12 & 1	10
ABM-CT-13926	6, 8, 10, 12, 14, 16, 18, 20, 22, 24, 26, 28, 30 MM	--	--	6 to 18	20 to 24	26 to 30	--	1/2 & 1-1/4	13
ABM-CT-13927	0, 1, 2, 3, 4, 5, 6 BA	0 to 6 BA	--	--	--	--	--	1/4	7
ABM-CT-13928	0, 1, 2, 3, 4, 5, 6, 7, 8 BA	0 to 8 BA	--	--	--	--	--	1/4	9
ABM-CT-13929	0, 1, 2, 3, 4, 5, 6, 7, 8, 9, 10 BA	0 to 10 BA	--	--	--	--	--	1/4	11
ABM-CT-13930	1/4, 5/16, 3/8, 7/16, 1/2, 5/8, 3/4, 7/8, 1, 1-1/8, 1-1/4, BSW	--	--	1/4 to 3/4	--	7/8 to 1-1/4	--	1/2 & 1-1/4	11
ABM-CT-13931	1/4, 5/16, 3/8, 7/16, 1/2, 5/8, 3/4, 7/8, 1, 1-1/8, 1-1/4, 1-1/2 BSW	--	--	1/4 to 3/4	--	7/8 to 1-1/4	1-1/2	1/2 & 1-1/2	12
ABM-CT-13932	1/8, 1/4, 3/8, 1/2, 3/4, 1 BSP	--	--	1/8 to 3/8	1/2 to 3/4	1	--	3/4 & 1-1/2	6
ABM-CT-13933	1/8, 1/4, 3/8, 1/2, 5/8, 3/4, 7/8, 1, 1-1/4 BSP	--	--	1/8 to 3/8	1/2 to 3/4	--	7/8 to 1-1/4	1 & 1-1/2	9
ABM-CT-13934	1/8, 1/4, 3/8, 1/2, 5/8, 3/4, 7/8, 1, 1-1/4, 1-1/2 BSP	--	--	1/8 to 3/8	1/2 to 3/4	--	7/8 to 1-1/2	1 & 2	10
ABM-CT-13935	1/8, 1/4, 3/8, 1/2, 3/4, 1, 1-1/4, 1-1/2 BSP	--	--	1/8 to 3/8	1/2 to 3/4	--	1 to 1-1/2	1 & 2	8
ABM-CT-13936	1/8, 1/4, 3/8, 1/2, 3/4, 1 NPT Tap will be one piece bottom only	--	--	1/8 to 3/8	--	1/2 to 1	--	3/4 & 1-1/2	6
ABM-CT-13937	1/8, 1/4, 3/8, 1/2, 3/4, 1 BSPT Tap will be one piece bottom only	--	--	1/8 to 3/8	--	1/2 to 1	--	3/4 & 1-1/2	6

BSW - BSF - UNF - UNC

Item Code No.	Range of Sizes - One Set each of Taps & One Piece of Round Die in Suitable Dia	Round Die Handle (Circular Die Stock) Outer Diameter				Tap Handle (Tap Wrench)	No of Sizes
		13/16"	1"	1-1/2"	2"		
ABM-CT-13900	1/16, 3/32, 1/8, 5/32, 3/16, 7/32, 1/4 BSW	1/16 to 1/4	--	--	--	1/4	7
ABM-CT-13901	1/8, 5/32, 3/16, 7/32, 1/4 BSW	1/8 to 1/4	--	--	--	1/4	5
ABM-CT-13902	1/4, 5/16, 3/8, 7/16, 1/2 BSW	--	1/4 to 3/8	7/16 to 1/2	--	1/2	5
ABM-CT-13903	1/4, 5/16, 3/8, 7/16, 1/2 BSF	--	1/4 to 3/8	7/16 to 1/2	--	1/2	5
ABM-CT-13904	1/4, 5/16, 3/8, 7/16, 1/2 UNF	--	1/4 to 3/8	7/16 to 1/2	--	1/2	5
ABM-CT-13905	1/4, 5/16, 3/8, 7/16, 1/2 UNC	--	1/4 to 3/8	7/16 to 1/2	--	1/2	5
ABM-CT-13906	1/4, 5/16, 3/8, 7/16, 1/2, 5/8, 3/4 BSW	--	1/4 to 3/8	7/16 to 3/4	--	3/4	7
ABM-CT-13907	1/4, 5/16, 3/8, 7/16, 1/2, 5/8, 3/4 BSF	--	1/4 to 3/8	7/16 to 3/4	--	3/4	7
ABM-CT-13908	1/4, 5/16, 3/8, 7/16, 1/2, 5/8, 3/4 UNF	--	1/4 to 3/8	7/16 to 3/4	--	3/4	7
ABM-CT-13909	1/4, 5/16, 3/8, 7/16, 1/2, 5/8, 3/4 UNC	--	1/4 to 3/8	7/16 to 3/4	--	3/4	7
ABM-CT-13910	1/4, 5/16, 3/8, 7/16, 1/2, 5/8, 3/4, 7/8, 1 BSW	--	1/4 to 3/8	7/16 to 3/4	7/8 to 1	1/2 & 1	9
ABM-CT-13911	1/4, 5/16, 3/8, 7/16, 1/2, 5/8, 3/4, 7/8, 1 BSF	--	1/4 to 3/8	7/16 to 3/4	7/8 to 1	1/2 & 1	9
ABM-CT-13912	1/4, 5/16, 3/8, 7/16, 1/2, 5/8, 3/4, 7/8, 1 UNF	--	1/4 to 3/8	7/16 to 3/4	7/8 to 1	1/2 & 1	9
ABM-CT-13913	1/4, 5/16, 3/8, 7/16, 1/2, 5/8, 3/4, 7/8, 1 UNC	--	1/4 to 3/8	7/16 to 3/4	7/8 to 1	1/2 & 1	9

Indexable End Mills

TPKN Inserts



- Supplied with 2 Fitted Inserts, Screws & Wrench
- Manufactured from High Grade Steel
- Excellent Tool for facing off excessive material quickly ensuring smooth and even finish.

Item Code No.	No. of Flutes	Shank	Head Dia.	Insert	Drawbar
ABM-IMT-8145	2	R8	30	TPKN1603	7/16"UNF
ABM-IMT-8146	2	MT2	25	TPKN1603	M10
ABM-IMT-8147	2	MT3	30	TPKN1603	M12
ABM-IMT-8148	2	20 mm ST.	25	TPKN1603	--
ABM-IMT-8149	2	20 mm ST.	32	TPKN1603	--
ABM-IMT-8150	3	MT2	50	TPKN1603	M10
ABM-IMT-8151	3	MT3	50	TPKN1603	M12
ABM-IMT-8152	3	MT3	60	TPKN1603	M12
ABM-IMT-8153	3	ISO30	50	TPKN1603	M12
ABM-IMT-8154	3	ISO30	60	TPKN1603	M12

Indexable End Mills

ST & MT Shanks



- Supplied with 2 Fitted Inserts, Screws & Wrench
- Manufactured from High Grade Steel
- Excellent Tool for facing off excessive material quickly ensuring smooth and even finish.

MT Shank Item Code No.	Shank	Head Dia.	No of Flutes	DrawBar
ABM-IMT-8130	MT2	25 mm	2	M10
ABM-IMT-8131	MT3	32 mm	2	M12

Straight Shank Item Code No.	Shank	Shank Dia.	Head Dia.	No. of Flutes
ABM-IMT-8135	Straight	20 mm	25 mm	2
ABM-IMT-8136	Straight	20 mm	32 mm	2

Indexable End Mills

APKT Inserts

- Supplied with 2 Fitted Inserts, Screws & Wrench
- Manufactured from High Grade Steel
- Excellent Tool for facing off excessive material quickly ensuring smooth and even finish.

Item Code No.	No. of Flutes	Shank	Head Dia.	Insert	Draw-bar
ABM-IMT-8170	3	MT2	20	APKT 100305	M10
ABM-IMT-8171	3	MT2	25	APKT 100305	M10
ABM-IMT-8172	3	MT3	25	APKT 100305	M12
ABM-IMT-8173	3	MT3	40	APKT 100305	M12



End Mill Cutters (Single End)

- End Mill Cutters (Single End) are available in HSS M2, HSS M35 (5% Cobalt) and HSS M42 (8% Cobalt)
- With Centre Cutting and without Centre Cutting.
- Also available in MM series.
- Threaded End Mills Also available.



4 Flute



2 Flute



Sets



End Mill Cutter - 2 Flutes				
2 Flutes Item Code No.	Size	Shank Dia.	Flute length	Overall Length
ABM-CT-13640	1/8"	3/8"	3/8"	2-5/16"
ABM-CT-13641	3/16"	3/8"	7/16"	2-5/16"
ABM-CT-13642	1/4"	3/8"	1/2"	2-5/16"
ABM-CT-13643	5/16"	3/8"	9/16"	2-5/16"
ABM-CT-13644	3/8"	3/8"	9/16"	2-5/16"
ABM-CT-13645	7/16"	3/8"	13/16"	2-1/2"
ABM-CT-13646	1/2"	3/8"	13/16"	2-1/2"
ABM-CT-13647	1/2"	1/2"	1"	3"
ABM-CT-13648	9/16"	1/2"	1-1/8"	3-1/8"
ABM-CT-13649	5/8"	1/2"	1-1/8"	3-1/8"
ABM-CT-13650	5/8"	5/8"	1-5/16"	3-7/16"
ABM-CT-13651	11/16"	1/2"	1-5/16"	3-5/16"
ABM-CT-13652	11/16"	5/8"	1-5/16"	3-7/16"
ABM-CT-13653	3/4"	1/2"	1-5/16"	3-5/16"
ABM-CT-13654	3/4"	5/8"	1-5/16"	3-7/16"
ABM-CT-13655	3/4"	3/4"	1-5/16"	3-9/16"

End Mill Cutter - 4, 6 & 8 Flutes					
Multiple Flutes Item Code No.	Size	Shank Dia.	Flute length	Overall Length	No of Flutes
ABM-CT-13680	1/8"	3/8"	3/8"	2-5/16"	4
ABM-CT-13681	3/16"	3/8"	1/2"	2-3/8"	4
ABM-CT-13682	1/4"	3/8"	5/8"	2-7/16"	4
ABM-CT-13683	5/16"	3/8"	3/4"	2-1/2"	4
ABM-CT-13684	3/8"	3/8"	3/4"	2-1/2"	4
ABM-CT-13685	7/16"	3/8"	1"	2-11/16"	4
ABM-CT-13686	1/2"	3/8"	1"	2-11/16"	4
ABM-CT-13687	1/2"	1/2"	1-1/4"	3-1/4"	4
ABM-CT-13688	9/16"	1/2"	1-3/8"	3-3/8"	4
ABM-CT-13689	5/8"	1/2"	1-3/8"	3-3/8"	4
ABM-CT-13690	5/8"	5/8"	1-5/8"	3-3/4"	4
ABM-CT-13691	11/16"	1/2"	1-5/8"	3-5/8"	4
ABM-CT-13692	11/16"	5/8"	1-5/8"	3-3/4"	4
ABM-CT-13693	3/4"	1/2"	1-5/8"	3-5/8"	4
ABM-CT-13694	3/4"	5/8"	1-5/8"	3-3/4"	4
ABM-CT-13695	3/4"	3/4"	1-5/8"	3-7/8"	4

End Mill Cutter - 2 Flutes				
2 Flutes Item Code No.	Size	Shank Dia.	Flute length	Overall Length
ABM-CT-13656	13/16"	3/4"	1-1/2"	3-3/4"
ABM-CT-13657	7/8"	5/8"	1-1/2"	3-5/8"
ABM-CT-13658	7/8"	3/4"	1-1/2"	3-3/4"
ABM-CT-13659	7/8"	7/8"	1-1/2"	3-3/4"
ABM-CT-13660	15/16"	3/4"	1-1/2"	3-3/4"
ABM-CT-13661	1"	1/2"	1-1/2"	3-5/8"
ABM-CT-13662	1"	5/8"	1-1/2"	3-5/8"
ABM-CT-13663	1"	3/4"	1-1/2"	3-3/4"
ABM-CT-13664	1"	1"	1-5/8"	4-1/8"
ABM-CT-13665	1-1/16"	3/4"	1-5/8"	3-7/8"
ABM-CT-13666	1-1/8"	3/4"	1-5/8"	3-7/8"
ABM-CT-13667	1-3/16"	3/4"	1-5/8"	3-7/8"
ABM-CT-13668	1-1/4"	3/4"	1-5/8"	3-7/8"
ABM-CT-13669	1-1/4"	1"	1-5/8"	4-1/8"
ABM-CT-13730	1-1/4"	1-1/4"	1-5/8"	4-1/8"
ABM-CT-13731	1-5/16"	3/4"	1-5/8"	3-7/8"
ABM-CT-13732	1-3/8"	3/4"	1-5/8"	4-1/8"
ABM-CT-13733	1-3/8"	1"	1-5/8"	4-1/8"
ABM-CT-13734	1-7/16"	3/4"	1-5/8"	4-1/8"
ABM-CT-13735	1-1/2"	3/4"	1-5/8"	4-1/8"
ABM-CT-13736	1-1/2"	1"	1-5/8"	4-1/8"
ABM-CT-13737	1-1/2"	1-1/4"	1-5/8"	4-1/8"
ABM-CT-13738	1-5/8"	3/4"	1-5/8"	4-1/8"
ABM-CT-13739	1-5/8"	1-1/4"	1-5/8"	4-1/8"
ABM-CT-13740	1-3/4"	3/4"	1-5/8"	4-1/8"
ABM-CT-13741	1-3/4"	1-1/4"	1-5/8"	4-1/8"
ABM-CT-13742	1-7/8"	1-1/4"	1-5/8"	4-1/8"
ABM-CT-13743	2"	3/4"	1-5/8"	4-1/8"
ABM-CT-13744	2"	1-1/4"	1-5/8"	4-1/8"

While placing order please mention Material M2, M35 and M42.
Also mention with or without Centre Cutting

End Mill Cutter - 4, 6 & 8 Flutes					
Multiple Flutes Item Code No.	Size	Shank Dia.	Flute length	Overall Length	No of Flutes
ABM-CT-13696	13/16"	3/4"	1-7/8"	4"	4
ABM-CT-13697	7/8"	5/8"	1-7/8"	4"	6
ABM-CT-13698	7/8"	3/4"	1-7/8"	4"	6
ABM-CT-13699	7/8"	7/8"	1-7/8"	4"	6
ABM-CT-13700	15/16"	3/4"	1-7/8"	4"	6
ABM-CT-13701	1"	1/2"	1-7/8"	4"	6
ABM-CT-13702	1"	5/8"	1-7/8"	4"	6
ABM-CT-13703	1"	3/4"	1-7/8"	4-1/8"	6
ABM-CT-13704	1"	3/4"	1-7/8"	4-1/8"	6
ABM-CT-13705	1"	1"	2"	4-1/2"	6
ABM-CT-13706	1-1/16"	3/4"	2"	4-1/4"	6
ABM-CT-13707	1-1/8"	3/4"	2"	4-1/4"	6
ABM-CT-13708	1-3/16"	3/4"	2"	4-1/4"	6
ABM-CT-13709	1-1/4"	3/4"	2"	4-1/4"	6
ABM-CT-13760	1-1/4"	1"	2"	4-1/2"	6
ABM-CT-13761	1-1/4"	1-1/4"	2"	4-1/2"	6
ABM-CT-13762	1-5/16"	3/4"	2"	3-7/2"	6
ABM-CT-13763	1-3/8"	3/4"	2"	4-1/2"	6
ABM-CT-13764	1-3/8"	1"	2"	4-1/2"	6
ABM-CT-13765	1-7/16"	3/4"	2"	4-1/2"	6
ABM-CT-13766	1-1/2"	3/4"	2"	4-1/2"	6
ABM-CT-13767	1-1/2"	1"	2"	4-1/2"	6
ABM-CT-13768	1-1/2"	1-1/4"	2"	4-1/2"	6
ABM-CT-13769	1-5/8"	3/4"	2"	4-1/2"	6
ABM-CT-13770	1-5/8"	1-1/4"	2"	4-1/2"	6
ABM-CT-13771	1-3/4"	3/4"	2"	4-1/2"	6
ABM-CT-13772	1-3/4"	1-1/4"	2"	4-1/2"	6
ABM-CT-13773	1-7/8"	1-1/4"	2"	4-1/2"	6
ABM-CT-13774	2"	3/4"	2"	4-1/2"	8

While placing order please mention Material M2, M35 and M42.
Also mention with or without Centre Cutting

End Mill Cutters (Double End)

- End Mill Cutters (Single End) are available in HSS M2, HSS M35 (5% Cobalt) and HSS M42 (8% Cobalt)
- With Centre Cutting and without Centre Cutting.
- Also available in MM series.

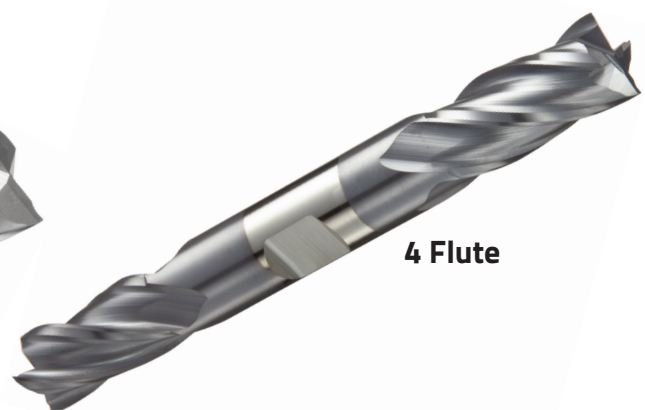

End Mill Cutter - 2 Flutes				
2 Flutes Item Code No.	Size	Shank Dia.	Flute length	Overall Length
ABM-CT-13790	1/8"	3/8"	3/8"	3-1/16"
ABM-CT-13791	5/32"	3/8"	7/16"	3-1/8"
ABM-CT-13792	3/16"	3/8"	7/16"	3-1/8"
ABM-CT-13793	7/32"	3/8"	1/2"	3-1/8"
ABM-CT-13794	1/4"	3/8"	1/2"	3-1/8"
ABM-CT-13795	9/32"	3/8"	9/16"	3-1/8"
ABM-CT-13796	5/16"	3/8"	9/16"	3-1/8"
ABM-CT-13797	11/32"	3/8"	9/16"	3-1/8"
ABM-CT-13798	3/8"	3/8"	9/16"	3-1/8"
ABM-CT-13799	13/32"	1/2"	13/16"	3-3/4"
ABM-CT-13800	7/16"	1/2"	13/16"	3-3/4"
ABM-CT-13801	15/32"	1/2"	13/16"	3-3/4"
ABM-CT-13802	1/2"	1/2"	13/16"	3-3/4"
ABM-CT-13803	9/16"	5/8"	1-1/8"	4-1/2"
ABM-CT-13804	5/8"	5/8"	1-1/8"	4-1/2"
ABM-CT-13805	11/16"	3/4"	1-5/16"	5"
ABM-CT-13806	3/4"	3/4"	1-5/16"	5"
ABM-CT-13807	13/16"	7/8"	1-9/16"	5-1/2"
ABM-CT-13808	7/8"	7/8"	1-9/16"	5-1/2"
ABM-CT-13809	15/16"	1"	1-5/8"	5-7/8"
ABM-CT-13810	1"	1"	1-5/8"	5-7/8"

While placing order please mention Material M2, M35 and M42.
Also mention with or without Centre Cutting

End Mill Cutter - 4 Flutes				
4 Flutes Item Code No.	Size	Shank Dia.	Flute length	Overall Length
ABM-CT-13830	1/8"	3/8"	3/8"	3-1/16"
ABM-CT-13831	5/32"	3/8"	7/16"	3-1/8"
ABM-CT-13832	3/16"	3/8"	1/2"	3-1/4"
ABM-CT-13833	7/32"	3/8"	9/16"	3-1/4"
ABM-CT-13834	1/4"	3/8"	5/8"	3-3/8"
ABM-CT-13835	9/32"	3/8"	11/16"	3-3/8"
ABM-CT-13836	5/16"	3/8"	3/4"	3-1/2"
ABM-CT-13837	11/32"	3/8"	3/4"	3-1/2"
ABM-CT-13838	3/8"	3/8"	3/4"	3-1/2"
ABM-CT-13839	13/32"	1/2"	1"	4-1/8"
ABM-CT-13840	7/16"	1/2"	1"	4-1/8"
ABM-CT-13841	15/32"	1/2"	1"	4-1/8"
ABM-CT-13842	1/2"	1/2"	1"	4-1/8"
ABM-CT-13843	9/16"	5/8"	1-3/8"	5"
ABM-CT-13844	5/8"	5/8"	1-3/8"	5"
ABM-CT-13845	11/16"	3/4"	1-5/8"	5-5/8"
ABM-CT-13846	3/4"	3/4"	1-5/8"	5-5/8"
ABM-CT-13847	13/16"	7/8"	1-7/8"	6-1/8"
ABM-CT-13848	7/8"	7/8"	1-7/8"	6-1/8"
ABM-CT-13849	15/16"	1"	1-7/8"	6-3/8"
ABM-CT-13850	1"	1"	1-7/8"	6-3/8"

While placing order please mention Material M2, M35 and M42.
Also mention with or without Centre Cutting

Miniature Double End Mills

3/16" Shank

- (a) STUB LENGTH L=2" (As per ANSI B94.19)
- (b) REGULAR LENGTH L=2-1/4" (As per ANSI B94.19)
- (c) LONG LENGTH (As per ANSI B94.19)



Stub length L=2" (As per ANSI B94.19)			
2 Flutes Item Code No.	4 Flutes Item Code No.	Size	Length of Cut
ABM-CT-14090	ABM-CT-14100	3/32"	9/64"
ABM-CT-14091	ABM-CT-14101	7/64"	5/32"
ABM-CT-14092	ABM-CT-14102	1/8"	3/16"
ABM-CT-14093	ABM-CT-14103	9/64"	7/32"
ABM-CT-14094	ABM-CT-14104	5/32"	15/64"
ABM-CT-14095	ABM-CT-14105	11/64"	1/4"
ABM-CT-14096	ABM-CT-14106	3/16"	9/32"

Regular length L=2-1/4" (As per ANSI B94.19)			
2 Flutes Item Code No.	4 Flutes Item Code No.	Size	Length of Cut
ABM-CT-14120	ABM-CT-14130	3/32"	9/32"
ABM-CT-14121	ABM-CT-14131	7/64"	21/64"
ABM-CT-14122	ABM-CT-14132	1/8"	3/8"
ABM-CT-14123	ABM-CT-14133	9/64"	13/32"
ABM-CT-14124	ABM-CT-14134	5/32"	7/16"
ABM-CT-14125	ABM-CT-14135	11/64"	1/2"
ABM-CT-14126	ABM-CT-14136	3/16"	1/2"

Long length (As per ANSI B94.19)					
2 Flutes Item Code No.	4 Flutes Item Code No.	Size	Length Below Shank	Length of Cut	Overall Length
ABM-CT-14150	ABM-CT-14160	3/32"	1/2"	9/32"	2-5/8"
ABM-CT-14151	ABM-CT-14161	7/64"	1/2"	9/32"	2-5/8"
ABM-CT-14152	ABM-CT-14162	1/8"	3/4"	3/4"	3-1/8"
ABM-CT-14153	ABM-CT-14163	9/64"	3/4"	3/4"	3-1/8"
ABM-CT-14154	ABM-CT-14164	5/32"	7/8"	7/8"	3-1/4"
ABM-CT-14155	ABM-CT-14165	11/64"	7/8"	7/8"	3-1/4"
ABM-CT-14156	ABM-CT-14166	3/16"	1"	1"	3-3/8"

End Mill Cutters Taper Shank

- End Mill cutters cut material on both the periphery and end simultaneously creating stress since the tool is held only at the spindle.
- Milling bit are used in Milling applications such as profile milling, tracer milling, face milling ,plunging.

Specifications confirm to : IS 6354-1971

- HIGH SPEED STEEL show exceptional results on mild steel, alloy steels and tool steel and are superior finishing tools useful in production processes.



Standard Sizes (Dimension in mm)				
Standard Size Item Code No.	Dia. mm	Cutting Edge Length	Overall Length	Shank Dia.
ABM-CT-14530	6	16	90	1
ABM-CT-14531	7	16	90	1
ABM-CT-14532	8	19	93	1
ABM-CT-14533	9	19	93	1
ABM-CT-14534	10	22	96	1
ABM-CT-14535	11	22	96	1
ABM-CT-14536	12	26	100	1
ABM-CT-14537	13	26	100	1
ABM-CT-14538	14	26	100	1
ABM-CT-14539	15	32	124	2
ABM-CT-14540	16	32	124	2
ABM-CT-14541	17	32	124	2
ABM-CT-14542	18	32	124	2
ABM-CT-14543	19	38	130	2
ABM-CT-14544	20	38	130	2
ABM-CT-14545	21	38	130	2
ABM-CT-14546	22	38	130	2
ABM-CT-14547	23	45	157	3

Long Series (Dimension in mm)				
Long Series Item Code No.	Dia. mm	Cutting Edge Length	Overall Length	Shank Dia.
ABM-CT-14610	6	30	104	1
ABM-CT-14611	7	30	104	1
ABM-CT-14612	8	38	112	1
ABM-CT-14613	9	38	112	1
ABM-CT-14614	10	45	119	1
ABM-CT-14615	11	45	119	1
ABM-CT-14616	12	53	127	1
ABM-CT-14617	13	53	127	1
ABM-CT-14618	14	53	127	1
ABM-CT-14619	15	63	155	2
ABM-CT-14620	16	63	155	2
ABM-CT-14621	17	63	155	2
ABM-CT-14622	18	63	155	2
ABM-CT-14623	19	75	167	2
ABM-CT-14624	20	75	167	2
ABM-CT-14625	21	75	167	2
ABM-CT-14626	22	75	167	2
ABM-CT-14627	23	90	202	3



Cutting Tools

Standard Sizes (Dimension in mm)				
Standard Size Item Code No.	Dia. mm	Cutting Edge Length	Overall Length	Shank Dia.
ABM-CT-14548	24	45	157	3
ABM-CT-14549	25	45	157	3
ABM-CT-14550	26	45	157	3
ABM-CT-14551	27	45	157	3
ABM-CT-14552	28	45	157	3
ABM-CT-14553	29	53	165	3
ABM-CT-14554	30	53	165	3
ABM-CT-14555	31	53	165	3
ABM-CT-14556	32	53	165	3
ABM-CT-14557	33	53	193	4
ABM-CT-14558	34	53	193	4
ABM-CT-14559	35	53	193	4
ABM-CT-14560	36	63	203	4
ABM-CT-14561	37	63	203	4
ABM-CT-14562	38	63	203	4
ABM-CT-14563	39	63	203	4
ABM-CT-14564	40	63	203	4
ABM-CT-14565	42	63	203	4
ABM-CT-14566	43	63	203	4
ABM-CT-14567	44	63	203	4
ABM-CT-14568	45	63	250	4
ABM-CT-14569	46	75	250	5
ABM-CT-14570	48	75	250	5
ABM-CT-14571	49	75	250	5
ABM-CT-14572	50	75	250	5
ABM-CT-14573	52	75	250	5
ABM-CT-14574	54	75	250	5
ABM-CT-14575	55	75	250	5
ABM-CT-14576	56	75	250	5
ABM-CT-14577	58	90	265	5
ABM-CT-14578	59	90	265	5
ABM-CT-14579	60	90	265	5
ABM-CT-14580	62	90	265	5
ABM-CT-14581	63	90	265	5

Long Series (Dimension in mm)				
Long Series Item Code No.	Dia. mm	Cutting Edge Length	Overall Length	Shank Dia.
ABM-CT-14628	24	90	202	3
ABM-CT-14629	25	90	202	3
ABM-CT-14630	26	90	202	3
ABM-CT-14631	27	90	202	3
ABM-CT-14632	28	90	202	3
ABM-CT-14633	29	106	218	3
ABM-CT-14634	30	106	218	3
ABM-CT-14635	31	106	218	3
ABM-CT-14636	32	106	218	3
ABM-CT-14637	33	106	246	4
ABM-CT-14638	34	125	246	4
ABM-CT-14639	35	125	246	4
ABM-CT-14640	36	125	265	4
ABM-CT-14641	37	125	265	4
ABM-CT-14642	38	125	265	4
ABM-CT-14643	39	125	265	4
ABM-CT-14644	40	125	265	4
ABM-CT-14645	42	125	265	4
ABM-CT-14646	43	125	265	4
ABM-CT-14647	44	125	265	4
ABM-CT-14648	45	125	265	4
ABM-CT-14649	46	150	325	5
ABM-CT-14650	48	150	325	5
ABM-CT-14651	49	150	325	5
ABM-CT-14652	50	150	325	5
ABM-CT-14653	52	150	325	5
ABM-CT-14654	54	150	325	5
ABM-CT-14655	55	150	325	5
ABM-CT-14656	56	150	325	5
ABM-CT-14657	58	180	355	5
ABM-CT-14658	59	180	355	5
ABM-CT-14659	60	180	355	5
ABM-CT-14660	62	180	355	5
ABM-CT-14661	63	180	355	5

Parallel Shank End Mill Cutters

- End Mill cutters cut material on both the periphery and end simultaneously creating stress since the tool is held only at the spindle.
- Milling bit are used in Milling applications such as profile milling, tracer milling, face milling, plunging.

Specifications confirm to : IS 6353-1991 ISO 1641: Part 1:1978

- HIGH SPEED STEEL show exceptional results on mild steel, alloy steels and tool steel and are superior finishing tools useful in production processes.



Cutting Tools



Standard Sizes (Dimension in mm)				
Standard Size Item Code No.	Dia. mm	Cutting Edge Length	Overall Length	Shank Dia.
ABM-CT-14300	6	16	52	6
ABM-CT-14301	7	16	52	6
ABM-CT-14302	8	19	59	8
ABM-CT-14303	9	19	59	8
ABM-CT-14304	10	22	67	10
ABM-CT-14305	11	22	67	10
ABM-CT-14306	12	26	76	12
ABM-CT-14307	13	26	76	12
ABM-CT-14308	14	26	76	12
ABM-CT-14309	15	32	88	16
ABM-CT-14310	16	32	88	16
ABM-CT-14311	17	32	88	16
ABM-CT-14312	18	32	88	16
ABM-CT-14313	19	38	101	20
ABM-CT-14314	20	38	101	20
ABM-CT-14315	21	38	101	20
ABM-CT-14316	22	38	101	20
ABM-CT-14317	23	38	101	20
ABM-CT-14318	24	45	116	25
ABM-CT-14319	25	45	116	25
ABM-CT-14320	26	45	116	25
ABM-CT-14321	27	45	116	25
ABM-CT-14322	28	45	116	25
ABM-CT-14323	29	45	116	25
ABM-CT-14324	30	45	116	25
ABM-CT-14325	31	63	140	25
ABM-CT-14326	32	63	140	25
ABM-CT-14327	33	63	140	25
ABM-CT-14328	34	70	160	32
ABM-CT-14329	35	70	160	32
ABM-CT-14330	36	70	160	32
ABM-CT-14331	37	70	160	32
ABM-CT-14332	38	70	160	32
ABM-CT-14333	39	70	160	32
ABM-CT-14334	40	70	160	32
ABM-CT-14335	41	70	160	32
ABM-CT-14336	42	90	180	40
ABM-CT-14337	43	90	180	40
ABM-CT-14338	44	90	180	40
ABM-CT-14339	45	90	180	40
ABM-CT-14340	46	90	200	40
ABM-CT-14341	47	90	200	40
ABM-CT-14342	48	90	200	40

Long Series (Dimension in mm)				
Long Series Item Code No.	Dia. mm	Cutting Edge Length	Overall Length	Shank Dia.
ABM-CT-14370	6	24	68	6
ABM-CT-14371	7	30	74	8
ABM-CT-14372	8	38	82	8
ABM-CT-14373	9	38	88	10
ABM-CT-14374	10	45	95	10
ABM-CT-14375	11	45	102	12
ABM-CT-14376	12	53	110	12
ABM-CT-14377	13	53	110	12
ABM-CT-14378	14	53	110	12
ABM-CT-14379	15	63	123	16
ABM-CT-14380	16	63	123	16
ABM-CT-14381	17	63	123	16
ABM-CT-14382	18	63	123	16
ABM-CT-14383	19	75	141	20
ABM-CT-14384	20	75	141	20
ABM-CT-14385	21	75	141	20
ABM-CT-14386	22	75	141	20
ABM-CT-14387	23	90	166	20
ABM-CT-14388	24	90	166	20
ABM-CT-14389	25	90	166	25
ABM-CT-14390	26	90	166	25
ABM-CT-14391	27	90	166	25
ABM-CT-14392	28	90	166	25
ABM-CT-14393	29	106	186	25
ABM-CT-14394	30	106	186	25
ABM-CT-14395	31	106	186	25
ABM-CT-14396	32	106	186	32
ABM-CT-14397	33	106	186	32
ABM-CT-14398	34	106	186	32
ABM-CT-14399	35	106	186	32
ABM-CT-14400	36	106	186	32
ABM-CT-14401	37	125	217	32
ABM-CT-14402	38	125	217	32
ABM-CT-14403	39	125	217	32
ABM-CT-14404	40	125	217	32
ABM-CT-14405	42	125	217	40
ABM-CT-14406	43	125	217	40
ABM-CT-14407	44	125	217	40
ABM-CT-14408	45	125	217	40
ABM-CT-14409	46	150	252	40
ABM-CT-14410	48	150	252	40
ABM-CT-14411	49	150	252	40
ABM-CT-14412	50	150	252	50

Cutting Tools

Cutting Tools

Cutting Tools

Cutting Tools

Cutting Tools

Cutting Tools



Cutting Tools

Standard Sizes (Dimension in mm)				
Standard Size Item Code No.	Dia. mm	Cutting Edge Length	Overall Length	Shank Dia.
ABM-CT-14343	49	90	200	40
ABM-CT-14344	50	90	200	40
ABM-CT-14345	52	90	200	40
ABM-CT-14346	54	90	200	40
ABM-CT-14347	55	90	200	40
ABM-CT-14348	56	90	200	40
ABM-CT-14349	58	90	200	40
ABM-CT-14350	59	90	200	40
ABM-CT-14351	60	90	200	40
ABM-CT-14352	62	90	200	40
ABM-CT-14353	63	90	200	40

Extra Long Series (Dimension in mm)				
Extra Long Series Item Code No.	Dia. mm	Cutting Edge Length	Overall Length	Shank Dia.
ABM-CT-14450	12	75	125	12
ABM-CT-14451	12	100	150	12
ABM-CT-14452	12	150	200	12
ABM-CT-14453	12	200	250	12
ABM-CT-14454	14	75	125	12
ABM-CT-14455	14	100	150	12
ABM-CT-14456	14	150	200	12
ABM-CT-14457	14	200	250	12
ABM-CT-14458	15	75	125	12
ABM-CT-14459	15	100	150	12
ABM-CT-14460	15	150	200	12
ABM-CT-14461	15	200	250	12
ABM-CT-14462	16	75	125	16
ABM-CT-14463	16	100	150	16
ABM-CT-14464	16	150	200	16
ABM-CT-14465	16	200	250	16
ABM-CT-14466	18	100	150	16
ABM-CT-14467	18	150	200	16
ABM-CT-14468	18	200	250	16
ABM-CT-14469	20	100	150	20
ABM-CT-14470	20	150	200	20
ABM-CT-14471	20	200	250	20
ABM-CT-14472	22	100	150	20
ABM-CT-14473	22	150	200	20
ABM-CT-14474	22	200	250	20
ABM-CT-14475	25	150	200	25
ABM-CT-14476	25	200	250	25
ABM-CT-14477	25	250	300	25

Long Series (Dimension in mm)				
Long Series Item Code No.	Dia. mm	Cutting Edge Length	Overall Length	Shank Dia.
ABM-CT-14413	52	150	252	50
ABM-CT-14414	54	150	252	50
ABM-CT-14415	55	150	252	50
ABM-CT-14416	56	150	252	50
ABM-CT-14417	58	180	282	50
ABM-CT-14418	59	180	282	50
ABM-CT-14419	60	180	282	50
ABM-CT-14420	62	180	282	50
ABM-CT-14421	63	180	282	50
ABM-CT-14422	65	180	292	50
ABM-CT-14423	66	180	292	50
ABM-CT-14424	68	180	292	50
ABM-CT-14425	69	180	292	50
ABM-CT-14426	70	180	292	50
ABM-CT-14427	71	180	292	63

Extra Long Series (Dimension in mm)				
Extra Long Series Item Code No.	Dia. mm	Cutting Edge Length	Overall Length	Shank Dia.
ABM-CT-14478	26	150	200	25
ABM-CT-14479	26	200	250	25
ABM-CT-14480	28	150	200	25
ABM-CT-14481	28	200	250	25
ABM-CT-14482	30	150	200	25
ABM-CT-14483	30	200	250	25
ABM-CT-14484	32	125	200	32
ABM-CT-14485	32	150	225	32
ABM-CT-14486	34	150	200	32
ABM-CT-14487	34	200	250	32
ABM-CT-14488	35	150	200	32
ABM-CT-14489	35	200	250	32
ABM-CT-14490	36	150	200	32
ABM-CT-14491	36	200	250	32
ABM-CT-14492	38	150	200	32
ABM-CT-14493	38	200	250	40
ABM-CT-14494	40	150	200	40
ABM-CT-14495	40	200	250	40
ABM-CT-14496	42	150	200	40
ABM-CT-14497	42	200	250	40
ABM-CT-14498	45	150	200	40
ABM-CT-14499	45	200	250	40
ABM-CT-14500	48	150	200	40
ABM-CT-14501	48	200	250	40
ABM-CT-14502	50	150	200	50
ABM-CT-14503	50	200	250	50

Slot Milling Cutters Parallel Shank

Parallel Shank HSS Slot Drill Keyway Milling Cutter

- Specification confirm to IS 6352-1971 Dimensions in mm.
- Specification confirm to BS 122 / PART 1 – 1953 Dimensions in INCHES.
- Mainly used for machining round headed flat key seats.
- Also used to work open grooves, some are used for insertion milling, drilling.
- Suitable for milling grooves with width requirements.
- Spiral-teethed structure ensures smooth cutting.
- Having an excellent self-centering capability, can processing H7 workpiece efficiently.
- Processed holes can achieve high position and have a good straightness and surface finish.
- For materials with short chips such as cast iron, silicon-aluminum alloy, etc
- Designed for a general performance to carbon steel ,tool steel, alloy steel and stainless steel.
- Roughing end mills allow for heavier cuts and remove more material.



Specification confirm to IS 6352-1971 Dimensions in mm.				
mm Item Code No.	Cutting Edge Dia.	Cutting Edge Length	Overall Length	Shank Dia.
ABM-CT-14690	3	6	40	6
ABM-CT-14691	4	6	40	6
ABM-CT-14692	5	8	45	8
ABM-CT-14693	6	8	45	8
ABM-CT-14694	7	10	50	10
ABM-CT-14695	8	10	50	10
ABM-CT-14696	9	10	50	10
ABM-CT-14697	10	12	56	12
ABM-CT-14698	11	12	56	12
ABM-CT-14699	12	16	63	16
ABM-CT-14700	14	16	63	16
ABM-CT-14701	15	16	63	16
ABM-CT-14702	16	18	70	18
ABM-CT-14703	18	18	70	18
ABM-CT-14704	20	20	80	20
ABM-CT-14705	21	20	80	20
ABM-CT-14706	22	22	90	22
ABM-CT-14707	23	22	90	22
ABM-CT-14708	24	25	100	25
ABM-CT-14709	25	25	100	25
ABM-CT-14710	26	25	100	25
ABM-CT-14711	28	25	100	25

Slot Milling Cutters for right hand Cutting with Right Hand Helical Flutes and Flat Face (Type A) and Tool Type N Shall be supplied unless otherwise specified

Specification confirm to BS 122 / PART 1 – 1953 Dimensions in INCHES				
Inches Item Code No.	Cutting Edge Dia.	Cutting Edge Length	Overall Length	Shank Dia.
ABM-CT-14730	1/8	3/8	1-7/8	1/4
ABM-CT-14731	5/32	3/8	1-7/8	1/4
ABM-CT-14732	3/16	1/2	2	1/4
ABM-CT-14733	7/32	1/2	2	1/4
ABM-CT-14734	1/4	5/8	2-1/8	1/4
ABM-CT-14735	5/16	3/4	2-1/2	3/8
ABM-CT-14736	3/8	7/8	2-5/8	3/8
ABM-CT-14737	7/16	7/8	2-5/8	1/2
ABM-CT-14738	1/2	1	2-3/4	1/2
ABM-CT-14739	9/16	1-1/8	2-7/8	1/2
ABM-CT-14740	5/8	1-1/4	3-1/4	5/8
ABM-CT-14741	11/16	1-3/8	3-3/8	5/8
ABM-CT-14742	3/4	1-1/2	3-1/2	5/8
ABM-CT-14743	7/8	1-5/8	3-5/8	3/4
ABM-CT-14744	1	1-3/4	3-3/4	3/4

Slot Milling Cutters for right hand Cutting with Right Hand Helical Flutes Shall be supplied unless otherwise specified

Involute Gear Cutter Set HSS B.S. 2518-1954

- A Cutter with Radially Machine relieved teeth on periphery to cut a single tooth pace in Gear.

Diametrical Pitch Cutters Pressure Angle 14-1/2°

Dimension in Inches

Item Code No.	Bore 1" or 27 mm D.P.	Dia.
ABM-CT-13950	50 to 26 (Even Only)	2-1/4
ABM-CT-13951	25	2-1/4
ABM-CT-13952	24	2-1/4
ABM-CT-13953	23	2-1/4
ABM-CT-13954	22	2-1/4
ABM-CT-13955	21	2-1/4
ABM-CT-13956	20	2-3/8
ABM-CT-13957	19	2-3/8
ABM-CT-13958	18	2-3/8



Module Cutters pressure Angle 20°

Dimension in mm

Item Code No.	Module	Dia.
ABM-CT-13970	1.0	57
ABM-CT-13971	1.25	61
ABM-CT-13972	1.5	64
ABM-CT-13973	1.75	64
ABM-CT-13974	2 or 2.25	67
ABM-CT-13975	2.5	70

All Cutters are 0.5 Module

SETS

Item Code No.	Forms	Cut Gears from	OD	Bore
ABM-CT-13990	Form # 2	14 - 16 Theeth's	40 mm	16 mm
ABM-CT-13991	Form # 3	17 - 20 Theeth's	40 mm	16 mm
ABM-CT-13992	Form # 4	21 - 25 Theeth's	40 mm	16 mm
ABM-CT-13993	Form # 5	26 - 34 Theeth's	40 mm	16 mm
ABM-CT-13994	Form # 6	35 - 54 Theeth's	40 mm	16 mm
ABM-CT-13995	Set of Above Forms			

Adjustable Hand Reamer

- An adjustable hand reamer is a tool used to smooth the bore walls of a drilled hole when precise sizing is necessary.
- The blades of an adjustable reamer are separate from the body and are fitted into ramped grooves in the body.
- As the blade slides along the groove the cutting diameter is changed.
- While, Captive nuts located at each end of the blades lock them in a fixed position.
- The cutting diameter can be adjusted by loosening one nut while tightening the other.
- One reamer does the work of many.
- Each reamer can expands from smallest size to next large size by loosening one adjusting nut and tightening the other.
- Available in Inches and mm Sizes.
- Available in Blades made of Carbon Steel and High Speed Steel (HSS) Material.
- SETS Packed in attractive Wooden Box Packing.
- The most economical tool for precisely reaming a small number of odd-sized holes.
- Adjustable to precisely fit a range of sizes, eliminating the need for single purpose, special diameter reamers.
- Worn blades can be easily replaced by the user.



Item Code No.	American Size	Industrial Code	Range		No of Blades
			Inches	mm	
ABM-CT-13180	8/A	HV	1/4" to 9/32"	6.35 to 7.14	4
ABM-CT-13181	7/A	HW	9/32" to 5/16"	7.14 to 7.94	4
ABM-CT-13182	6/A	HZ	5/16" to 11/32"	7.94 to 8.73	4
ABM-CT-13183	5/A	HY	11/32" to 3/8"	8.73 to 9.52	5
ABM-CT-13184	4/A	H-1	3/8" to 13/32"	9.52 to 10.32	6
ABM-CT-13185	3/A	H-2	13/32" to 7/16"	10.32 to 11.11	6
ABM-CT-13186	2/A	H-3	7/16" to 15/32"	11.11 to 11.91	6
ABM-CT-13187	A	H-4	15/32" to 17/32"	11.91 to 13.49	6
ABM-CT-13188	B	H-5	17/32" to 19/32"	13.49 to 15.08	6
ABM-CT-13189	C	H-6	19/32" to 21/32"	15.08 to 16.67	6
ABM-CT-13190	D	H-7	21/32" to 23/32"	16.67 to 18.26	6
ABM-CT-13191	E	H-8	23/32" to 25/32"	18.26 to 19.84	6
ABM-CT-13192	F	H-9	25/32" to 27/32"	19.84 to 21.43	6
ABM-CT-13193	G	H-10	27/32" to 15/16"	21.43 to 23.81	6
ABM-CT-13194	H	H-11	15/16" to 1-1/16"	23.81 to 26.99	6
ABM-CT-13195	I	H-12	1-1/16" to 1-3/16"	26.99 to 30.16	6
ABM-CT-13196	J	H-13	1-3/16" to 1-11/32"	30.16 to 34.13	6
ABM-CT-13197	K	H-14	1-11/32" to 1-1/2"	34.13 to 38.10	6
ABM-CT-13198	L	H-15	1-1/2" to 1-13/16"	38.10 to 46.04	6
ABM-CT-13199	M	H-16	1-13/16" to 2-7/32"	46.04 to 56.36	6
ABM-CT-13200	N	H-17	2-7/32" to 2-3/4"	56.36 to 69.85	6
ABM-CT-13201	O	H-18	2-3/4" to 3-11/32"	69.85 to 84.93	6
ABM-CT-13202	P	H-19	3-11/32 to 4	84.93 to 100	6
ABM-CT-13203	Q	H-20	4 to 4-3/4	100 to 120	6
ABM-CT-13204	R	H-21	4-3/4 to 5-1/2	120 to 140	6
ABM-CT-13208	Set of 7 Reamers - Size 8/A to 2/A (HV to H-3)				
ABM-CT-13209	Set of 8 Reamers - Size A to H (H-4 to H-11)				
ABM-CT-13210	Set of 11 Reamers - A to K (H-4 to H-14)				
ABM-CT-13211	Set of 9 Reamers - A to I (H-4 to H-12)				
ABM-CT-13212	Set of 5 Reamers - I to M (H-12 to H-16)				

* While placing order please mention Carbon Steel or HSS Blades.
 * Sets can be made as per customer requirements.

Repairman's Taper Reamer

- Repairman's Reamers (multi-fluted, end cutting tools) used to enlarge and countersink previously formed holes.
- These Carbon Steel Sliding T-Handle models are useful for removing burrs in soft metals, plastic tubing and similar materials up to 1/2" diameter.
- Repairman's reamer features 7 flutes for smooth bores, removable handle for compact storage and reams holes.
- Handy tool for Mechanics, Electricians, Plumbers, Machinist and Carpenters.
- Removes burrs from small holes.
- Enlarge and countersinks holes in soft metals.

Item Code No.	Range
ABM-CT-13630	1/8" to 1/2"
ABM-CT-13631	1/8" to 5/8"
ABM-CT-13632	3/16" to 7/8"



Machine Reamers - HSS Taper Shank

- These high-quality reamers have been designed for opening out and finishing holes in most ferrous and non-ferrous materials.
- Material : M2, M35, M42, ASP 2030 & ASP 2052
- Size : 2mm to 60mm
- Application / Usage : Suitable for cast iron, Steel, stainless steel reaming and non-ferrous materials.
- Tolerance: DIN 1420
- Left or Right Hand
- Can be supplied with all types of Coatings.
- Requires less setup than chucking reamers
- Type : Straight or Spiral Flute
- Customization of Tools is also available as per customer requirement.
- A Reamer having virtually parallel cutting edges, with bevel lead integral with a Morse Taper Shank.



Specification conform to IS 5444-1978 / IS 5445 -1978/ ISO 236/1-1976 DIN 206-1979
Dimensions in mm.

Standard Size Item Code No.	Dia.	Cutting Edge Length	Overall Length	Morse Taper No.
ABM-CT-15070	3	31	111	1
ABM-CT-15071	4	38	118	1
ABM-CT-15072	5	44	124	1
ABM-CT-15073	6	47	127	1
ABM-CT-15074	7	54	134	1
ABM-CT-15075	8	58	138	1
ABM-CT-15076	9	62	142	1
ABM-CT-15077	10	66	146	1
ABM-CT-15078	11	71	151	1
ABM-CT-15079	12	76	156	1
ABM-CT-15080	13	76	156	1
ABM-CT-15081	14	81	161	1
ABM-CT-15082	15	81	181	2
ABM-CT-15083	16	87	187	2
ABM-CT-15084	17	87	187	2
ABM-CT-15085	18	93	193	2
ABM-CT-15086	19	93	193	2
ABM-CT-15087	20	100	200	2
ABM-CT-15088	21	100	200	2
ABM-CT-15089	22	107	207	2
ABM-CT-15090	23	107	207	2
ABM-CT-15091	24	115	242	3
ABM-CT-15092	25	115	242	3
ABM-CT-15093	26	115	242	3
ABM-CT-15094	27	124	251	3
ABM-CT-15095	28	124	251	3

Specification conform to IS 5444-1978 / IS 5445 -1978/ ISO 236/1-1976 DIN 206-1979
Dimensions in mm.

Standard Size Item Code No.	Dia.	Cutting Edge Length	Overall Length	Morse Taper No.
ABM-CT-15096	30	124	251	3
ABM-CT-15097	32	133	293	4
ABM-CT-15098	34	142	302	4
ABM-CT-15099	35	142	302	4
ABM-CT-15100	36	142	302	4
ABM-CT-15101	38	152	312	4
ABM-CT-15102	40	152	312	4
ABM-CT-15103	42	152	312	4
ABM-CT-15104	44	163	323	4
ABM-CT-15105	45	163	323	4
ABM-CT-15106	46	163	323	4
ABM-CT-15107	48	174	334	4
ABM-CT-15108	50	174	334	4
ABM-CT-15109	52	174	371	5
ABM-CT-15110	55	184	381	5
ABM-CT-15111	56	184	381	5
ABM-CT-15112	58	184	381	5
ABM-CT-15113	60	184	381	5
ABM-CT-15114	62	194	391	5
ABM-CT-15115	63	194	391	5
ABM-CT-15116	67	194	393	5
ABM-CT-15117	71	203	400	5

* LH Helical flutes for RH cutting will be provided unless otherwise specified.

Specification confirm to BS 122 / BS 328: Part 4:1983 / DIN9
Dimensions in INCHES

Standard Size Item Code No.	Dia.	Cutting Edge Length	Overall Length	Morse Taper No.
ABM-CT-15140	1/8	1-5/16	4-7/16	1
ABM-CT-15141	5/32	1-1/2	4-5/8	1
ABM-CT-15142	3/16	1-3/4	4-7/8	1
ABM-CT-15143	1/4	2	5-1/8	1
ABM-CT-15144	9/32	2-1/8	5-1/4	1
ABM-CT-15145	5/16	2-1/4	5-3/8	1
ABM-CT-15146	11/32	2-7/16	5-9/16	1
ABM-CT-15147	3/8	2-5/8	5-3/4	1
ABM-CT-15148	13/32	2-5/8	5-3/4	1
ABM-CT-15149	7/16	2-13/16	5-15/16	1
ABM-CT-15150	15/32	3	6-1/8	1
ABM-CT-15151	1/2	3	6-1/8	1
ABM-CT-15152	9/16	3-3/16	7-1/8	2
ABM-CT-15153	5/8	3-7/16	7-3/8	2
ABM-CT-15154	11/16	3-11/16	7-5/8	2
ABM-CT-15155	3/4	3-15/16	7-7/8	2
ABM-CT-15156	13/16	3-15/16	7-7/8	2

* LH Helical flutes for RH cutting will be provided unless otherwise specified.

Parallel Hand Reamers - HSS

- These high-quality reamers have been designed for opening out and finishing holes in most ferrous and non-ferrous materials.
- Material : M2, M35, M42, ASP 2030 & ASP 2052
- Size : 2mm to 60mm
- Application / Usage : Suitable for cast iron, Steel, stainless steel reaming and non-ferrous materials.
- Tolerance: DIN 1420
- Left or Right Hand
- Can be supplied with all types of Coatings.
- Requires less setup than chucking reamers
- Type : Straight or Spiral Flute
- Customization of Tools is also available as per customer requirement.

Specification confirm to IS 5444-1978 / IS 5445 -1978/
ISO 236/1-1976 DIN 206-1979
Dimensions in mm.

Item Code No.	Dia.	Cutting Edge Length	Overall Length
ABM-CT-14780	3	31	62
ABM-CT-14781	3.5	35	71
ABM-CT-14782	4	38	86
ABM-CT-14783	4.5	41	81
ABM-CT-14784	5	44	87
ABM-CT-14785	5.5	47	93
ABM-CT-14786	6	47	93
ABM-CT-14787	7	54	107

Specification confirm to BS 122 / BS 328: Part 4:1983 / DIN9
Dimensions in INCHES

Standard Size Item Code No.	Dia.	Cutting Edge Length	Overall Length	Morse Taper No.
ABM-CT-15157	7/8	4-3/16	8-1/8	2
ABM-CT-15158	15/16	4-1/2	9-1/2	3
ABM-CT-15159	1	4-1/2	9-1/2	3
ABM-CT-15160	1-1/16	4-7/8	9-7/8	3
ABM-CT-15161	1-1/8	4-4/8	9-7/8	3
ABM-CT-15162	1-3/16	5-1/4	10-1/4	3
ABM-CT-15163	1-1/4	5-1/4	10-1/4	3
ABM-CT-15164	1-5/16	5-1/4	11-9/16	4
ABM-CT-15165	1-3/8	5-5/8	11-15/16	4
ABM-CT-15166	1-7/16	5-5/8	11-15/16	4
ABM-CT-15167	1-1/2	6	12-5/16	4
ABM-CT-15168	1-5/8	6	12-5/16	4
ABM-CT-15169	1-3/4	6-7/16	12-3/4	4
ABM-CT-15170	1-7/8	6-7/8	13-3/16	4
ABM-CT-15171	2	6-7/8	13-3/16	4
ABM-CT-15172	2-1/4	7-1/4	15	5
ABM-CT-15173	2-1/2	7-5/8	15-3/8	5
ABM-CT-15174	3	8-3/8	16-1/8	5



Specification confirm to BS 122 / BS 328: Part 4:1983
Dimensions in INCHES

Item Code No.	Dia.	Cutting Edge Length	Overall Length
ABM-CT-15000	1/8	1-5/16	2-5/8
ABM-CT-15001	5/32	1-1/2	3
ABM-CT-15002	3/16	1-3/4	3-7/16
ABM-CT-15003	7/32	1-7/8	3-11/16
ABM-CT-15004	1/4	2	3-15/16
ABM-CT-15005	9/32	2-1/8	4-3/16

Cutting Tools



Cutting Tools
Cutting Tools
Cutting Tools
Cutting Tools
Cutting Tools

Specification confirm to IS 5444-1978 / IS 5445 -1978/ ISO 236/1-1976 DIN 206-1979 (Dimensions in mm.)

Item Code No.	Dia.	Cutting Edge Length	Overall Length
ABM-CT-14788	8	58	115
ABM-CT-14789	9	62	124
ABM-CT-14790	10	66	133
ABM-CT-14791	11	71	142
ABM-CT-14792	12	76	152
ABM-CT-14793	13	76	152
ABM-CT-14794	14	81	163
ABM-CT-14795	15	81	163
ABM-CT-14796	16	87	175
ABM-CT-14797	17	87	175
ABM-CT-14798	18	93	188
ABM-CT-14799	19	93	188
ABM-CT-14800	20	100	201
ABM-CT-14801	21	100	201
ABM-CT-14802	22	107	215
ABM-CT-14803	23	107	215
ABM-CT-14804	24	115	231
ABM-CT-14805	25	115	231
ABM-CT-14806	26	115	231
ABM-CT-14807	27	124	247
ABM-CT-14808	28	124	247
ABM-CT-14809	30	124	247
ABM-CT-14810	32	133	265
ABM-CT-14811	34	142	284
ABM-CT-14812	35	142	284
ABM-CT-14813	36	142	284
ABM-CT-14814	38	152	305
ABM-CT-14815	40	152	305
ABM-CT-14816	42	152	305
ABM-CT-14817	44	163	326
ABM-CT-14818	45	163	326
ABM-CT-14819	46	163	326
ABM-CT-14820	48	174	347
ABM-CT-14821	50	174	347
ABM-CT-14822	52	174	347
ABM-CT-14823	55	184	347
ABM-CT-14824	56	184	367
ABM-CT-14825	58	184	367
ABM-CT-14826	60	184	367
ABM-CT-14827	62	194	387
ABM-CT-14828	63	194	387
ABM-CT-14829	67	194	387
ABM-CT-14830	71	203	406

Specification confirm to BS 122 / BS 328: Part 4:1983
Dimensions in INCHES

Item Code No.	Dia.	Cutting Edge Length	Overall Length
ABM-CT-15006	5/16	2-1/4	4-1/2
ABM-CT-15007	11/32	2-7/16	4-7/8
ABM-CT-15008	3/8	2-5/8	5-1/4
ABM-CT-15009	13/32	2-5/8	5-1/4
ABM-CT-15010	7/16	2-13/16	5-5/8
ABM-CT-15011	15/32	3	6
ABM-CT-15012	1/2	3	6
ABM-CT-15013	9/16	3-3/16	6-7/16
ABM-CT-15014	5/8	3-7/16	6-7/8
ABM-CT-15015	11/16	3-11/16	7-7/16
ABM-CT-15016	3/4	3-15/16	7-15/16
ABM-CT-15017	13/16	3-15/16	7-15/16
ABM-CT-15018	7/8	4-3/16	8-1/2
ABM-CT-15019	15/16	4-1/2	9-1/16
ABM-CT-15020	1	4-1/2	9-1/16
ABM-CT-15021	1-1/16	4-7/8	9-3/4
ABM-CT-15022	1-1/8	4-7/8	9-3/4
ABM-CT-15023	1-3/16	5-1/4	10-7/16
ABM-CT-15024	1-1/4	5-1/4	10-7/16
ABM-CT-15025	1-5/16	5-1/4	10-7/16
ABM-CT-15026	1-3/8	5-5/8	11-3/16
ABM-CT-15027	1-7/16	5-5/8	11-3/16
ABM-CT-15028	1-1/2	6	12
ABM-CT-15029	1-5/8	6	12
ABM-CT-15030	1-3/4	6-7/16	12-13/16
ABM-CT-15031	1-7/8	6-7/8	13-11/16
ABM-CT-15032	2	6-7/8	13-11/16
ABM-CT-15033	2-1/16	6-7/8	13-11/16
ABM-CT-15034	2-1/8	7-1/4	14-7/16
ABM-CT-15035	2-3/16	7-1/4	14-7/16
ABM-CT-15036	2-1/4	7-1/4	14-7/16
ABM-CT-15037	2-5/16	7-1/4	14-7/16
ABM-CT-15038	2-3/8	7-5/8	15-1/4
ABM-CT-15039	2-7/16	7-5/8	15-1/4
ABM-CT-15040	2-1/2	7-5/8	15-1/4

* LH Helical flutes for RH cutting will be provided unless otherwise specified.

Chucking Reamer

(Straight Shank and Taper Shank) As Per ANSI B94.2

- Design for use in Turret Lathes, Screw Machines, Drill Presses and all type of machine tool equipment.
- Ground with a 45° Chamfer, suitable for reaming most materials.
- Available in Straight Flute and Spiral Flute.
- Use for difficult to ream materials.
- Made from High Speed Steel.

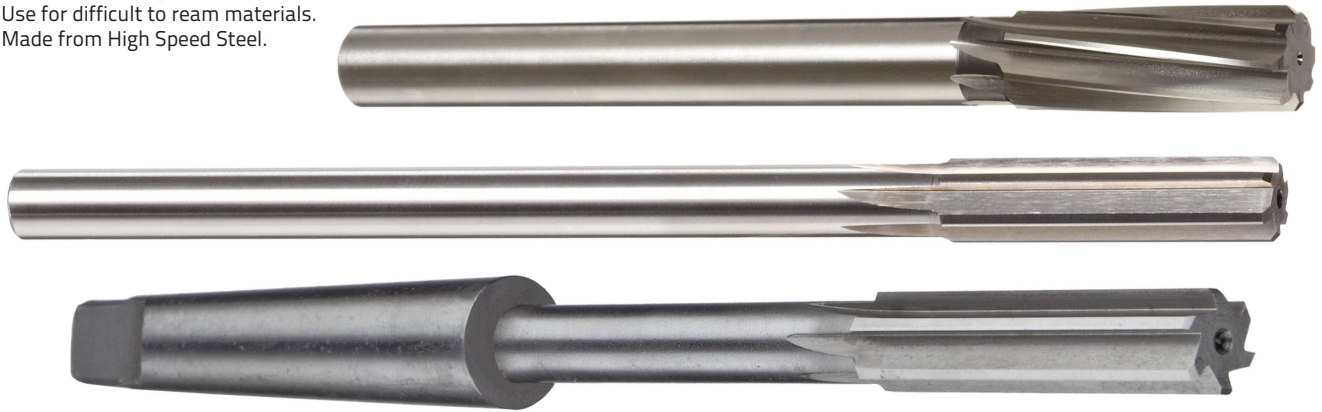

Straight Shank						
Straight Flute Item Code No.	Spiral Flute Item Code No.	Size	Decimal Equipment	Flute Length	Overall Length	No. of Flute
ABM-CT-13240	ABM-CT-13300	1/8"	.1250"	7/8"	3-1/2"	4
ABM-CT-13241	ABM-CT-13301	9/64"	.1406"	1"	4"	4
ABM-CT-13242	ABM-CT-13302	5/32"	.1562"	1"	4"	4
ABM-CT-13243	ABM-CT-13303	11/64"	.1719"	1-1/8"	4-1/2"	6
ABM-CT-13244	ABM-CT-13304	3/16"	.1875"	1-1/8"	4-1/2"	6
ABM-CT-13245	ABM-CT-13305	13/64"	.2031"	1-1/4"	5"	6
ABM-CT-13246	ABM-CT-13306	7/32"	.2188"	1-1/4"	5"	6
ABM-CT-13247	ABM-CT-13307	15/64"	.2344"	1-1/2"	6"	6
ABM-CT-13248	ABM-CT-13308	1/4"	.2500"	1-1/2"	6"	6
ABM-CT-13249	ABM-CT-13309	17/64"	.2656"	1-1/2"	6"	6
ABM-CT-13250	ABM-CT-13310	9/32"	.2812"	1-1/2"	6"	6
ABM-CT-13251	ABM-CT-13311	19/64"	.2969"	1-1/2"	6"	6
ABM-CT-13252	ABM-CT-13312	5/16"	.3125"	1-1/2"	6"	6
ABM-CT-13253	ABM-CT-13313	21/64"	.3281"	1-1/2"	6"	6
ABM-CT-13254	ABM-CT-13314	11/32"	.3438"	1-1/2"	6"	6
ABM-CT-13255	ABM-CT-13315	23/64"	.3594"	1-3/4"	7"	6
ABM-CT-13256	ABM-CT-13316	3/8"	.3750"	1-3/4"	7"	6
ABM-CT-13257	ABM-CT-13317	25/64"	.3906"	1-3/4"	7"	6
ABM-CT-13258	ABM-CT-13318	13/32"	.4062"	1-3/4"	7"	6
ABM-CT-13259	ABM-CT-13319	27/64"	.4219"	1-3/4"	7"	6
ABM-CT-13260	ABM-CT-13320	7/16"	.4375"	1-3/4"	7"	6
ABM-CT-13261	ABM-CT-13321	29/64"	.4531"	1-3/4"	7"	6
ABM-CT-13262	ABM-CT-13322	15/32"	.4688"	1-3/4"	7"	6
ABM-CT-13263	ABM-CT-13323	31/64"	.4844"	2"	8"	6
ABM-CT-13264	ABM-CT-13324	1/2"	.5000"	2"	8"	6
ABM-CT-13265	ABM-CT-13325	17/32"	.5312"	2"	8"	6
ABM-CT-13266	ABM-CT-13326	9/16"	.5625"	2"	8"	6
ABM-CT-13267	ABM-CT-13327	19/32"	.5938"	2"	8"	6



Cutting Tools

Cutting Tools

Cutting Tools

Cutting Tools

Cutting Tools

Straight Shank						
Straight Flute Item Code No.	Spiral Flute Item Code No.	Size	Decimal Equivalent	Flute Length	Overall Length	No. of Flute
ABM-CT-13268	ABM-CT-13328	5/8"	.6250"	2-1/4"	9"	8
ABM-CT-13269	ABM-CT-13329	21/32"	.6562"	2-1/4"	9"	8
ABM-CT-13270	ABM-CT-13330	11/16"	.6875"	2-1/4"	9"	8
ABM-CT-13271	ABM-CT-13331	23/32"	.7188"	2-1/4"	9"	8
ABM-CT-13272	ABM-CT-13332	3/4"	.7500"	2-1/2"	9-1/2"	8
ABM-CT-13273	ABM-CT-13333	25/32"	.7812"	2-1/2"	9-1/2"	8
ABM-CT-13274	ABM-CT-13334	13/16"	.8125"	2-1/2"	9-1/2"	8
ABM-CT-13275	ABM-CT-13335	27/32"	.8438"	2-1/2"	9-1/2"	8
ABM-CT-13276	ABM-CT-13336	7/8"	.8750"	2-5/8"	10"	8
ABM-CT-13277	ABM-CT-13337	29/32"	.9062"	2-5/8"	10"	8
ABM-CT-13278	ABM-CT-13338	15/16"	.9375"	2-5/8"	10"	8
ABM-CT-13279	ABM-CT-13339	31/32"	.9688"	2-5/8"	10"	8
ABM-CT-13280	ABM-CT-13340	1"	1.0000"	2-3/4"	10-1/2"	8
ABM-CT-13281	ABM-CT-13341	1-1/16"	1.0625"	2-3/4"	10-1/2"	10
ABM-CT-13282	ABM-CT-13342	1-1/8"	1.1250"	2-7/8"	11"	10
ABM-CT-13283	ABM-CT-13343	1-3/16"	1.1875"	2-7/8"	11"	10
ABM-CT-13284	ABM-CT-13344	1-1/4"	1.2500"	3"	11-1/2"	10
ABM-CT-13285	ABM-CT-13345	1-5/16"	1.3125"	3-1/4"	12"	10
ABM-CT-13286	ABM-CT-13346	1-3/8"	1.3750"	3-1/4"	12"	12
ABM-CT-13287	ABM-CT-13347	1-7/16"	1.4375"	3-1/2"	12-1/2"	12
ABM-CT-13288	ABM-CT-13348	1-1/2"	1.5000"	3-1/2"	12-1/2"	12

Taper Shank									
Taper Shank Item Code No.	Size	Flute Length	Overall Length	MT Shank	Taper Shank Item Code No.	Size	Flute Length	Overall Length	MT Shank
ABM-CT-13370	1/4"	1-1/2"	6"	1	ABM-CT-13387	25/32"	2-1/2"	9-1/2"	2
ABM-CT-13371	9/32"	1-1/2"	6"	1	ABM-CT-13388	13/16"	2-1/2"	9-1/2"	2
ABM-CT-13372	5/16"	1-1/2"	6"	1	ABM-CT-13389	27/32"	2-1/2"	9-1/2"	2
ABM-CT-13373	11/32"	1-1/2"	6"	1	ABM-CT-13390	7/8"	2-5/8"	10"	2
ABM-CT-13374	3/8"	1-3/4"	7"	1	ABM-CT-13391	29/32"	2-5/8"	10"	2
ABM-CT-13375	13/32"	1-3/4"	7"	1	ABM-CT-13392	15/16"	2-5/8"	10"	3
ABM-CT-13376	7/16"	1-3/4"	7"	1	ABM-CT-13393	31/32"	2-5/8"	10"	3
ABM-CT-13377	15/32"	1-3/4"	7"	1	ABM-CT-13394	1"	2-3/4"	10-1/2"	3
ABM-CT-13378	1/2"	2"	8"	1	ABM-CT-13395	1-1/16"	2-3/4"	10-1/2"	3
ABM-CT-13379	17/32"	2"	8"	1	ABM-CT-13396	1-1/8"	2-7/8"	11"	3
ABM-CT-13380	9/16"	2"	8"	1	ABM-CT-13397	1-3/16"	2-7/8"	11"	3
ABM-CT-13381	19/32"	2"	8"	1	ABM-CT-13398	1-1/4"	3"	11-1/2"	4
ABM-CT-13382	5/8"	2-1/4"	9"	2	ABM-CT-13399	1-5/16"	3"	11-1/2"	4
ABM-CT-13383	21/32"	2-1/4"	9"	2	ABM-CT-13400	1-3/8"	3-1/4"	12"	4
ABM-CT-13384	11/16"	2-1/4"	9"	2	ABM-CT-13401	1-7/16"	3-1/4"	12"	4
ABM-CT-13385	23/32"	2-1/4"	9"	2	ABM-CT-13402	1-1/2"	3-1/2"	12-1/2"	4
ABM-CT-13386	3/4"	2-1/2"	9-1/2"	2					

While placing order please mention Straight Flute or Spiral Flute

Taper Pin Reamers ANSI B94.2

- Available in Straight, Spiral or Helical Flutes.
- Use to Ream holes for Standard Taper Pins.
- Straight and Spiral flutes are intended for hand reaming in easy to ream materials.
- Made of High Speed Steel.
- 1/4" Taper per foot (1 in 48).
- Helical Flute is designed for machine reaming.
- Helical construction helps prevent chips from clogging in flutes, minimizing breakage.



Straight Flute Item Code No.	Spiral Flute Item Code No.	Helical Flute Item Code No.	Size	Shank Dia.	Diameter		Flute length	Overall Length
					Small End	Large End		
ABM-CT-13420	ABM-CT-13450	ABM-CT-13480	7/0	5/64"	.0497"	0.666"	13/16"	1-13/16"
ABM-CT-13421	ABM-CT-13451	ABM-CT-13481	6/0	3/32"	.0611"	.0806"	15/16"	1-15/16"
ABM-CT-13422	ABM-CT-13452	ABM-CT-13482	5/0	7/64"	.0719"	.0966"	1-3/16"	2-3/16"
ABM-CT-13423	ABM-CT-13453	ABM-CT-13483	4/0	1/8"	.0869"	.1142"	1-5/16"	2-5/16"
ABM-CT-13424	ABM-CT-13454	ABM-CT-13484	3/0	9/64"	.1029"	.1302"	1-5/16"	2-5/16"
ABM-CT-13425	ABM-CT-13455	ABM-CT-13485	2/0	5/32"	.1137"	.1462"	1-9/16"	2-9/16"
ABM-CT-13426	ABM-CT-13456	ABM-CT-13486	0	11/64"	.1287"	.1638"	1-11/16"	2-15/16"
ABM-CT-13427	ABM-CT-13457	ABM-CT-13487	1	3/16"	.1447"	.1798"	1-11/16"	2-15/16"
ABM-CT-13428	ABM-CT-13458	ABM-CT-13488	2	13/64"	.1605"	.2008"	1-15/16"	3-3/16"
ABM-CT-13429	ABM-CT-13459	ABM-CT-13489	3	15/64"	.1813"	.2294"	2-5/16"	3-11/16"
ABM-CT-13430	ABM-CT-13460	ABM-CT-13490	4	17/64"	.2071"	.2604"	2-9/16"	4-1/16"
ABM-CT-13431	ABM-CT-13461	ABM-CT-13491	5	5/16"	.2409"	.2994"	2-13/16"	4-5/16"
ABM-CT-13432	ABM-CT-13462	ABM-CT-13492	6	23/64"	.2773"	.3540"	3-11/16"	5-7/16"
ABM-CT-13433	ABM-CT-13463	ABM-CT-13493	7	13/32"	.3297"	.4220"	4-7/16"	6-5/16"
ABM-CT-13434	ABM-CT-13464	ABM-CT-13494	8	7/16"	.3971"	.5050"	5-3/16"	7-3/16"
ABM-CT-13435	ABM-CT-13465	ABM-CT-13495	9	9/16"	.4805"	.6066"	6-1/16"	8-5/16"
ABM-CT-13436	ABM-CT-13466	ABM-CT-13496	10	5/8"	.5799"	.7216"	6-13/16"	9-5/16"
ABM-CT-13437	ABM-CT-13467	ABM-CT-13497	11	3/4"	.7060"	.8780"	8-1/4"	11-1/4"
ABM-CT-13438	ABM-CT-13468	ABM-CT-13498	12	7/8"	.8420"	1.0500"	10"	13-5/8"
ABM-CT-13439	ABM-CT-13469	ABM-CT-13499	13	1-1/4"	1.0090"	1.2590"	12"	16"
ABM-CT-13440	ABM-CT-13470	ABM-CT-13500	14	1-1/2"	1.2500"	1.5420"	14"	18-1/4"

Sets				
Straight Flute Item Code No.	Spiral Flute Item Code No.	Helical Flute Item Code No.	Size	No. of Pcs. in Sets
ABM-CT-13520	ABM-CT-13530	ABM-CT-13540	7/0 to 0	7
ABM-CT-13521	ABM-CT-13531	ABM-CT-13541	0 to 5	6
ABM-CT-13522	ABM-CT-13532	ABM-CT-13542	0 to 10	11
ABM-CT-13523	ABM-CT-13533	ABM-CT-13543	7/0 to 10	17



Morse Taper Reamer (Socket Reamer) (Morse Taper Finishing / Roughing Reamer) ANSI BS94.2

- Available in Straight Flute and Spiral Flute.
- Used for Finishing.
- Available in Straight Shank or Taper Shank.
- Taper Shanks is used for production Machine reaming of Tapered holes for morse Taper Shanks.
- Straight Shank is used for finishing or removal of burs and nicks in machine spindles.
- Made from High Speed Steel.
- Square end on straight shank allows reamer to be held in a Tap Wrench.
- Available in Roughing and Finishing Reamer.

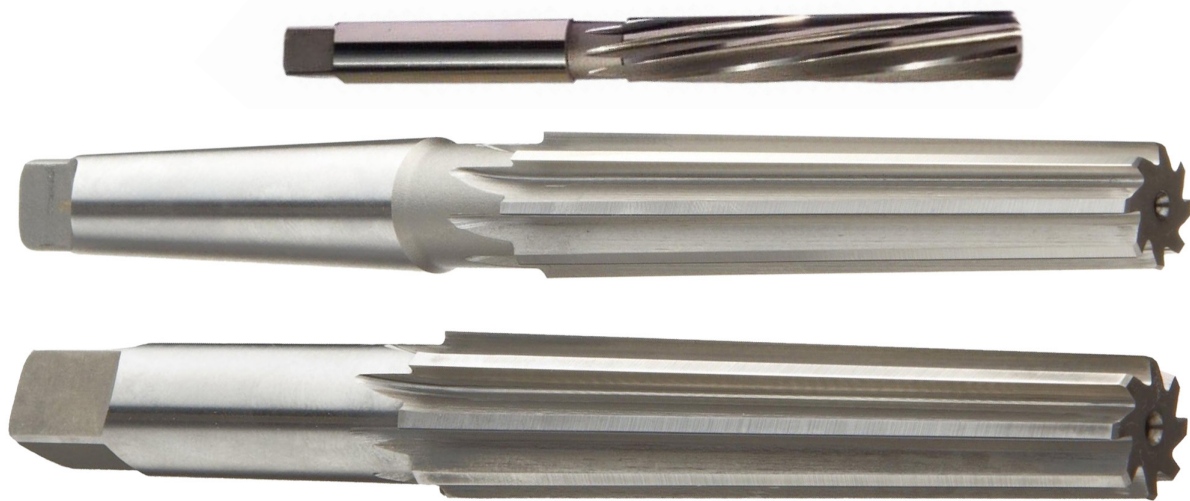

Hand Type Item Code No.	Machine Type Item Code No.	No of Morse Taper	Diameter of Reamer		Flute Length	Overall Length	
			Small End	Large End		Hand Type	Machine Type
ABM-CT-13220	ABM-CT-13226	0	.2503"	.3674"	2-1/4"	3-3/4"	5-11/32"
ABM-CT-13221	ABM-CT-13227	1	.3674"	.5170"	3"	5"	6-5/16"
ABM-CT-13222	ABM-CT-13228	2	.5696"	.7444"	3-1/2"	6"	7-3/8"
ABM-CT-13223	ABM-CT-13229	3	.7748"	.9881"	4-1/4"	7-1/4"	8-7/8"
ABM-CT-13224	ABM-CT-13230	4	1.0167"	1.2893"	5-1/4"	8-1/2"	10-7/8"
ABM-CT-13225	ABM-CT-13231	5	1.4717"	1.8005"	6-1/4"	9-3/4"	13-1/8"

While placing order please mention Roughing / Finishing Reamer
Also mention Straight or Spiral Flute

Taper Pipe Reamers ANSI B94.2

- Designed for reaming holes to be tapped with american Standard Taper Pipe Taps (NPT).
- 3/4" Taper per foot.
- Provided with Squared shank but generally used by hand.
- Available with Straight or Spiral flutes and Square Shank.
- Made from High Speed Steel.



Straight Flute Item Code No.	Spiral Flute Item Code No.	NPT Size	Flute Length	Nominal Diameter		Overall Length
				Large End	Small End	
ABM-CT-13570	ABM-CT-13590	1/8"	3/4"	.362"	.316"	2-1/8"
ABM-CT-13571	ABM-CT-13591	1/4"	1-1/16"	.472"	.406"	2-7/16"
ABM-CT-13572	ABM-CT-13592	3/8"	1-1/16"	.606"	.540"	2-9/16"
ABM-CT-13573	ABM-CT-13593	1/2"	1-3/8"	.751"	.665"	3-1/8"
ABM-CT-13574	ABM-CT-13594	3/4"	1-3/8"	.962"	.876"	3-1/4"
ABM-CT-13575	ABM-CT-13595	1"	1-3/4"	1.212"	1.103"	3-3/4"
ABM-CT-13576	ABM-CT-13596	1-1/4"	1-3/4"	1.553"	1.444"	4"
ABM-CT-13577	ABM-CT-13597	1-1/2"	1-3/4"	1.793"	1.684"	4-1/4"
ABM-CT-13578	ABM-CT-13598	2"	1-3/4"	2.268"	2.159"	4-1/2"

Sets			
Straight Flute Item Code No.	Spiral Flute Item Code No.	Size	No. of Pcs. in Sets
ABM-CT-13610	ABM-CT-13612	3/8", 1/2", 3/4" and 1"	4
ABM-CT-13611	ABM-CT-13613	1/4", 3/8", 1/2", 3/4" and 1"	5

Single Angle Shank Type Cutter (Chamfer Cutter) INVERTED DOVETAIL CUTTERS / CHAMFER CUTTER DIN 1833

- Use for chamfers and other angular Milling Operations.
- Available with included angles of 45° and 60°.
- Made of High Speed Steel.
- Designed to take the place of Arbor Type Cutters.
- Provided with Weldon shanks.
- Can be used both in manual and CNC Machines.
- Suitable for use in a wide range of Ferrous and Non-Ferrous Materials.
- Type B,D,F which is best described as umbrella shaped.

Inches Size						
45° Item Code No.	60° Item Code No.	Size	Cutter Width		Shank Dia.	Overall length
			45°	60°		
ABM-CT-13020	ABM-CT-13024	1/2"	1/8"	7/32"	3/8"	2-1/8"
ABM-CT-13021	ABM-CT-13025	3/4"	3/16"	5/16"	3/8"	2-1/8"
ABM-CT-13022	ABM-CT-13026	1"	5/16"	7/16"	1/2"	2-1/2"
ABM-CT-13023	ABM-CT-13027	1-1/2"	1/2"	5/8"	3/4"	2-3/4"

mm Sizes						
45° Item Code No.	60° Item Code No.	Cutter Width		Cutter Dia.	Shank Dia.	No. of Teeth
		45°	60°			
ABM-CT-12985	ABM-CT-12990	4	6.3	16	12	6
ABM-CT-12986	ABM-CT-12991	5	8	20	12	8
ABM-CT-12987	ABM-CT-12992	6.3	10	25	12	10
ABM-CT-12988	ABM-CT-12993	8	12.5	32	16	12
ABM-CT-12989	ABM-CT-12994	10	16	40	16	14



Dovetail Milling Cutter (Single Angle Dovetail Cutter) Single Angle Shank Type Cutter - As per ANSI/ ASME B94.19

- Use to produce Dovetail slide ways in Machine Tool Tables, Jigs and Fixtures.
- Designed to take the place of Arbor Type Cutters.
- Provided with Weldon shanks.
- Can be used both in manual and CNC Machines.
- Suitable for use in a wide range of Ferrous and Non-Ferrous Materials.
- Available in 45° or 60°.
- Made of High Speed Steel.
- Type A,C,E which is best described as an inside out umbrella shape.
- Sets also available as per customer requirements.



45° Item Code No.	60° Item Code No.	Size	Cutter Width		Shank Dia.	Overall length
			45°	60°		
ABM-CT-13000	ABM-CT-13008	3/8"	1/8"	3/16"	3/8"	2-1/8"
ABM-CT-13001	ABM-CT-13009	1/2"	5/32"	1/4"	3/8"	2-1/8"
ABM-CT-13002	ABM-CT-13010	3/4"	1/4"	5/16"	3/8"	2-1/8"
ABM-CT-13003	ABM-CT-13011	1"	1/4"	7/16"	1/2"	2-1/2"
ABM-CT-13004	ABM-CT-13012	1-3/8"	7/16"	9/16"	5/8"	2-7/8"
ABM-CT-13005	ABM-CT-13013	1-7/8"	9/16"	13/16"	7/8"	3-1/4"
ABM-CT-13006	ABM-CT-13014	2-1/4"	5/8"	1-1/16"	1"	3-3/4"
ABM-CT-13007	ABM-CT-13015	2-1/2"	3/4"	1-1/8"	1"	3-3/4"

Double Angle Shank Type Cutters

- High-speed steel tools are good for most general purpose applications, offering a combination of hardness and toughness for wear resistance.
- Uncoated end mills feature just the base substrate without any additional treatment or coatings and are suitable for a wide range of applications.
- For milling a double angle cut in one pass.



60° Item Code No.	90° Item Code No.	Cutter Dia.	Face Width		Shank Dia	Overall length	
			60°	90°		60°	90°
ABM-CT-14190	ABM-CT-14200	3/4"	3/16"	1/4"	3/8"	2-3/8"	2-7/16"
ABM-CT-14191	ABM-CT-14201	1"	5/16"	3/8"	1/2"	2-17/32"	2-9/32"
ABM-CT-14192	ABM-CT-14202	1-3/8"	7/16"	1/2"	5/8"	3-7/32"	3-9/32"
ABM-CT-14193	ABM-CT-14203	1-1/2"	1/2"	9/16"	5/8"	3-3/8"	3-7/16"
ABM-CT-14194	ABM-CT-14204	1-7/8"	5/8"	5/8"	3/4"	3-25/32"	3-25/32"
ABM-CT-14195	ABM-CT-14205	2-1/4"	3/4"	3/4"	7/8"	4-5/32"	4-5/32"

T Slot Cutters (Taper Shank and Parallel Shank)

- Used for T Shaped heads on existing Mill Slots.
- Available in both Taper Shank and Parallel Shank.
- Made of High Speed Steel.
- Used extensively for bolt slots.
- Provided with Bolt Shanks.



Dimension in mm

Parallel Shank Item Code No.	T Slot Size	Dia of Cutter	Width of Cutter	Overall Length	Dia. of Shank
ABM-CT-13038	6	12.5	6	57	10
ABM-CT-13039	8	16	8	62	10
ABM-CT-13040	10	18	8	70	12
ABM-CT-13041	12	21	9	74	12
ABM-CT-13042	14	25	11	82	16
ABM-CT-13043	18	32	14	90	16
ABM-CT-13044	22	40	18	108	25
ABM-CT-13045	28	50	22	124	32
ABM-CT-13046	36	60	28	139	32

While placing order please mention Left or Right Hand

Taper Shank Item Code No.	T Slot Size	Dia of Cutter	Width of Cutter	MT Shank	Overall Length
ABM-CT-13058	6	12.5	6	MT 2	93
ABM-CT-13059	8	16	8	MT 2	93
ABM-CT-13060	10	18	8	MT 2	93
ABM-CT-13061	12	21	9	MT 2	98
ABM-CT-13062	14	25	11	MT 2	104
ABM-CT-13063	18	32	14	MT 2	132
ABM-CT-13064	22	40	18	MT 3	144
ABM-CT-13065	28	50	22	MT 4	181
ABM-CT-13066	36	60	28	MT 4	200

While placing order please mention Left or Right Hand

Dimension in Inches

Parallel Shank Item Code No.	T Slot Size	Dia of Cutter	Width of Cutter	Neck Dia.	Shank	Nof of Teeth	Overall Length
ABM-CT-14260	1/4	9/16	15/64	17/64	1/2	8	2-19/32
ABM-CT-14261	5/16	21/32	17/64	21/64	1/2	8	2-11/16
ABM-CT-14262	3/8	25/32	21/64	13/32	3/4	8	3-1/4
ABM-CT-14263	1/2	31/32	25/64	17/32	3/4	8	3-7/16
ABM-CT-14264	5/8	1-1/4	31/64	21/32	1	10	3-15/16
ABM-CT-14265	3/4	1-15/32	5/8	25/32	1	10	4-7/16
ABM-CT-14266	1	1-27/32	53/64	1-1/32	1-1/4	10	4-13/16
ABM-CT-14267	1-1/4	2-7/32	1-3/32	1-9/32	1-1/4	12	5-3/8

While placing order please mention Left or Right Hand

Face Mill Cutters

APKT Inserts

- Good impact resistance and Durable in use.
- High strength and hardness.
- The rotary and milling feed rates 3 times more than normal milling cutter.
- Processing range: roughing, plane processing, groove cut, side processing, stairs processing.
- Ideal tool for heavy CNC milling cutting.

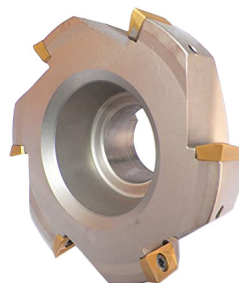

Item Code No.	No of Flutes	Dia mm	Tool Holding Bore mm	Height mm	Insert
ABM-CT-8190	6	40	16	40	APKT 100305
ABM-CT-8191	6	50	22	40	APKT 100305
ABM-CT-8192	6	63	22	40	APKT 100305
ABM-CT-8193	6	80	27	50	APKT 100305
ABM-CT-8194	6	100	32	50	APKT 100305

Radius Shank Type Cutters

Concave & Convex

- To be used in manual and NC Machining Centers.
- These cutters are preferred over form relief type cutters for Milling Female Half Circles.
- Full radius design with a weldon shank.
- Can be resharpened by grinding the face of the teeth without changing the form.

Concave Item Code No.	Radius	Cutter Dia.	Shank Dia.	No. of Flutes	Overall Length
ABM-CT-14220	1/32"	3/4"	1/2"	6	3"
ABM-CT-14221	1/16"	3/4"	1/2"	6	3"
ABM-CT-14222	3/32"	3/4"	1/2"	6	3"
ABM-CT-14223	1/8"	1"	3/4"	6	3-1/2"
ABM-CT-14224	5/32"	1"	3/4"	6	3-1/2"
ABM-CT-14225	3/16"	1"	3/4"	6	3-1/2"
ABM-CT-14226	1/4"	1-1/4"	3/4"	4	3-1/4"
ABM-CT-14227	5/16"	1-1/4"	3/4"	4	4"
ABM-CT-14228	3/8"	1-1/2"	3/4"	4	4-3/16"

Convex Item Code No.	Radius	Cutter Dia.	Shank Dia.	No. of Flutes	Overall Length
ABM-CT-14240	1/32"	3/4"	1/2"	6	3"
ABM-CT-14241	1/16"	3/4"	1/2"	6	3"
ABM-CT-14242	3/32"	7/8"	1/2"	6	3"
ABM-CT-14243	1/8"	1-1/4"	3/4"	6	3-1/2"
ABM-CT-14244	5/32"	1-5/16"	3/4"	6	3-1/2"
ABM-CT-14245	3/16"	1-3/8"	3/4"	6	3-1/2"
ABM-CT-14246	1/4"	1-1/2"	3/4"	4	4"
ABM-CT-14247	5/16"	1-5/8"	3/4"	4	4"
ABM-CT-14248	3/8"	1-3/4"	3/4"	4	4"

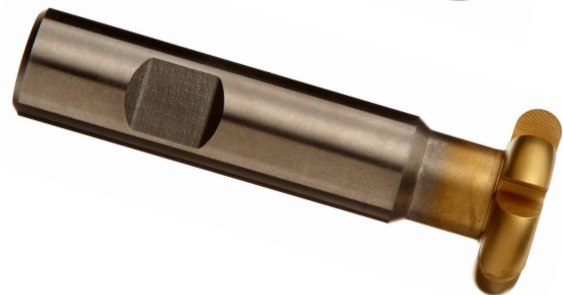
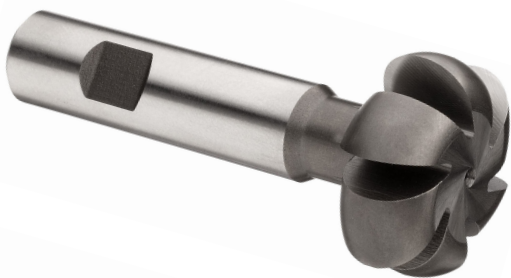

Woodruff Cutter (Woodruff Key Slot Cutter and Woodruff Key Seat Cutter)

- The woodruff key seat cutter is a circular cutter integral with a parallel shank for holding and driving having definite diameter and width with sides slightly concave designed for cutting seating in shafts for woodruff keys.
- Available in HSS M2 quality.

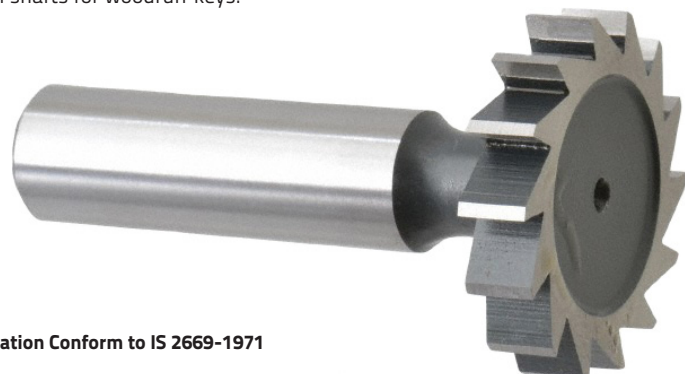

Specification Conform to IS 2669-1971

Item Code No.	Dia mm	Width of mm	Dia of Shank mm	Overall Length mm	Woodruff Key to IS 2294
ABM-CT-13090	10.50	2	6	50	2 x 3.7
ABM-CT-13091	10.50	2.50	6	50	2.5 x 3.7
ABM-CT-13092	10.50	3	6	50	3 x 3.7



Specification Conform to IS 2669-1971 (Specification in mm)					
Item Code No.	Dia mm	Width of mm	Dia of Shank mm	Overall Length mm	Woodruff Key to IS 2294
ABM-CT-13093	13.50	3	10	56	3 x 5
ABM-CT-13094	13.50	4	10	56	4 x 5
ABM-CT-13095	16.50	3	10	56	3 x 6.5
ABM-CT-13096	16.50	4	10	56	4 x 6.5
ABM-CT-13097	16.50	5	10	56	5 x 6.5
ABM-CT-13098	19.50	4	10	56	4 x 7.5
ABM-CT-13099	19.50	5	10	56	5 x 7.5
ABM-CT-13100	19.50	6	10	63	6 x 7.5
ABM-CT-13101	22.50	5	10	63	5 x 9
ABM-CT-13102	22.50	6	10	63	6 x 9
ABM-CT-13103	22.50	8	10	63	8 x 9
ABM-CT-13104	25.50	6	10	63	6 x 10
ABM-CT-13105	28.50	6	10	63	6 x 11
ABM-CT-13106	28.50	8	10	63	8 x 11
ABM-CT-13107	28.50	10	12	71	10 x 11
ABM-CT-13108	32.50	8	10	63	8 x 13
ABM-CT-13109	32.50	10	12	71	10 x 13
ABM-CT-13110	45.50	10	12	71	10 x 16

Specification Conform to BS 122 - 1953 Part 1 (Specification in Inches)					
Item Code No.	BS Cutter & Key No	Diameter of Cutter (Min)	Width of Cutter	Overall Length	Dia of Shank
ABM-CT-13130	204	0.505	0.061	2	1/2
ABM-CT-13131	304	0.505	0.093	2	1/2
ABM-CT-13132	404	0.505	0.124	2	1/2
ABM-CT-13133	305	0.630	0.093	2	1/2
ABM-CT-13134	405	0.630	0.124	2	1/2
ABM-CT-13135	505	0.630	0.155	2	1/2
ABM-CT-13136	406	0.755	0.124	2-1/4	1/2
ABM-CT-13137	506	0.755	0.155	2-1/4	1/2
ABM-CT-13138	606	0.755	0.187	2-1/4	1/2
ABM-CT-13139	507	0.880	0.155	2-1/2	1/2
ABM-CT-13140	607	0.880	0.187	2-1/2	1/2
ABM-CT-13141	807	0.880	0.249	2-1/2	1/2
ABM-CT-13142	608	1.005	0.187	2-3/4	1/2
ABM-CT-13143	808	1.005	0.249	2-3/4	1/2
ABM-CT-13144	1008	1.005	0.311	2-3/4	1/2
ABM-CT-13145	609	1.130	0.187	2-3/4	1/2
ABM-CT-13146	809	1.130	0.249	2-3/4	1/2
ABM-CT-13147	1009	1.130	0.311	2-3/4	1/2
ABM-CT-13148	810	1.255	0.249	2-3/4	1/2
ABM-CT-13149	1010	1.255	0.311	2-3/4	1/2
ABM-CT-13150	1210	1.255	0.374	2-3/4	1/2
ABM-CT-13151	1011	1.380	0.311	3	1/2
ABM-CT-13152	1211	1.380	0.374	3	1/2
ABM-CT-13153	812	1.505	0.249	3	1/2
ABM-CT-13154	1012	1.505	0.311	3	1/2
ABM-CT-13155	1212	1.505	0.374	3	1/2

Valve Seat & Face Cutter Sets

Professional 45 Degree



Available in Carbon Steel, HSS & Carbide

- Manufactured from high grade carbon steel, properly hardened & tempered.
- The cutting edge of all the cutters are accurately ground for best results.
- Sets supplied in fine finished wooden box.
- Suitable for re-cutting inlet/exhaust valve seats concentric to the valve guides.
- Features cutting blades, expandable pilots and double end cutters for increased application.

Item Code No.	No of Pcs in Each Set	Sizes of Valve Seat & Face Cutter Included Inches
ABM-IMT-8441	5 Pcs Set	CUTTERS : 42.5, 40, 37.5, 35 & 32.5 mm THREADED SPINDLE : 6.5, 7, 7.5, 8, 8.5 mm TOMMY BAR : M8
ABM-IMT-8442	13 Pcs Set	CUTTERS : 30, 32, 37.5, 40, 42.5, 45, 47.5, 50, 52.5, 55, 57.5 & mm THREADED SPINDLE : 6, 6.5, 7, 7.5, 8, 8.5, 9, 9.5, 10, 10.5, 11, 11.5 & 12 mm TOMMY BAR : M8

Valve Seat & Face Cutter Sets



Available in Carbon Steel, HSS & Carbide

- Manufactured from high grade carbon steel, properly hardened & tempered.
- The cutting edge of all the cutters are accurately ground for best results.
- Sets supplied in fine finished wooden box.
- Suitable for re-cutting inlet/exhaust valve seats concentric to the valve guides.
- Features cutting blades, expandable pilots and double end cutters for increased application.

Item Code No.	No of Pcs in Each Set	Sizes of Valve Seat & Face Cutter Included Inches
ABM-IMT-8431	3 Pcs Set	1-5/16 & 1-7/16 (45°) (Supplied with 2 Nos. Guides, 1 Nos. Each Handle, Rod & Small Pin) Size of Bore Cutters Included 1-3/8" (20°)
ABM-IMT-8432	4 Pcs Set	1-5/16, 1-7/16 & 1-3/8 (45°) (Supplied with 2 Nos. Guides, 1 Nos. Each Handle, Rod & Small Pin) Size of Bore Cutters Included 1-3/8" (20°)
ABM-IMT-8433	10 Pcs Set	1-3/16, 1-1/4, 1-5/16, 1-3/8, 1-1/2, 1-11/16, 1-1/4 & 1-9/16 (20°), 1-3/4 (45°) & 1-11/16 (30°) (Supplied with 8 Nos. Guides, 2 Nos. Each Handle, 2 Rods & Small Pin) Size of Bore Cutters Included 1-1/4" & 1-9/16" (20°)
ABM-IMT-8434	12 Pcs Set	1-3/16, 1-1/4, 1-5/16, 1-3/8, 1-1/2, 1-11/16, 1-1/4 & 1-9/16 (20°), 1-3/4 (45°), 1-11/16 (30°) & 2-1/16 (45°) (Supplied with 8 Nos. Guides, 2 Nos. Each Handle, 2 Rods & Small Pin) Size of Bore Cutters Included 1-1/4", 1-9/16" (20°) & 1-3/4 (45°)
ABM-IMT-8435	15 Pcs Set	1-3/16, 1-1/4, 1-5/16, 1-3/8, 1-1/2, 1-11/16, 1-1/4 & 1-9/16 (20°), 1-3/4 (45°), 1-11/16 (30°) & 2-1/16, 1-7/16, 1-5/8 & 2-1/8 (45°) (Supplied with 8 Nos. Guides, 2 Nos. Each Handle, 2 Rods & Small Pin) Size of Bore Cutters Included 1-1/4", 1-9/16" (20°) & 1-3/4 (45°)
ABM-IMT-8436	20 Pcs Set	1-3/16, 1-1/4, 1-5/16, 1-3/8, 1-1/2, 1-11/16, 1-1/4 & 1-9/16 (20°), 1-3/4 (45°), 1-11/16 (30°) & 2-1/16, 1-7/16, 1-5/8, 2-1/8, 1-1/8, 1-7/8 & 2-1/4 (45°) (Supplied with 8 Nos. Guides, 2 Nos. Each Handle, 2 Rods & Small Pin) Size of Bore Cutters Included 1-1/4", 1-9/16" (20°), 1-3/4 & 2"(45°)

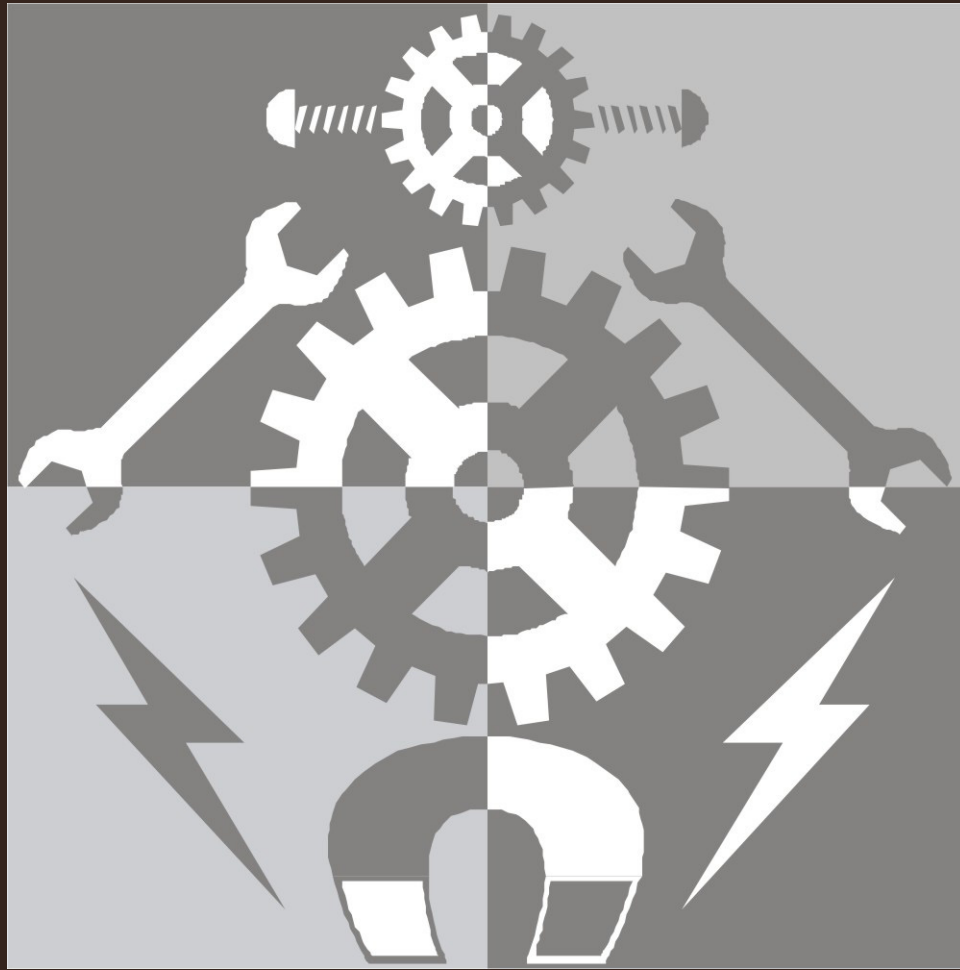

A B M T O O L S

79A, Pocket GG-1, Vikas Puri,
New Delhi - 110018, India

Mobile : +91 9891027608 / 9871263436 / 9891044387
(Whatsapp)

e-mail: sales@abmtools.com
abmtools@gmail.com

www.abmtools.com
www.abmtools.net



www.abmtools.com